

Dell B3465dn-dnf Laser MFP

User's Guide



March 2014

www.dell.com | dell.com/support/printers

Trademarks

Information in this document is subject to change without notice.

© 2014 Dell, Inc. All rights reserved.

Reproduction of this material in any manner whatsoever without the written permission of Dell Inc. is strictly forbidden.

Trademarks used in this text: *Dell*, the *DELL* logo, *Inspiron*, *Dell Precision*, *Dimension*, *OptiPlex*, *Latitude*, *PowerEdge*, *PowerVault*, *PowerApp*, and *Dell OpenManage* are trademarks of Dell Inc.; *Intel*, *Pentium*, and *Celeron* are registered trademarks of Intel Corporation; *Microsoft* and *Windows* are registered trademarks of Microsoft Corporation; *AirPrint* and the *AirPrint* logo are trademarks of Apple, Inc.

Other trademarks and trade names may be used in this document to refer to the entities claiming the marks and names of their products. Dell Inc. disclaims any proprietary interest in trademarks and trade names other than its own.

Contents

- Safety information.....7**
- Learning about the printer.....9**
 - Finding information about the printer.....9
 - Selecting a location for the printer.....10
 - Printer configurations.....11
 - Using the Embedded Web Server.....13
 - Understanding the basic functions of the scanner.....14
 - Using the ADF and scanner glass.....14
- Understanding the printer control panel.....15**
 - Using the printer control panel.....15
 - Understanding the colors of the Sleep button and indicator lights.....15
 - Understanding the home screen.....16
 - Using the touch-screen buttons.....18
- Setting up and using the home screen applications.....20**
 - Finding the IP address of the computer.....20
 - Finding the IP address of the printer.....20
 - Accessing the Embedded Web Server.....20
 - Customizing the home screen.....21
 - Understanding the different applications.....21
 - Activating the home screen applications.....22
 - Finding information about the home screen applications.....22
 - Setting up Forms and Favorites22
 - Setting up Card Copy22
 - Using MyShortcut23
 - Setting up Multi Send24
 - Setting up Scan to Network24
 - Setting up Remote Operator Panel.....25
 - Exporting and importing a configuration.....25
- Additional printer setup.....27**
 - Installing internal options.....27
 - Installing hardware options.....42
 - Setting up the printer software.....44

Attaching cables.....45
Networking.....46
Verifying printer setup.....50

Loading paper and specialty media.....51

Setting the paper size and type.....51
Configuring Universal paper settings.....51
Loading trays.....51
Loading the multipurpose feeder.....56
Using the standard bin and paper stop.....61
Linking and unlinking trays.....62

Paper and specialty media guide.....65

Using specialty media.....65
Paper guidelines.....67
Supported paper sizes, types, and weights.....70

Printing.....74

Printing forms and a document.....74
Printing from a flash drive or mobile device.....75
Printing confidential and other held jobs.....78
Printing information pages.....80
Canceling a print job.....80

Copying.....81

Making copies.....81
Copying photos.....82
Copying on specialty media.....82
Customizing copy settings.....83
Placing information on copies.....89
Canceling a copy job.....89
Understanding the copy options.....90

E-mailing.....92

Setting up the printer to e-mail.....92
Creating an e-mail shortcut.....93
E-mailing a document.....94
Customizing e-mail settings.....95

Canceling an e-mail.....	96
Understanding the e-mail options.....	96
Faxing.....	99
Setting up the printer to fax.....	99
Sending a fax.....	113
Creating shortcuts.....	116
Customizing fax settings.....	116
Canceling an outgoing fax.....	118
Holding and forwarding faxes.....	118
Understanding the fax options.....	119
Scanning.....	122
Using Scan to Network.....	122
Scanning to an FTP address.....	122
Scanning to a computer or flash drive.....	124
Understanding the scan options.....	126
Understanding the printer menus.....	129
Menus list.....	129
Paper menu.....	130
Reports Menu.....	140
Network/Ports menu.....	141
Security menu.....	149
Settings menu.....	154
Help menu.....	199
Saving money and the environment.....	200
Saving paper and toner.....	200
Saving energy.....	200
Recycling.....	204
Securing the printer.....	205
Statement of Volatility.....	205
Erasing volatile memory.....	205
Erasing non-volatile memory.....	206
Erasing printer hard disk memory.....	206
Configuring printer hard disk encryption.....	207

Finding printer security information.....208

Maintaining the printer.....209

Cleaning printer parts.....209
 Checking the status of parts and supplies.....211
 Estimated number of remaining pages.....211
 Ordering supplies.....211
 Storing supplies.....212
 Replacing supplies.....213
 Moving the printer.....219

Managing the printer.....221

Managing printer messages.....221
 Accessing Status Monitor Center.....221
 Checking the virtual display.....221
 Setting up e-mail alerts.....222
 Viewing reports.....222
 Configuring supply notifications from the Embedded Web Server.....222
 Restoring factory default settings.....223

Clearing jams.....224

Avoiding jams.....224
 Understanding jam messages and locations.....225
 [x]-page jam, open automatic feeder top cover. [28y.xx].....226
 [x]-page jam, clear standard bin. [20y.xx].....227
 [x]-page jam, open rear door. [20y.xx].....227
 [x]-page jam, open front door. [20y.xx].....229
 [x]-page jam, remove tray 1 to clear duplex. [23y.xx].....232
 [x]-page jam, clear manual feeder. [25y.xx].....233
 [x]-page jam, open tray [x]. [24y.xx].....234
 [x]-page jam, remove all pages from the output bin. Leave paper in bin. [45y.xx].....235

Troubleshooting.....240

Understanding the printer messages.....240
 Solving printer problems.....254
 Solving print problems.....261
 Solving copy problems.....286

Solving fax problems.....290
Solving scanner problems.....296
Solving home screen application problems.....301
Embedded Web Server does not open.....301
Contacting technical support.....302

Appendix.....303

Index.....305

Safety information

Connect the power cord to a properly grounded electrical outlet that is near the product and easily accessible.

Do not place or use this product near water or wet locations.

 **CAUTION—POTENTIAL INJURY:** This product uses a laser. Use of controls or adjustments or performance of procedures other than those specified herein may result in hazardous radiation exposure.

This product uses a printing process that heats the print media, and the heat may cause the media to release emissions. You must understand the section in your operating instructions that discusses the guidelines for selecting print media to avoid the possibility of harmful emissions.

 **CAUTION—POTENTIAL INJURY:** The lithium battery in this product is not intended to be replaced. There is a danger of explosion if a lithium battery is incorrectly replaced. Do not recharge, disassemble, or incinerate a lithium battery. Discard used lithium batteries according to the manufacturer's instructions and local regulations.

 **CAUTION—HOT SURFACE:** The inside of the printer might be hot. To reduce the risk of injury from a hot component, allow the surface to cool before touching it.

 **CAUTION—POTENTIAL INJURY:** The printer weight is greater than 18 kg (40 lb) and requires two or more trained personnel to lift it safely.

 **CAUTION—POTENTIAL INJURY:** Before moving the printer, follow these guidelines to avoid personal injury or printer damage:

- Turn the printer off using the power switch, and then unplug the power cord from the electrical outlet.
- Disconnect all cords and cables from the printer before moving it.
- If an optional tray is installed, then remove it from the printer. To remove the optional tray, slide the latch on the right side of the tray toward the front of the tray until it *clicks* into place.
- Use the handholds located on both sides of the printer to lift it.
- Make sure your fingers are not under the printer when you set it down.
- Before setting up the printer, make sure there is adequate clearance around it.

Use only the power cord provided with this product or the manufacturer's authorized replacement.

Use only the telecommunications (RJ-11) cord provided with this product or a 26 AWG or larger replacement when connecting this product to the public switched telephone network.

 **CAUTION—SHOCK HAZARD:** If you are accessing the controller board or installing optional hardware or memory devices sometime after setting up the printer, then turn the printer off, and unplug the power cord from the electrical outlet before continuing. If you have any other devices attached to the printer, then turn them off as well, and unplug any cables going into the printer.

 **CAUTION—SHOCK HAZARD:** Make sure that all external connections (such as Ethernet and telephone system connections) are properly installed in their marked plug-in ports.

This product is designed, tested, and approved to meet strict global safety standards with the use of specific manufacturer's components. The safety features of some parts may not always be obvious. The manufacturer is not responsible for the use of other replacement parts.

 **CAUTION—POTENTIAL INJURY:** Do not cut, twist, bind, crush, or place heavy objects on the power cord. Do not subject the power cord to abrasion or stress. Do not pinch the power cord between objects such as furniture and walls. If any of these things happen, a risk of fire or electrical shock results. Inspect the power cord regularly for signs of such problems. Remove the power cord from the electrical outlet before inspecting it.

Refer service or repairs, other than those described in the user documentation, to a service representative.

 **CAUTION—TIPPING HAZARD:** Floor-mounted configurations require additional furniture for stability. You must use either a printer stand or printer base if you are using multiple input options. If you purchased a multifunction printer (MFP) that scans, copies, and faxes, then you may need additional furniture. For more information, contact the place where you purchased the printer.

 **CAUTION—POTENTIAL INJURY:** To reduce the risk of equipment instability, load each tray separately. Keep all other trays closed until needed.

 **CAUTION—SHOCK HAZARD:** Do not use the fax feature during a lightning storm. Do not set up this product or make any electrical or cabling connections, such as the fax feature, power cord, or telephone, during a lightning storm.

 **CAUTION—SHOCK HAZARD:** To avoid the risk of electrical shock when cleaning the exterior of the printer, unplug the power cord from the electrical outlet and disconnect all cables from the printer before proceeding.

SAVE THESE INSTRUCTIONS.

Learning about the printer

Finding information about the printer

What are you looking for?	Find it here
Initial setup instructions: <ul style="list-style-type: none"> • Connecting the printer • Installing the printer software 	Setup documentation—The setup documentation came with the printer.
Additional setup and instructions for using the printer: <ul style="list-style-type: none"> • Selecting and storing paper and specialty media • Loading paper • Configuring printer settings • Viewing and printing documents and photos • Setting up and using the printer software • Configuring the printer on a network • Caring for and maintaining the printer • Troubleshooting and solving problems 	<i>User's Guide</i> and <i>Quick Reference Guide</i> —The guides may be available on the <i>Software and Documentation</i> CD. For more information, visit our Web site at www.dell.com/support/manuals .
Instructions for: <ul style="list-style-type: none"> • Connecting the printer to an Ethernet network • Troubleshooting printer connection problems 	<i>Networking Guide</i> —Open the <i>Software and Documentation</i> CD, and then navigate to: Documentation > User's Guide and other publications > Networking Guide
Help using the printer software	Windows or Mac Help—Open a printer software program or application, and then click Help . Click  to view context-sensitive information. Notes: <ul style="list-style-type: none"> • Help is automatically installed with the printer software. • The printer software is located in the printer program folder or on the desktop, depending on your operating system.
The latest supplemental information, updates, and technical support: <ul style="list-style-type: none"> • Documentation • Driver downloads • Product upgrades • Service call and repair information • Order status • Live chat support • E-mail support • Voice support 	Dell support Web site— www.dell.com/support/printers Support telephone numbers and hours of operation for your country or region can be found on the support Web site. Have the following information ready when you contact support so that they may serve you faster: <ul style="list-style-type: none"> • Service tag • Express service Code Note: The service tag and express service code appear on labels located on your printer.

What are you looking for?	Find it here
<ul style="list-style-type: none"> • Software and Drivers—Certified drivers for your printer and installers for Dell printer software • Readme files—Last-minute technical changes, or advanced technical reference materials for experienced users or technicians 	<p><i>Software and Documentation CD</i></p>
<ul style="list-style-type: none"> • Supplies and accessories for your printer • Replacement cartridges 	<p>Dell printer supplies Web site—www.dell.com/printers You can purchase printer supplies online, by telephone, or in select retail stores.</p>
<ul style="list-style-type: none"> • Safety information for preparing to operate your printer • Regulatory information • Warranty information 	<p><i>Product Information Guide</i></p> <div data-bbox="1068 646 1263 928" style="text-align: center;"> </div> <p>Note: The <i>Product Information Guide</i> may not be available in your country or region.</p>

Selecting a location for the printer

CAUTION—POTENTIAL INJURY: The printer weight is greater than 18 kg (40 lb) and requires two or more trained personnel to lift it safely.

When selecting a location for the printer, leave enough room to open trays, covers, and doors. If you plan to install any options, then leave enough room for them also. It is important to:

- Set up the printer near a properly grounded and easily accessible electrical outlet.
- Make sure airflow in the room meets the latest revision of the ASHRAE 62 standard or the CEN Technical Committee 156 standard.
- Provide a flat, sturdy, and stable surface.
- Keep the printer:
 - Clean, dry, and free of dust.
 - Away from stray staples and paper clips.
 - Away from the direct airflow of air conditioners, heaters, or ventilators.
 - Free from direct sunlight and humidity extremes.
- Observe the recommended temperatures and avoid fluctuations:

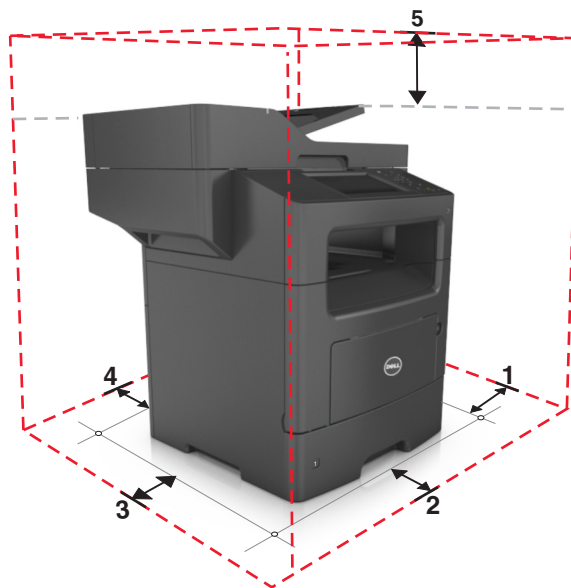

Ambient temperature	15.6 to 32.2°C (60 to 90°F)
Storage temperature	1 to 35°C (34 to 95°F)

- Allow the following recommended amount of space around the printer for proper ventilation:



1	Right side	304.8 mm (12 in.)
2	Front	508 mm (20 in.)
3	Left side	203.2 mm (8 in.)
4	Rear	203.2 mm (8 in.)
5	Top	800 mm (31.49 in.)

Printer configurations

-  **CAUTION—POTENTIAL INJURY:** To reduce the risk of equipment instability, load each tray separately. Keep all other trays closed until needed.
-  **CAUTION—TIPPING HAZARD:** Floor-mounted configurations require additional furniture for stability. You must use either a printer stand or printer base if you are using multiple input options. If you purchased a multifunction printer (MFP) that scans, copies, and faxes, then you may need additional furniture. For more information, contact the place where you purchased the printer.

Basic model

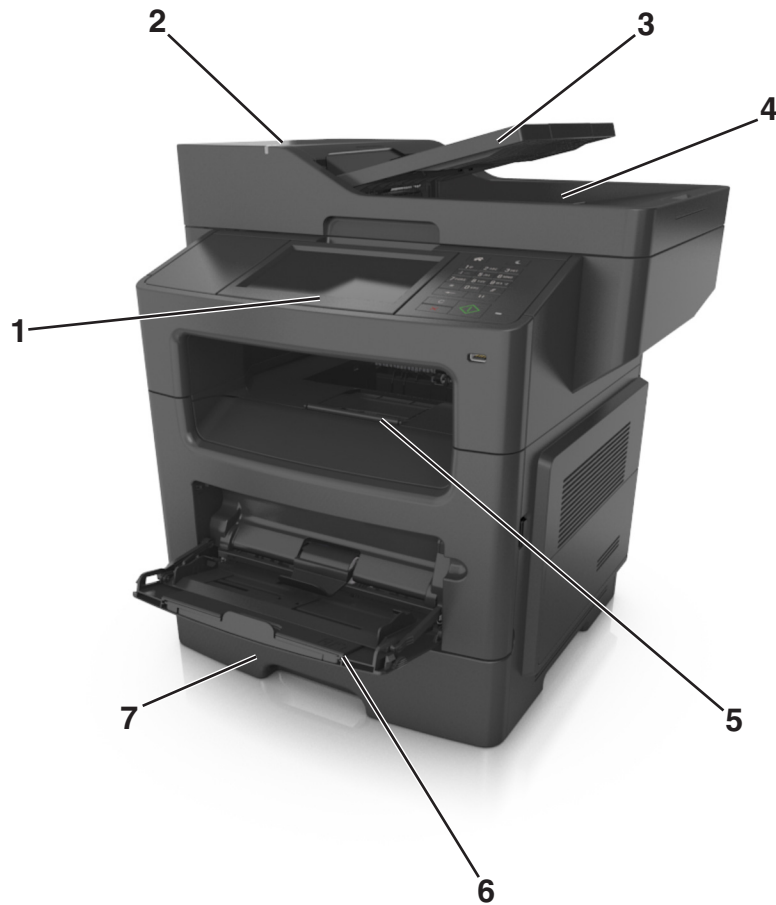

1	Display
2	Automatic document feeder (ADF)
3	ADF tray
4	ADF bin
5	Standard bin
6	Multipurpose feeder
7	Standard 550-sheet tray Note: A lockable 550-sheet tray is also available. For more information, contact the place where you purchased the printer.

Configured model

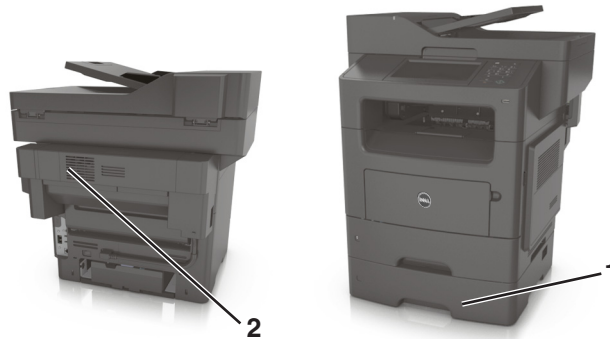

1	Optional 550-sheet tray
2	Optional stapler

Using the Embedded Web Server

Note: This feature is available only in network printers or printers connected to print servers.

If the printer is installed on a network, then you can use the Embedded Web Server to do the following:

- View the virtual display of the printer control panel.
- Check the status of the printer supplies.
- Configure supply notifications.
- Configure printer settings.
- Configure network settings.
- View reports.

To access the Embedded Web Server for your printer:

1 Obtain the printer IP address:

- From the TCP/IP section in the Network/Ports menu
- By printing a network setup page or menu settings page, and then finding the TCP/IP section

Notes:

- An IP address appears as four sets of numbers separated by periods, such as 123.123.123.123.
- If you are using a proxy server, then temporarily disable it to load the Web page correctly.

2 Open a Web browser, and then type the printer IP address in the address field.



3 Press **Enter**.

The Embedded Web Server page appears.

Understanding the basic functions of the scanner

- Make quick copies or set the printer to perform specific copy jobs.
- Send a fax using the printer control panel.
- Send a fax to multiple fax destinations at the same time.
- Scan documents and send them to your computer, an e-mail address, or an FTP destination.
- Scan documents and send them to another printer (PDF through an FTP).

Using the ADF and scanner glass

Automatic document feeder (ADF)	Scanner glass
 <p data-bbox="149 1087 753 1146">Use the ADF for multiple-page documents including two-sided (duplex) pages.</p>	 <p data-bbox="773 1087 1463 1180">Use the scanner glass for single-page documents, book pages, small items (such as postcards or photos), transparencies, photo paper, or thin media (such as magazine clippings).</p>

Using the ADF

When using the ADF:

- Load the document into the ADF tray faceup, short edge first.
- Load up to 50 sheets of plain paper into the ADF tray.
- Scan sizes from 105 x 148 mm (4.1 x 5.8 inches) wide to 216 x 368 mm (8.5 x 14.5 inches) long.
- Scan media weights from 52 to 120 g/m² (14–32 lb).
- Do not load postcards, photos, small items, transparencies, photo paper, or thin media (such as magazine clippings) into the ADF tray. Place these items on the scanner glass.

Using the scanner glass

When using the scanner glass:

- Place a document facedown on the scanner glass in the corner with the green arrow.
- Scan or copy documents up to 216 x 355.6 mm (8.5 x 14 inches) long.
- Copy books up to 25.3 mm (1 inch) thick.

Understanding the printer control panel

Using the printer control panel

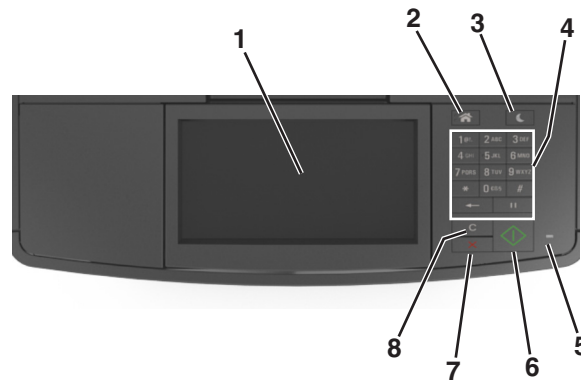

Use the		To
1	Display	<ul style="list-style-type: none"> View the printer status and messages. Set up and operate the printer.
2	Home button	Go to the home screen.
3	Sleep button	Enable Sleep mode or Hibernate mode. Do the following to wake the printer from Sleep mode: <ul style="list-style-type: none"> Press any hard button. Open a door or cover. Send a print job from the computer. Perform a power-on reset (POR) with the main power switch. Attach a device to the USB port on the printer.
4	Keypad	Enter numbers, letters, or symbols.
5	Indicator light	Check the status of the printer.
6	Start button	Start a job, depending on which mode is selected.
7	Cancel button	Stop all printer activity.
8	Clear All / Reset button	Reset the default settings of a function, such as printing, copying, or e-mailing.

Understanding the colors of the Sleep button and indicator lights

The colors of the Sleep button and indicator lights on the printer control panel signify a certain printer status or condition.

Indicator light	Printer status
Off	The printer is off or in Hibernate mode.
Blinking green	The printer is warming up, processing data, or printing.

Indicator light	Printer status
Solid green	The printer is on, but idle.
Blinking red	The printer requires user intervention.
Sleep button light	Printer status
Off	The printer is off, idle or in Ready state.
Solid amber	The printer is in Sleep mode.
Blinking amber	The printer is entering or waking from Hibernate mode.
Blinking amber for 0.1 second, then goes completely off for 1.9 seconds in a slow, pulsing pattern	The printer is in Hibernate mode.

Understanding the home screen

When the printer is turned on, the display shows a basic screen, referred to as the home screen. Touch the home screen buttons and icons to initiate an action such as copying, faxing, or scanning; to open the menu screen; or to respond to messages.

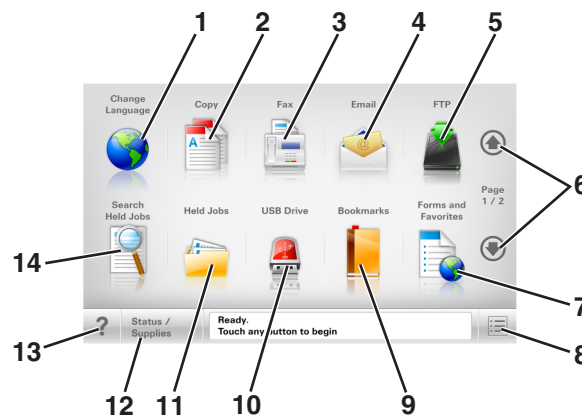

Note: Your home screen may vary depending on your home screen customization settings, administrative setup, and active embedded solutions.



Touch	To
1	Change Language Launch the Change Language pop-up window that lets you change the primary language of the printer.
2	Copy Access the Copy menus and make copies.
3	Fax Access the Fax menus and send fax.
4	E-mail Access the E-mail menus and send e-mails.
5	FTP Access the File Transfer Protocol (FTP) menus and scan documents directly to an FTP server.
6	Arrows Scroll up or down.
7	Forms and Favorites Quickly find and print frequently used online forms.
8	Menu icon Access the printer menus. Note: The menus are available only when the printer is in Ready state.

Touch		To
9	Bookmarks	Create, organize, and save a set of bookmarks (URL) into a tree view of folders and file links. Note: The tree view supports only bookmarks created from this function, and not from any other application.
10	USB Drive	View, select, print, scan, or e-mail photos and documents from a flash drive. Note: This icon appears only when you return to the home screen while a memory card or flash drive is connected to the printer.
11	Held Jobs	Display all current held jobs.
12	Status/Supplies	<ul style="list-style-type: none"> • Show a warning or error message whenever the printer requires intervention to continue processing. • Access the messages screen for more information on the message, and how to clear it.
13	Tips	Open a context-sensitive Help dialog.
14	Search held jobs	Search for one or more of the following items: <ul style="list-style-type: none"> • User name for held or confidential print jobs • Job names for held jobs, excluding confidential print jobs • Profile names • Bookmark container or print job names • USB container or print job names for supported file types

Features

Feature	Description
Menu trail line Example: <u>Menus</u> > <u>Settings</u> > <u>Copy Settings</u> > Number of Copies	A menu trail line is located at the top of each menu screen. This feature shows the path taken to arrive at the current menu. Touch any of the underlined words to return to that menu. Number of Copies is not underlined because it is the current screen. If you touch an underlined word on the “Number of Copies” screen before the number of copies is set and saved, then the selection is not saved, and it does not become the default setting.
Attendance message alert 	If an attendance message affects a function, then this icon appears and the red indicator light blinks.
Warning 	If an error condition occurs, then this icon appears.
Status message bar	<ul style="list-style-type: none"> • Show the current printer status such as Ready or Busy. • Show printer conditions such as Toner Low or Cartridge Low. • Show intervention messages so the printer can continue processing.

Feature	Description
Printer IP address Example: 123 . 123 . 123 . 123	The IP address of your network printer is located at the upper left corner of the home screen and appears as four sets of numbers separated by periods. You can use the IP address when accessing the Embedded Web Server so you can view and remotely configure printer settings even when you are not physically near the printer.

Using the touch-screen buttons

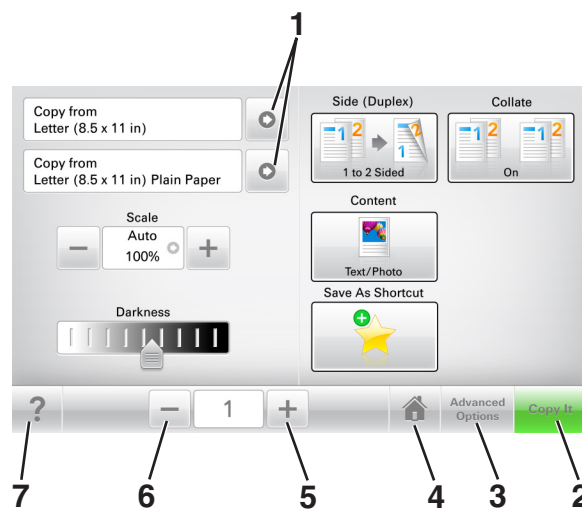

Note: Your home screen, icons, and buttons may vary, depending on your home screen customization settings, administrative setup, and active embedded solutions.



	Touch	To
1	Arrows	View a list of options.
2	Copy It	Print a copy.
3	Advanced Options	Select a copy option.
4	Home	Go to the home screen.
5	Increase	Select a higher value.
6	Decrease	Select a lower value.
7	Tips	Open a context-sensitive Help dialog.

Other touch-screen buttons

Touch	To
Accept 	Save a setting.

Touch	To
<p data-bbox="151 275 224 302">Cancel</p> 	<ul data-bbox="594 279 1393 352" style="list-style-type: none">• Cancel an action or a selection.• Exit a screen and return to the previous screen without saving changes.
<p data-bbox="151 447 215 474">Reset</p> 	<p data-bbox="578 447 878 474">Reset values on the screen.</p>

Setting up and using the home screen applications

Note: Your home screen may vary depending on your home screen customization settings, administrative setup, and active applications. Some applications are supported only in select printer models.

Finding the IP address of the computer

For Windows users

- 1 In the Run dialog box, type `cmd` to open the command prompt.
- 2 Type `ipconfig`, and then look for the IP address.

For Macintosh users

- 1 From System Preferences in the Apple menu, select **Network**.
- 2 Select your connection type, and then click **Advanced > TCP/IP**.
- 3 Look for the IP address.

Finding the IP address of the printer

Note: Make sure your printer is connected to a network or to a print server.

You can find the printer IP address:

- From the top left corner of the printer home screen.
- From the TCP/IP section in the Network/Ports menu.
- By printing a network setup page or menu settings page, and then finding the TCP/IP section.

Note: An IP address appears as four sets of numbers separated by periods, such as 123.123.123.123.

Accessing the Embedded Web Server

The Embedded Web Server is the printer Web page that lets you view and remotely configure printer settings even when you are not physically near the printer.

- 1 Obtain the printer IP address:
 - From the printer control panel home screen
 - From the TCP/IP section in the Network/Ports menu
 - By printing a network setup page or menu settings page, and then finding the TCP/IP section

Note: An IP address appears as four sets of numbers separated by periods, such as 123 . 123 . 123 . 123 .

- 2 Open a Web browser, and then type the printer IP address in the address field.
- 3 Press **Enter**.

Note: If you are using a proxy server, then temporarily disable it to load the Web page correctly.

Customizing the home screen

- 1 Open a Web browser, and then type the printer IP address in the address field.

Note: View the printer IP address on the printer home screen. The IP address appears as four sets of numbers separated by periods, such as 123.123.123.123.

- 2 Do one or more of the following:

- Show or hide the icons of basic printer functions.
 - a Click **Settings > General Settings > Home screen customization**.
 - b Select the check boxes to specify which icons appear on the home screen.

Note: If you clear a check box beside an icon, then the icon does not appear on the home screen.

- c Click **Submit**.
- Customize the icon for an application. For more information, see [“Finding information about the home screen applications” on page 22](#) or see the documentation that came with the application.

Understanding the different applications

Use	To
Card Copy	Scan and print both sides of a card on a single page. For more information, see “Setting up Card Copy” on page 22 .
Fax	Scan a document, and then send it to a fax number. For more information, see “Faxing” on page 99 .
Forms and Favorites	Quickly find and print frequently used online forms directly from the printer home screen. For more information, see “Setting up Forms and Favorites” on page 22 .
Multi Send	Scan a document, and then send it to multiple destinations. For more information, see “Setting up Multi Send” on page 24 .
MyShortcut	Create shortcuts directly on the printer home screen. For more information, see “Using MyShortcut” on page 23 .
Scan to E-mail	Scan a document, and then send it to an e-mail address. For more information, see “E-mailing” on page 92 .
Scan to Computer	Scan a document, and then save it to a predefined folder on a host computer. For more information, see “Setting up Scan to Computer” on page 125 .
Scan to FTP	Scan documents directly to a File Transfer Protocol (FTP) server. For more information, see “Scanning to an FTP address” on page 122 .
Scan to Network	Scan a document, and then send it to a network shared folder. For more information, see “Setting up Scan to Network” on page 24 .

Activating the home screen applications

Finding information about the home screen applications

Your printer comes with preinstalled home screen applications. Before you can use these applications, you must first activate and set up these applications using the Embedded Web Server. For more information on accessing the Embedded Web Server, see [“Accessing the Embedded Web Server” on page 20](#).

For detailed information on configuring and using the home screen applications, visit the Dell support Web site at www.dell.com/support/printers.

Setting up Forms and Favorites

Note: A later version of this *User's Guide* may contain a direct link to the *Administrator's Guide* of this application. To check for updates of this *User's Guide*, go to www.dell.com/support/manuals.

Use	To
	<p>Streamline work processes by letting you quickly find and print frequently used online forms directly from the printer home screen.</p> <p>Note: The printer must have permission to access the network folder, FTP site, or Web site where the bookmark is stored. From the computer where the bookmark is stored, use sharing, security, and firewall settings to allow the printer at least a <i>read</i> access. For help, see the documentation that came with your operating system.</p>

- 1 Open a Web browser, and then type the printer IP address in the address field.

Note: View the printer IP address on the printer home screen. The IP address appears as four sets of numbers separated by periods, such as 123.123.123.123.

- 2 Click **Settings > Apps > Apps Management > Forms and Favorites**.

- 3 Click **Add**, and then customize the settings.

Notes:

- See the mouse-over help beside each field for a description of the setting.
- To make sure the location settings of the bookmark are correct, type the correct IP address of the host computer where the bookmark is located. For more information on obtaining the IP address of the host computer, see [“Finding the IP address of the computer” on page 20](#).
- Make sure the printer has access rights to the folder where the bookmark is located.

- 4 Click **Apply**.

To use the application, touch **Forms and Favorites** on the printer home screen, and then navigate through form categories, or search for forms based on a form number, name, or description.

Setting up Card Copy

Note: A later version of this *User's Guide* may contain a direct link to the *Administrator's Guide* of this application. To check for updates of this *User's Guide*, go to www.dell.com/support/manuals.

Use	To
	<p>Quickly and easily copy insurance, identification, and other wallet-size cards.</p> <p>You can scan and print both sides of a card on a single page, saving paper and showing the information on the card in a more convenient manner.</p>

1 Open a Web browser, and then type the printer IP address in the address field.

Note: View the printer IP address on the printer home screen. The IP address appears as four sets of numbers separated by periods, such as 123.123.123.123.

2 Click **Settings > Apps > Apps Management > Card Copy**.

3 Change the default scanning options, if necessary.

- **Default tray**—Select the default tray to be used for printing scan images.
- **Default number of copies**—Specify the number of copies that should automatically print when the application is used.
- **Default contrast setting**—Specify a setting to increase or decrease the level of contrast when a copy of the scanned card is printed. Select **Best for Content** if you want the printer to adjust the contrast automatically.
- **Default scale setting**—Set the size of the scanned card when printed. The default setting is 100% (full size).
- **Resolution setting**—Adjust the quality of the scanned card.

Notes:

- When scanning a card, make sure the scan resolution is not more than 200 dpi for color, and 400 dpi for black and white.
- When scanning multiple cards, make sure the scan resolution is not more than 150 dpi for color, and 300 dpi for black and white.

- **Print Borders**—Select the check box to print the scan image with a border around it.

4 Click **Apply**.

To use the application, touch **Card Copy** on the printer home screen, and then follow the instructions.

Using MyShortcut

Note: A later version of this *User's Guide* may contain a direct link to the *Administrator's Guide* of this application. To check for updates of this *User's Guide*, go to www.dell.com/support/manuals.

Use	To
	<p>Create shortcuts on the printer home screen, with settings for up to 25 frequently used copy, fax, or e-mail jobs.</p>

To use the application, touch **MyShortcut**, and then follow the instructions on the printer display.

Setting up Multi Send

Note: A later version of this *User's Guide* may contain a direct link to the *Administrator's Guide* of this application. To check for updates of this *User's Guide*, go to www.dell.com/support/manuals.

Use	To
	<p>Scan a document, and then send the scanned document to multiple destinations.</p> <p>Note: Make sure there is enough space in the printer hard disk.</p>

1 Open a Web browser, and then type the printer IP address in the address field.

Note: View the printer IP address on the printer home screen. The printer IP address appears as four sets of numbers separated by periods, such as 123.123.123.123.

2 Click **Settings** > **Apps** > **Apps Management** > **Multi Send**.

3 From the Profiles section, click **Add**, and then customize the settings.

Notes:

- See the mouse-over help beside each field for a description of the setting.
- If you select **FTP** or **Share Folder** as a destination, then make sure the location settings of the destination are correct. Type the correct IP address of the host computer where the specified destination is located. For more information on obtaining the IP address of the host computer, see ["Finding the IP address of the computer" on page 20](#).

4 Click **Apply**.

To use the application, touch **Multi Send** on the printer home screen, and then follow the instructions on the printer display.

Setting up Scan to Network

Note: A later version of this *User's Guide* may contain a direct link to the *Administrator's Guide* of this application. To check for updates of this *User's Guide*, go to www.dell.com/support/manuals.

Use	To
	<p>Scan a document and send it to a shared network folder. You can define up to 30 unique folder destinations.</p> <p>Notes:</p> <ul style="list-style-type: none"> • The printer must have permission to write to the destinations. From the computer where the destination is specified, use sharing, security, and firewall settings to allow the printer at least a <i>write</i> access. For help, see the documentation that came with your operating system. • The Scan to Network icon appears only when one or more destinations are defined.

- 1 Open a Web browser, and then type the printer IP address in the address field.

Note: View the printer IP address on the printer home screen. The IP address appears as four sets of numbers separated by periods, such as 123.123.123.123.

- 2 Do either of the following:
 - Click **Set up Scan to Network** > **Click here**.
 - Click **Settings** > **Apps** > **Apps Management** > **Scan to Network**.
- 3 Specify the destinations, and then customize the settings.

Notes:

- See the mouse-over help beside some of the fields for a description of the setting.
- To make sure the location settings of the destination are correct, type the correct IP address of the host computer where the specified destination is located. For more information on obtaining the IP address of the host computer, see [“Finding the IP address of the computer” on page 20](#).
- Make sure the printer has access rights to the folder where the specified destination is located.

- 4 Click **Apply**.

To use the application, touch **Scan to Network** on the printer home screen, and then follow the instructions on the printer display.

Setting up Remote Operator Panel

This application enables you to interact with the printer control panel even when you are not physically near the network printer. From your computer, you can view the printer status, release held print jobs, create bookmarks, and do other print-related tasks.

- 1 Open a Web browser, and then type the printer IP address in the address field.

Note: View the printer IP address on the printer home screen. The IP address appears as four sets of numbers separated by periods, such as 123.123.123.123.

- 2 Click **Settings** > **Remote Operator Panel Settings**.
- 3 Select the **Enable** check box, and then customize the settings.
- 4 Click **Submit**.

To use the application, click **Remote Operator Panel** > **Launch VNC Applet**.

Exporting and importing a configuration

You can export configuration settings into a text file, and then import the file to apply the settings to other printers.

- 1 Open a Web browser, and then type the printer IP address in the address field.

Note: View the printer IP address on the printer home screen. The IP address appears as four sets of numbers separated by periods, such as 123.123.123.123.

- 2 To export or import a configuration for one application, do the following:
 - a Click **Settings** > **Apps** > **Apps Management**.
 - b From the list of installed applications, click the name of the application you want to configure.

c Click **Configure**, and then do either of the following:

- To export a configuration to a file, click **Export**, and then follow the instructions on the computer screen to save the configuration file.

Notes:

- When saving the configuration file, you can type a unique file name or use the default name.
- If a "JVM Out of Memory" error occurs, then repeat the export process until the configuration file is saved.
- To import a configuration from a file, click **Import**, and then browse to the saved configuration file that was exported from a previously configured printer.

Notes:

- Before importing the configuration file, you can choose to preview it first or load it directly.
- If a timeout occurs and a blank screen appears, then refresh the Web browser, and then click **Apply**.

3 To export or import a configuration for multiple applications, do the following:

a Click **Settings > Import/Export**.

b Do either of the following:

- To export a configuration file, click **Export Embedded Solutions Settings File**, and then follow the instructions on the computer screen to save the configuration file.
- To import a configuration file, do the following:
 - 1** Click **Import Embedded Solutions Settings File > Choose File**, and then browse to the saved configuration file that was exported from a previously configured printer.
 - 2** Click **Submit**.

Additional printer setup

Installing internal options

⚠ CAUTION—SHOCK HAZARD: If you are accessing the controller board or installing optional hardware or memory devices sometime after setting up the printer, then turn the printer off, and unplug the power cord from the electrical outlet before continuing. If you have any other devices attached to the printer, then turn them off as well, and unplug any cables going into the printer.

Available internal options

- Memory card
 - DDR3 DIMM
 - Flash memory
 - Fonts
 - Firmware
 - Forms Barcode
 - Prescribe
 - IPDS
 - Printcryption

Accessing the controller board

⚠ CAUTION—SHOCK HAZARD: If you are accessing the controller board or installing optional hardware or memory devices sometime after setting up the printer, then turn the printer off, and unplug the power cord from the electrical outlet before continuing. If you have any other devices attached to the printer, then turn them off as well, and unplug any cables going into the printer.

- 1 Open the controller board access door.



- 2 Open the controller board shield using the blue handle.

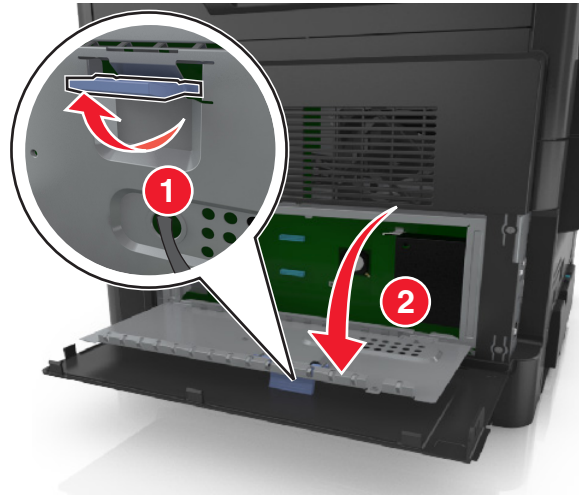

- 3 Use the following illustration to locate the appropriate connector.

Warning—Potential Damage: Controller board electronic components are easily damaged by static electricity. Touch something metal on the printer before touching any controller board electronic components or connectors.

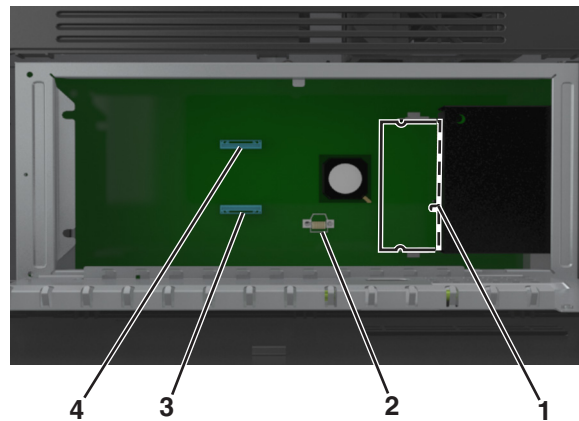

1	Memory card connector
2	Option card connector
3	Printer hard disk connector
4	Internal Solutions Port connector

- 4 Close the shield, and then the access door.



Installing a memory card

CAUTION—SHOCK HAZARD: If you are accessing the controller board or installing optional hardware or memory devices sometime after setting up the printer, then turn the printer off, and unplug the power cord from the electrical outlet before continuing. If you have any other devices attached to the printer, then turn them off as well, and unplug any cables going into the printer.

Warning—Potential Damage: Controller board electronic components are easily damaged by static electricity. Touch something metal on the printer before touching any controller board electronic components or connectors.

Note: An optional memory card can be purchased separately and attached to the controller board.

- 1 Access the controller board.

For more information, see [“Accessing the controller board” on page 27](#).

- 2 Unpack the memory card.

Warning—Potential Damage: Do not touch the connection points along the edge of the card. Doing so may cause damage.

- 3 Align the notch (1) on the memory card with the ridge (2) on the connector.

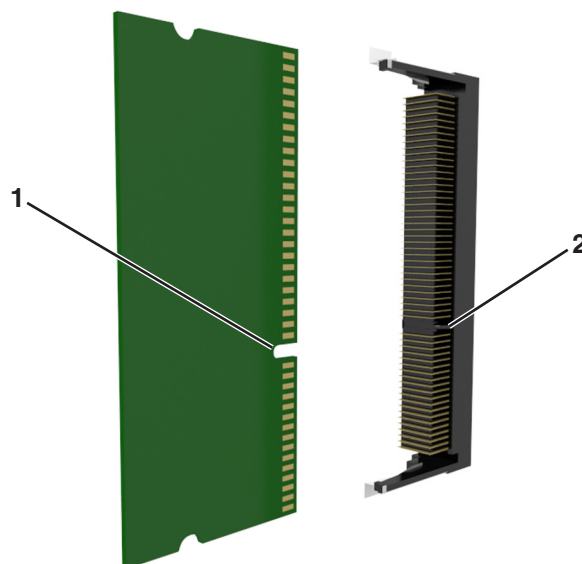

- 4 Push the memory card straight into the connector, and then push the card toward the controller board wall until it *clicks* into place.

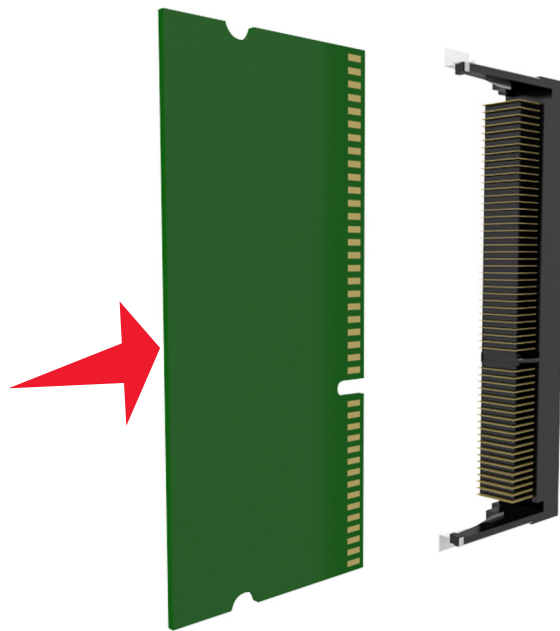

- 5 Close the controller board shield, and then the controller board access door.

Note: When the printer software and any hardware options are installed, you may need to manually add the options in the printer driver to make them available for print jobs. For more information, see [“Adding available options in the print driver” on page 44](#).

Installing an optional card

CAUTION—SHOCK HAZARD: If you are accessing the controller board or installing optional hardware or memory devices sometime after setting up the printer, then turn the printer off, and unplug the power cord from the electrical outlet before continuing. If you have other devices attached to the printer, then turn them off as well, and unplug any cables going into the printer.

Warning—Potential Damage: Controller board electronic components are easily damaged by static electricity. Touch something metal on the printer before touching any controller board electronic components or connectors.

- 1 Access the controller board.
For more information, see [“Accessing the controller board” on page 27](#).
- 2 Unpack the optional card.

Warning—Potential Damage: Avoid touching the connection points along the edge of the card.

3 Holding the card by its sides, align the plastic pins (1) on the card with the holes (2) on the controller board.

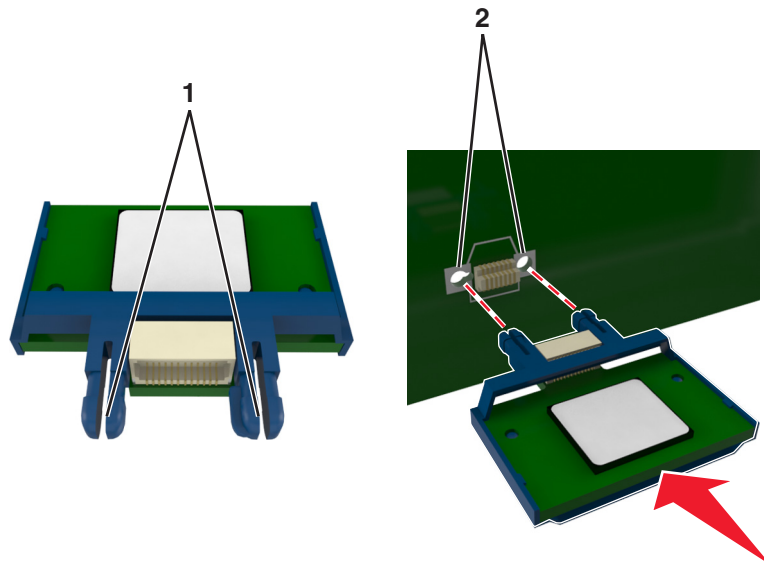

4 Push the card firmly into place as shown in the illustration.

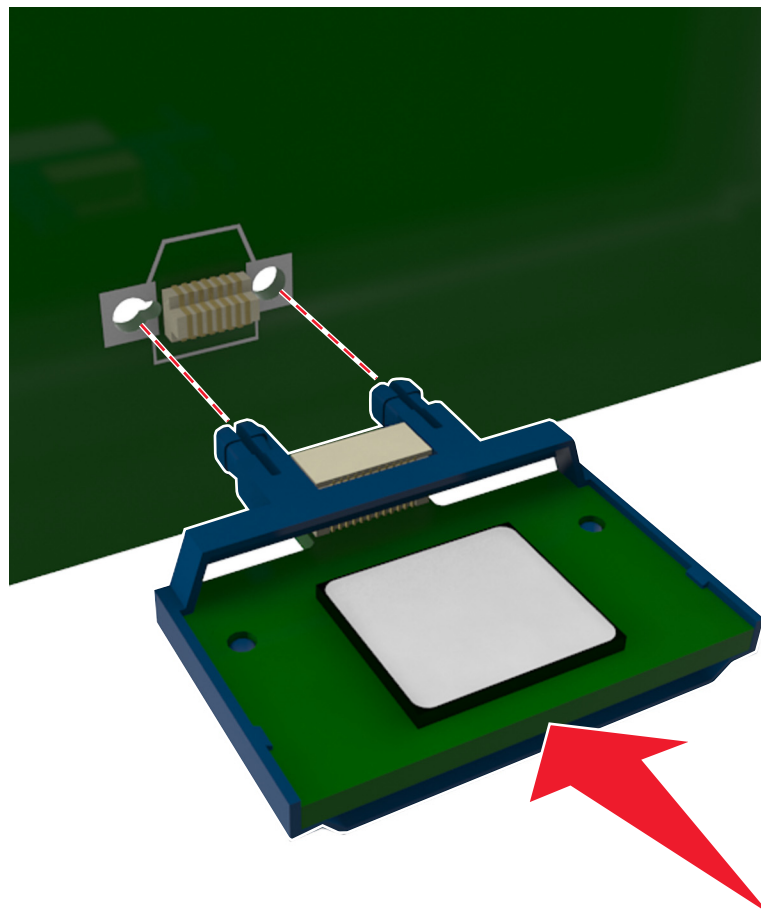

Warning—Potential Damage: Improper installation of the card may cause damage to the card and the controller board.

Note: The entire length of the connector on the card must touch and be flushed against the controller board.

- 5 Close the controller board shield, and then the controller board access door.

Note: When the printer software and any hardware options are installed, it may be necessary to manually add the options in the printer driver to make them available for print jobs. For more information, see [“Adding available options in the print driver” on page 44](#).

Installing an Internal Solutions Port

The controller board supports one optional Internal Solutions Port (ISP).

Note: This task requires a flat-head screwdriver.

CAUTION—SHOCK HAZARD: If you are accessing the controller board or installing optional hardware or memory devices sometime after setting up the printer, then turn the printer off, and unplug the power cord from the electrical outlet before continuing. If you have any other devices attached to the printer, then turn them off as well, and unplug any cables going into the printer.

Warning—Potential Damage: Controller board electronic components are easily damaged by static electricity. Touch a metal surface on the printer before touching any controller board electronic components or connectors.

- 1 Open the controller board access door.

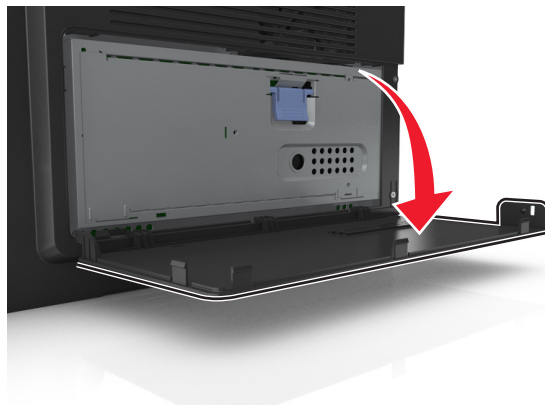

2 Lightly press the stop on the left side of the access door, and then slide the access door to remove it.

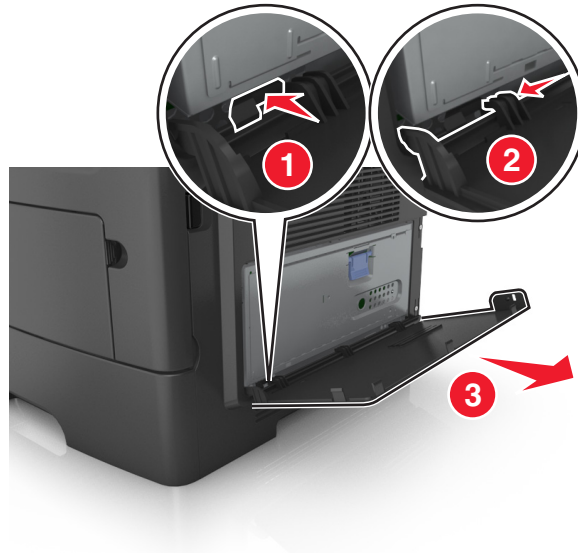

3 Unpack the ISP kit.

Note: Make sure to remove and discard the small cable attached to the white connector.

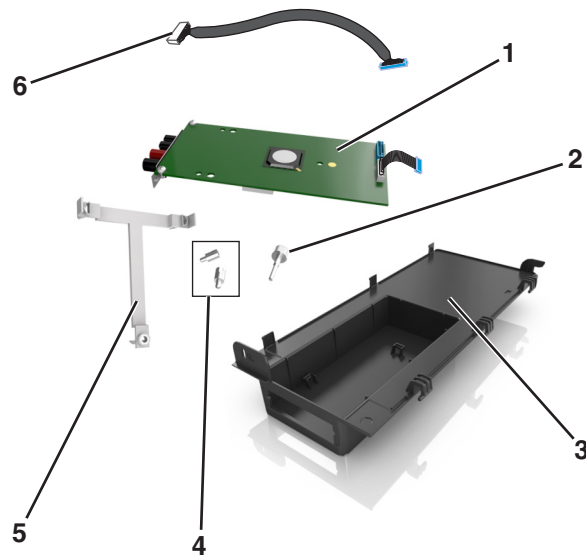

1	ISP solution
2	Screw to attach the ISP to the bracket
3	ISP exterior cover
4	Screws to attach the ISP metal bracket to the printer cage
5	Plastic bracket
6	Long ISP cable

- 4 Place the plastic bracket inside the ISP exterior cover until it *clicks* into place.

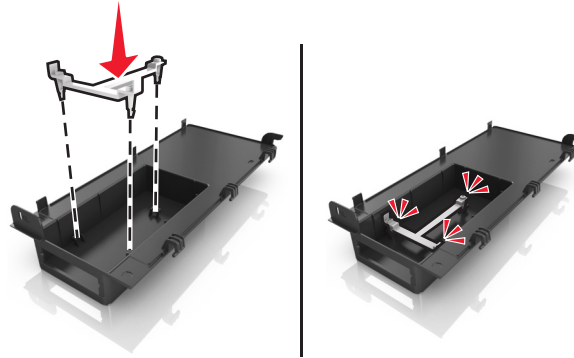

- 5 Slide and push the ISP solution into the plastic bracket.

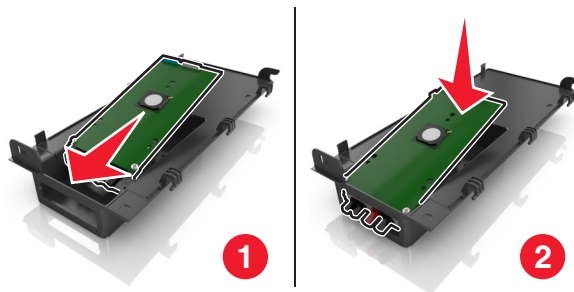

- 6 Secure the ISP solution to the plastic bracket using the long screw.

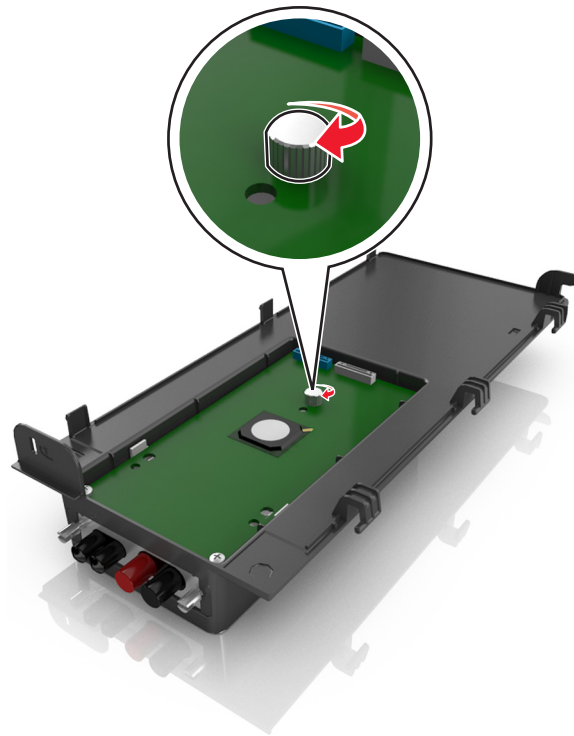

7 Tighten the two screws on the end of the ISP solution.

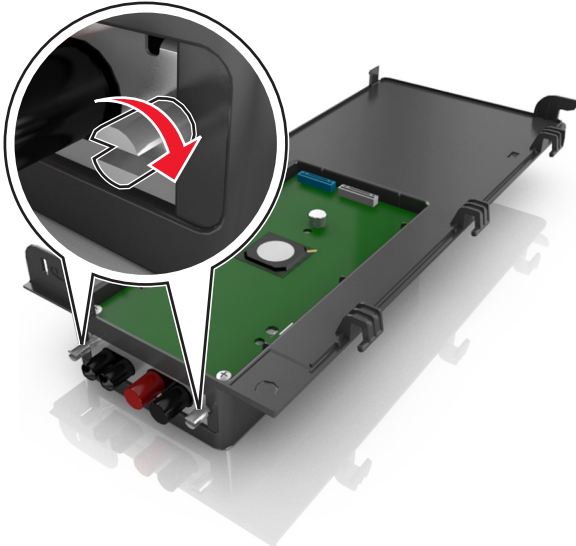

8 Attach the white plug of the ISP solution interface cable into the white receptacle on the ISP.

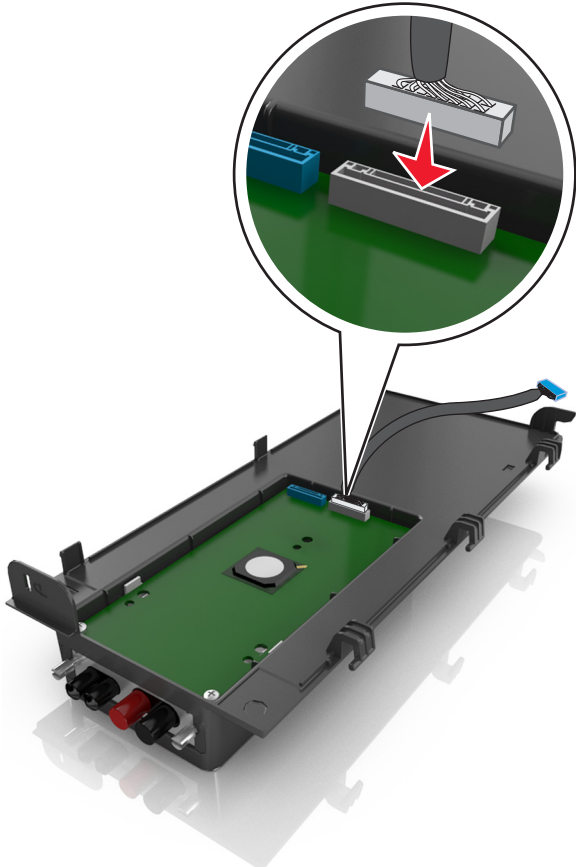

9 Attach the ISP exterior cover at an angle by inserting the left hinges first.



10 Lower the rest of the cover, and then slide the cover to the right.

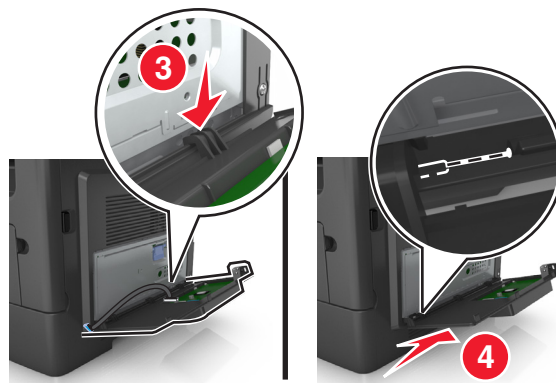

- 11** Run the ISP cable through the controller board shield.

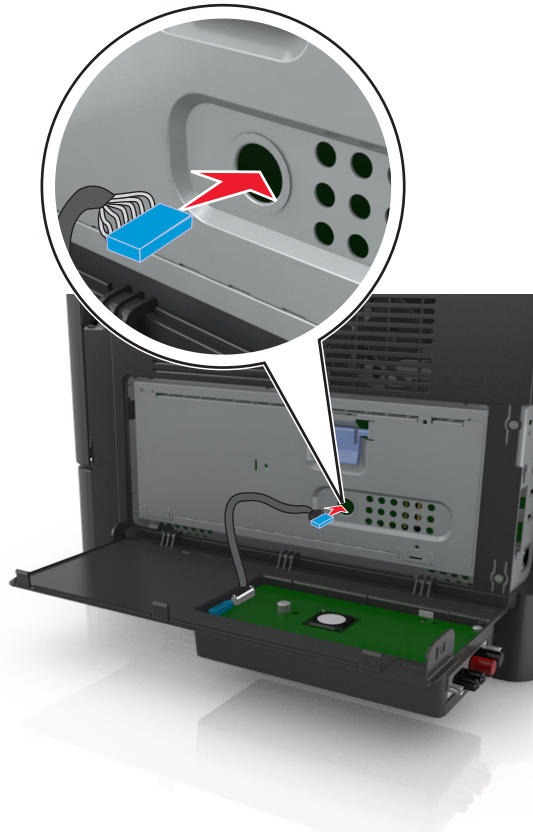

- 12** Open the shield using the blue handle.

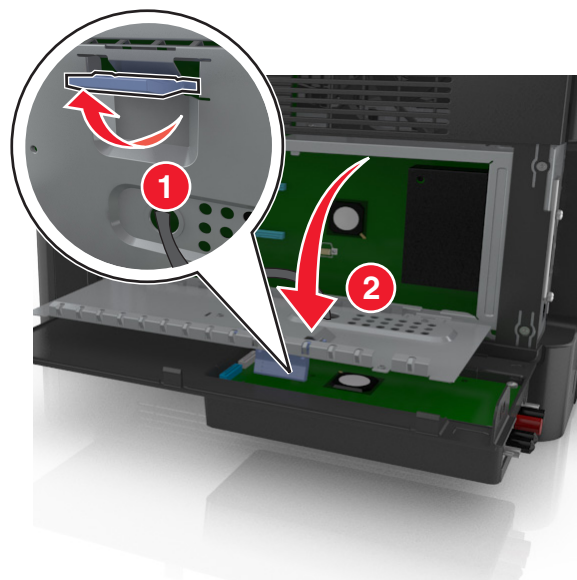

- 13** Attach the blue plug of the ISP solution interface cable into the blue receptacle on the controller board.

Note: If you have installed a printer hard disk, then you need to remove it. For more information, see [“Removing a printer hard disk” on page 41](#). To reinstall the printer hard disk, see [“Installing a printer hard disk” on page 39](#).

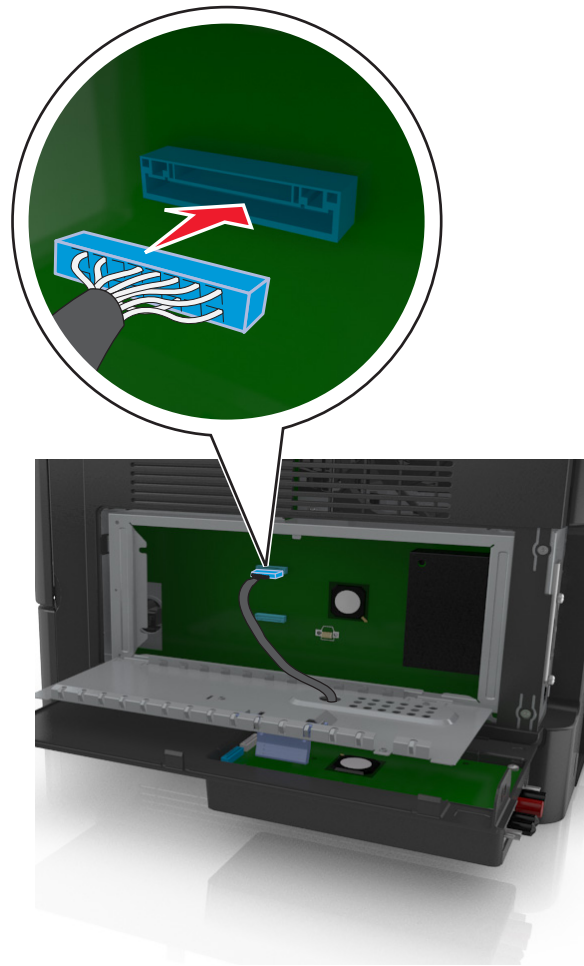

14 Close the shield.

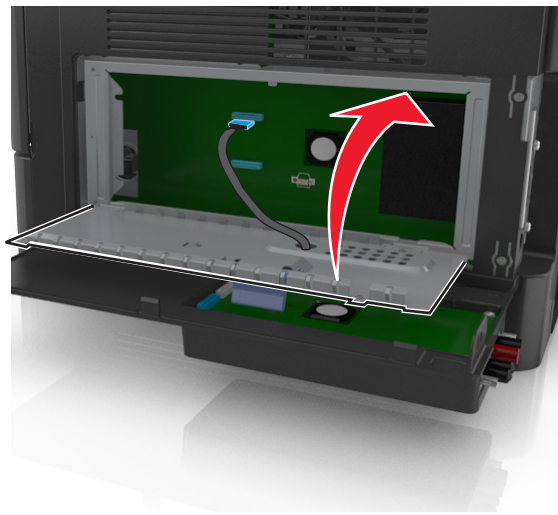

15 Close the ISP exterior cover.

Note: When the printer software and any hardware options are installed, it may be necessary to manually add the options in the printer driver to make them available for print jobs. For more information, see [“Adding available options in the print driver” on page 44.](#)

Installing a printer hard disk

⚠ CAUTION—SHOCK HAZARD: If you are accessing the controller board or installing optional hardware or memory devices sometime after setting up the printer, then turn the printer off, and unplug the power cord from the electrical outlet before continuing. If you have any other devices attached to the printer, then turn them off as well, and unplug any cables going into the printer.

Warning—Potential Damage: Controller board electronic components are easily damaged by static electricity. Touch a metal surface on the printer before touching any controller board electronic components or connectors.

- 1 Unpack the printer hard disk.
- 2 Install the printer hard disk on the controller board.

Warning—Potential Damage: Hold only the edges of the printed circuit board assembly. Do not touch or press on the center of the printer hard disk. Doing so may cause damage.

- a Using a flat-head screwdriver, loosen the screws.

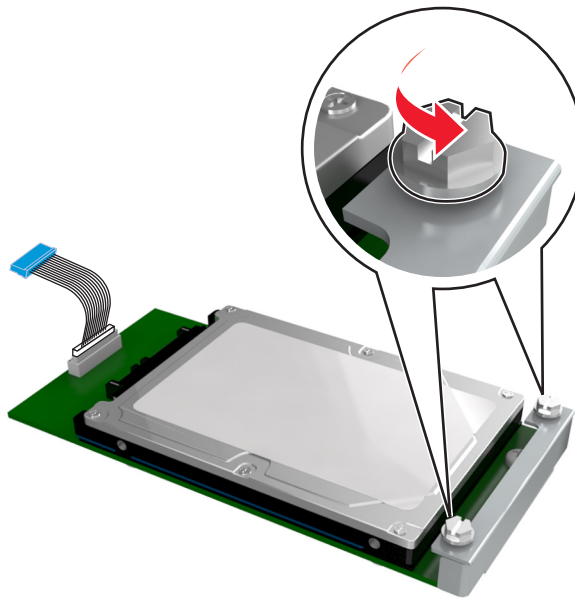

- b Insert the plug of the printer hard disk interface cable into the receptacle of the controller board.

Note: The plug and the receptacle are color-coded blue.

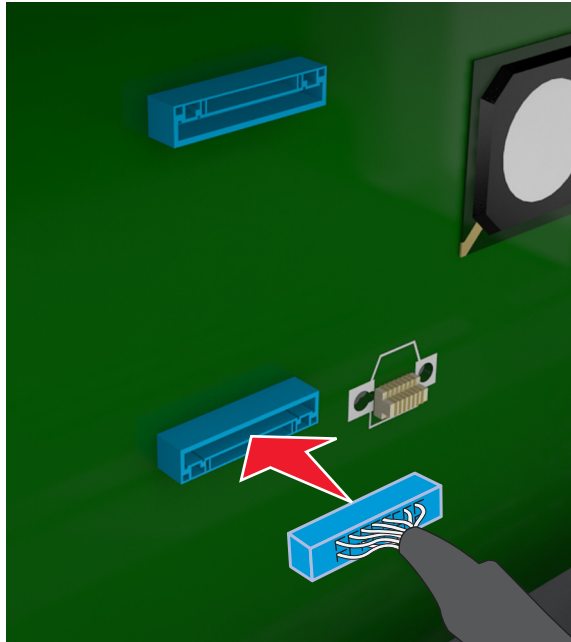

- c Align the screws on the printer hard disk to the slots on the controller board bracket, and then slide the printer hard disk onto the brackets.

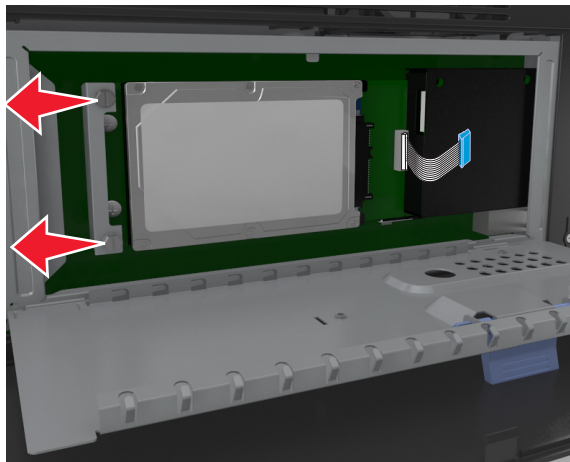

- d Tighten the two screws.

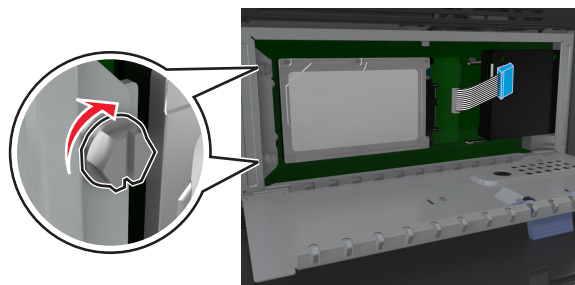

- 3 Close the controller board shield, and then close the controller board access door.

Note: When the printer software and any hardware options are installed, you may need to manually add the options in the printer driver to make them available for print jobs. For more information, see [“Adding available options in the print driver” on page 44](#).

Removing a printer hard disk

Warning—Potential Damage: Controller board electronic components are easily damaged by static electricity. Touch a metal surface on the printer before touching any controller board electronic components or connectors.

- 1 Access the controller board.

For more information, see [“Accessing the controller board” on page 27](#).

Note: This task requires a flat-head screwdriver.

- 2 Loosen the screws that connect the printer hard disk to the controller board bracket.

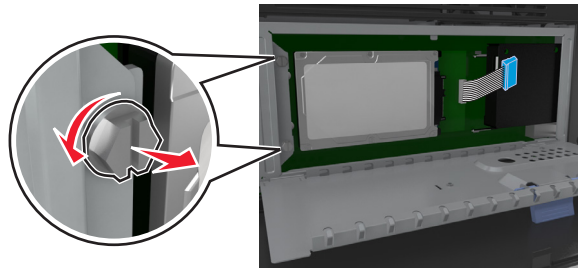

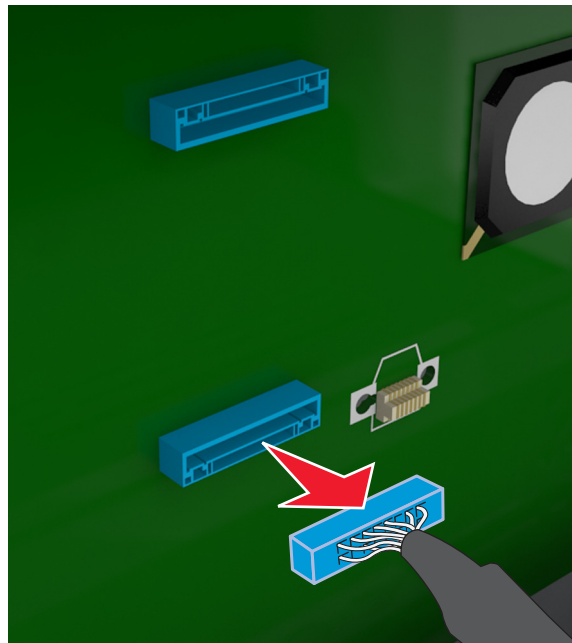

- 3 Unplug the printer hard disk interface cable from the receptacle in the controller board, leaving the cable attached to the printer hard disk. To unplug the cable, squeeze the paddle at the plug of the interface cable to disengage the latch before pulling the cable out.



- 4 Hold the printer hard disk by the edges, and then remove it from the printer.
- 5 Close the controller board shield, and then close the access door.

Installing hardware options

Order of installation



-  **CAUTION—POTENTIAL INJURY:** The printer weight is greater than 18 kg (40 lb) and requires two or more trained personnel to lift it safely.
-  **CAUTION—SHOCK HAZARD:** If you are accessing the controller board or installing optional hardware or memory devices sometime after setting up the printer, then turn the printer off, and unplug the power cord from the electrical outlet before continuing. If you have any other devices attached to the printer, then turn them off as well, and unplug any cables going into the printer.
-  **CAUTION—TIPPING HAZARD:** Floor-mounted configurations require additional furniture for stability. You must use either a printer stand or printer base if you are using multiple input options. If you purchased a multifunction printer (MFP) that scans, copies, and faxes, then you may need additional furniture. For more information, contact the place where you purchased the printer.

Install the printer and any hardware options you have purchased in the following order:

- Printer stand
- Optional 550-sheet tray
- Printer

For more information on installing a printer stand, optional 550-sheet tray, or spacer, see the setup sheet that came with the option.

Installing optional trays

-  **CAUTION—POTENTIAL INJURY:** The printer weight is greater than 18 kg (40 lb) and requires two or more trained personnel to lift it safely.
-  **CAUTION—SHOCK HAZARD:** If you are accessing the controller board or installing optional hardware or memory devices sometime after setting up the printer, then turn the printer off, and unplug the power cord from the electrical outlet before continuing. If you have any other devices attached to the printer, then turn them off as well, and unplug any cables going into the printer.
-  **CAUTION—TIPPING HAZARD:** Floor-mounted configurations require additional furniture for stability. You must use either a printer stand or printer base if you are using multiple input options. If you purchased a multifunction printer (MFP) that scans, copies, and faxes, you may need additional furniture. For more information, contact the place where you purchased the printer.

- 1 Turn off the printer using the power switch, and then unplug the power cord from the electrical outlet.

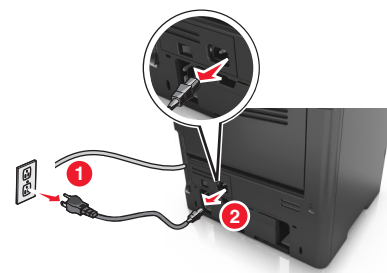
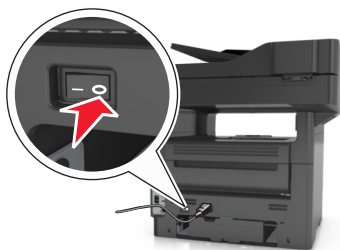

- 2 Unpack the tray, and then remove all packing material.
- 3 Pull out the tray from the base.

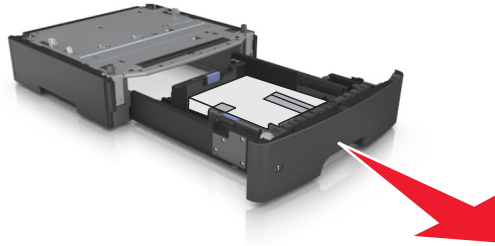

- 4 Remove any packing material from inside the tray.
- 5 Insert the tray into the base.
- 6 Place the tray near the printer.
- 7 Align the printer with the tray, and then slowly lower the printer into place.

Note: Optional trays lock together when stacked.

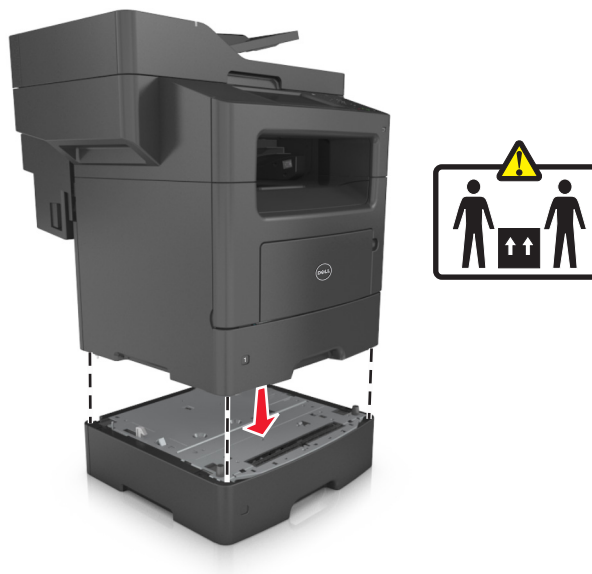

- 8 Connect the power cord to the printer, then to a properly grounded electrical outlet, and then turn on the printer.

**Notes:**

- When the printer software and any hardware options are installed, you may need to manually add the options in the printer driver to make them available for print jobs. For more information, see [“Adding available options in the print driver” on page 44](#).
- To uninstall the optional trays, slide the latch on the right side of the printer toward the front of the printer until it *clicks* into place, and then remove stacked trays one at a time from the top to the bottom.

Setting up the printer software

Installing the printer

- 1 Obtain a copy of the software installer package.
- 2 Run the installer, and then follow the instructions on the computer screen.
- 3 For Macintosh users, add the printer.

Note: Obtain the printer IP address from the TCP/IP section in the Network/Ports menu.

Adding available options in the print driver

For Windows users

- 1 Open the printers folder, and then select your printer.
- 2 Open the printer properties, and then add or manually install any options.
- 3 Apply the changes.

For Macintosh users

- 1 From System Preferences in the Apple menu, navigate to your printer, and then select **Options & Supplies > Driver**.
- 2 Add any installed hardware options.
- 3 Apply the changes.

Attaching cables

⚠ CAUTION—POTENTIAL INJURY: Do not use the fax feature during a lightning storm. Do not set up this product or make any electrical or cabling connections, such as the fax feature, power cord, or telephone, during a lightning storm.

Connect the printer to the computer using a USB cable or to the network using an Ethernet cable.

Make sure to match the following:

- The USB symbol on the cable with the USB symbol on the printer
- The appropriate Ethernet cable with the Ethernet port

Warning—Potential Damage: Do not touch the USB cable, any network adapter, or the printer in the area shown while actively printing or scanning. Loss of data or a malfunction can occur.

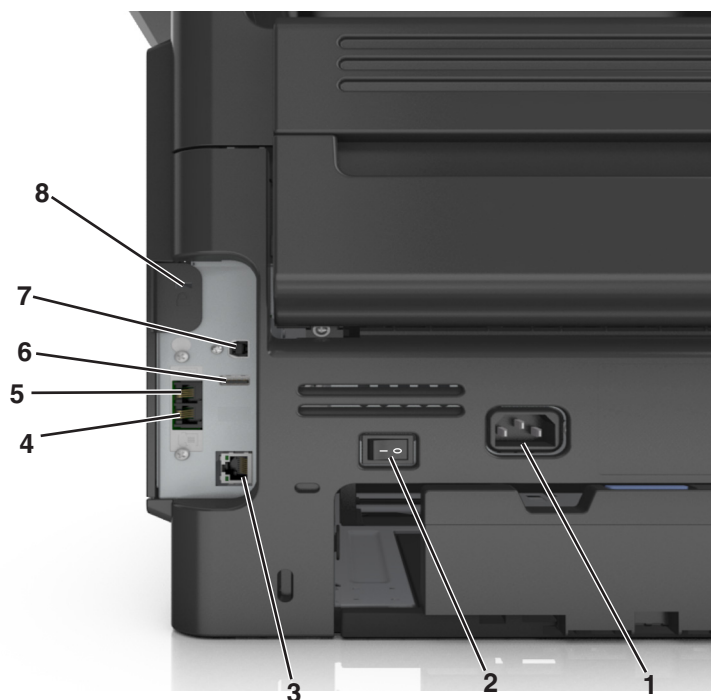

	Use the	To
1	Printer power cord socket	Connect the printer to a properly grounded electrical outlet.
2	Power switch	Turn the printer on or off.
3	Ethernet port	Connect the printer to an Ethernet network.
4	EXT port	Connect additional devices (telephone or answering machine) to the printer and the telephone line. Use this port if you do not have a dedicated fax line for the printer and if this connection method is supported in your country or region. Note: Remove the adapter plug to access the port.
5	LINE port	Connect the printer to an active telephone line through a standard wall jack (RJ-11), DSL filter, or VoIP adapter, or any other adapter that allows you to access the telephone line to send and receive faxes.
6	USB port	Attach a supported printer keyboard.

	Use the	To
7	USB printer port	Connect the printer to a computer.
8	Security slot	Attach a lock that will secure the printer in place.

Networking

Notes:

- Purchase a wireless network adapter first before setting up the printer on a wireless network. For more information, contact the place where you purchased the printer.
- A Service Set Identifier (SSID) is a name assigned to a wireless network. Wired Equivalent Privacy (WEP), Wi-Fi Protected Access (WPA), WPA2, and 802.1X-RADIUS are types of security used on a network.

Preparing to set up the printer on an Ethernet network

To configure your printer to connect to an Ethernet network, organize the following information before you begin:

Note: If your network automatically assigns IP addresses to computers and printers, continue on to installing the printer.

- A valid, unique IP address for the printer to use on the network
- The network gateway
- The network mask
- A nickname for the printer (optional)

Note: A printer nickname can make it easier for you to identify your printer on the network. You can choose to use the default printer nickname, or assign a name that is easier for you to remember.

You will need an Ethernet cable to connect the printer to the network and an available port where the printer can physically connect to the network. Use a new network cable when possible to avoid potential problems caused by a damaged cable.

Preparing to set up the printer on a wireless network

Notes:

- Make sure your wireless network adapter is installed in your printer and working properly. For more information, see the instruction sheet that came with the wireless network adapter.
- Make sure your access point (wireless router) is turned on and is working properly.

Make sure you have the following information before setting up the printer on a wireless network:

- **SSID**—The SSID is also referred to as the network name.
- **Wireless Mode (or Network Mode)**—The mode is either infrastructure or ad hoc.
- **Channel (for ad hoc networks)**—The channel defaults to automatic for infrastructure networks.

Some ad hoc networks will also require the automatic setting. Check with your system support person if you are not sure which channel to select.

- **Security Method**—There are four basic options for Security Method:
 - WEP key
If your network uses more than one WEP key, then enter up to four in the provided spaces. Select the key currently in use on the network by selecting the default WEP transmit key.
 - WPA or WPA2 preshared key or passphrase
WPA includes encryption as an additional layer of security. The choices are AES or TKIP. Encryption must be set for the same type on the router and on the printer, or the printer will not be able to communicate on the network.
 - 802.1X–RADIUS
If you are installing the printer on an 802.1X network, then you may need the following:
 - Authentication type
 - Inner authentication type
 - 802.1X user name and password
 - Certificates
 - No security
If your wireless network does not use any type of security, then you will not have any security information.
Note: We do not recommend using an unsecured wireless network.

Notes:

- If you do not know the SSID of the network that your computer is connected to, then launch the wireless utility of the computer network adapter, and then look for the network name. If you cannot find the SSID or the security information for your network, then see the documentation that came with the access point, or contact your system support person.
- To find the WPA/WPA2 preshared key or passphrase for the wireless network, see the documentation that came with the access point, see the Embedded Web Server associated with the access point, or consult your system support person.

Connecting the printer using the Wireless Setup Wizard

Before you begin, make sure that:

- A wireless network adapter is installed in the printer and is working properly. For more information, see the instruction sheet that came with the wireless network adapter.
- An Ethernet cable is disconnected from the printer.
- Active NIC is set to Auto. To set this to Auto, navigate to:



> **Network/Ports > Active NIC > Auto > Submit**

Note: Make sure to turn off the printer, then wait for at least five seconds, and then turn the printer back on.

- 1 From the printer control panel, navigate to:



> **Network/Ports > Network [x] > Network [x] Setup > Wireless > Wireless Connection Setup**

- 2 Select a wireless connection setup.

Use	To
Search for networks	Show available wireless connections. Note: This menu item shows all broadcast secured or unsecured SSIDs.
Enter a network name	Manually type the SSID. Note: Make sure to type the correct SSID.
Wi-Fi Protected Setup	Connect the printer to a wireless network using Wi-Fi Protected Setup.

- 3 Follow the instructions on the printer display.

Connecting the printer to a wireless network using Wi-Fi Protected Setup

Before you begin, make sure that:

- The access point (wireless router) is Wi-Fi Protected Setup (WPS) certified or WPS-compatible. For more information, see the documentation that came with your access point.
- A wireless network adapter installed in your printer is attached and working properly. For more information, see the instruction sheet that came with the wireless network adapter.

Using the Push Button Configuration method

- 1 From the printer control panel, navigate to:



> **Network/Ports** > **Network [x]** > **Network [x] Setup** > **Wireless** > **Wireless Connection Setup** > **Wi-Fi Protected Setup** > **Start Push Button Method**

- 2 Follow the instructions on the printer display.

Using the Personal Identification Number (PIN) method

- 1 From the printer control panel, navigate to:



> **Network/Ports** > **Network [x]** > **Network [x] Setup** > **Wireless** > **Wireless Connection Setup** > **Wi-Fi Protected Setup** > **Start PIN Method**

- 2 Copy the eight-digit WPS PIN.
- 3 Open a Web browser, and then type the IP address of your access point in the address field.

Notes:

- The IP address appears as four sets of numbers separated by periods, such as 123.123.123.123.
- If you are using a proxy server, then temporarily disable it to load the Web page correctly.

- 4 Access the WPS settings. For more information, see the documentation that came with your access point.
- 5 Enter the eight-digit PIN, and then save the setting.

Connecting the printer to a wireless network using the Embedded Web Server

Before you begin, make sure that:

- Your printer is connected temporarily to an Ethernet network.
- A wireless network adapter is installed in your printer and working properly. For more information, see the instruction sheet that came with the wireless network adapter.

1 Open a Web browser, and then type the printer IP address in the address field.

Notes:

- View the printer IP address on the printer control panel. The IP address appears as four sets of numbers separated by periods, such as 123.123.123.123.
- If you are using a proxy server, then temporarily disable it to load the Web page correctly.

2 Click **Settings > Network/Ports > Wireless**.

3 Modify the settings to match the settings of your access point (wireless router).

Note: Make sure to enter the correct SSID, security method, preshared key or passphrase, network mode, and channel.

4 Click **Submit**.

5 Turn off the printer, and then disconnect the Ethernet cable. Then wait for at least five seconds, and then turn the printer back on.

6 To verify if your printer is connected to the network, print a network setup page. Then in the Network Card [x] section, see if the status is Connected.

Changing port settings after installing a new network ISP

Notes:

- If the printer has a static IP address, then you do not need to make any changes.
- If the computers are configured to use the network name, instead of an IP address, then you do not need to make any changes.
- If you are adding a wireless ISP to a printer previously configured for an Ethernet connection, then make sure the printer is disconnected from the Ethernet network.

For Windows users

1 Open the printers folder.

2 From the shortcut menu of the printer with the new ISP, open the printer properties.

3 Configure the port from the list.

4 Update the IP address.

5 Apply the changes.

For Macintosh users

1 From System Preferences in the Apple menu, navigate to the list of printers, and then select **+ > IP**.

2 Type the IP address in the address field.

- 3 Apply the changes.

Setting up serial printing

Use serial printing when the computer is far from the printer. After installing the serial or communication (COM) port, configure the printer and the computer.

Note: Serial printing reduces print speed.

- 1 Set the parameters in the printer.
 - a From the control panel, navigate to the menu for the port settings.
 - b Locate the menu for the serial port settings, and then adjust the settings, if necessary.
 - c Save the settings.
- 2 From your computer, open the printers folder, and then select your printer.
- 3 Open the printer properties, and then select the COM port from the list.
- 4 Set the COM port parameters in Device Manager.

Use the Run dialog box to open the command prompt, and then type `devmgmt.msc`.

Verifying printer setup

When all hardware and software options are installed and the printer is turned on, verify that the printer is set up correctly by printing the following:

- **Menu settings page**—Use this page to verify that all printer options are installed correctly. A list of installed options appears toward the bottom of the page. If an option you installed is not listed, then it is not installed correctly. Remove the option, and then install it again.
- **Network setup page**—If your printer has Ethernet or wireless capability and is attached to a network, then print a network setup page to verify the network connection. This page also provides important information that aids network printing configuration.

Printing a menu settings page

From the home screen, navigate to:



> Reports > Menu Settings Page

Printing a network setup page

If the printer is attached to a network, then print a network setup page to verify the network connection. This page also provides important information that aids network printing configuration.

- 1 From the home screen, navigate to:



> Reports > Network Setup Page

- 2 Check the first section of the network setup page, and confirm that the status is **Connected**.

If the status is **Not Connected**, then the LAN drop may not be active, or the network cable may be malfunctioning. Consult a system support person for a solution, and then print another network setup page.

Loading paper and specialty media

The selection and handling of paper and specialty media can affect how reliably documents print. For more information, see [“Avoiding jams” on page 224](#) and [“Storing paper” on page 69](#).

Setting the paper size and type

From the home screen, navigate to:



> **Paper Menu** > **Paper Size/Type** > select a tray > select the paper size or type > **Submit**

Notes:

- The Paper Size setting is automatically set according to the position of the paper guides in each tray except the standard 550-sheet tray (Tray 1) and the multipurpose feeder.
- The Paper Size setting for Tray 1 and the multipurpose feeder must be set manually in the Paper Size menu.
- The factory default Paper Type setting is Plain Paper.
- The Paper Type setting must be set manually for all trays.

Configuring Universal paper settings

The Universal paper size is a user-defined setting that lets you print on paper sizes that are not preset in the printer menus.

Notes:

- The smallest supported Universal size is 76.2 x 76.2 mm (3 x 3 inches).
- The largest supported Universal size is 215.9 x 359.92 mm (8.5 x 14.17 inches).

1 From the home screen, navigate to:



> **Paper Menu** > **Universal Setup** > **Units of Measure** > select the unit of measure >

2 Touch **Portrait Width** or **Portrait Height**.

3 Select the width or height, and then touch .

Loading trays



CAUTION—POTENTIAL INJURY: To reduce the risk of equipment instability, load each tray separately. Keep all other trays closed until needed.

1 Pull out the tray completely.

Note: Do not remove trays while a job prints or while **Busy** appears on the printer display. Doing so may cause a jam.



2 Squeeze, and then slide the width guide tab to the correct position for the size of the paper you are loading.

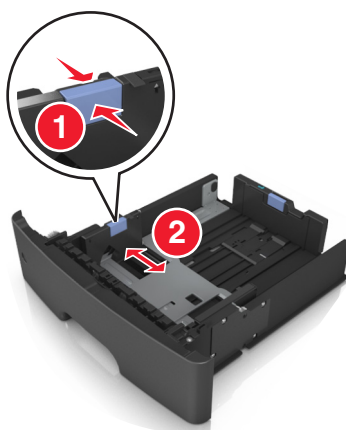

- 3 Squeeze, and then slide the length guide tab to the correct position for the size of the paper you are loading.

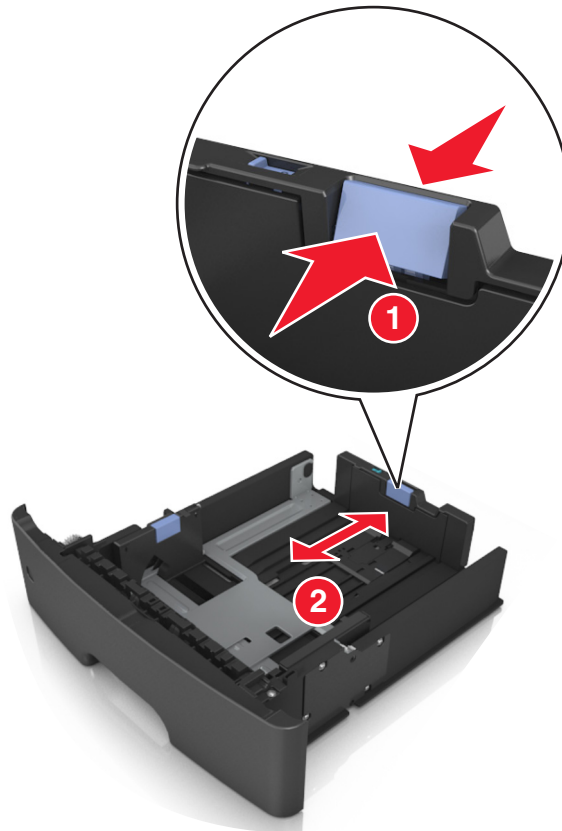
**Notes:**

- For some paper sizes like letter, legal, and A4, squeeze, and then slide the length guide tab backward to accommodate their length.
- If you are loading A6-size paper in the standard tray, squeeze, and then slide the length guide tab toward the center of the tray to the A6-size position.
- Make sure the width and length guides are aligned with the paper size indicators on the bottom of the tray.

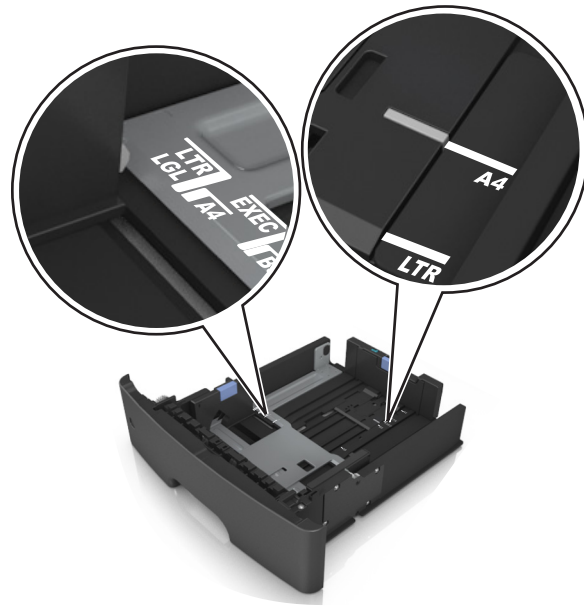

- 4** Flex the sheets back and forth to loosen them, and then fan them. Do not fold or crease the paper. Straighten the edges on a level surface.

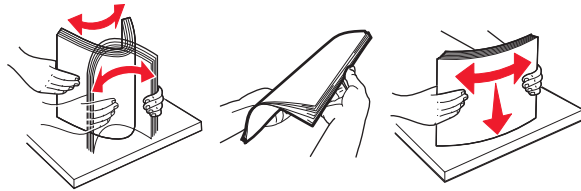

- 5** Load the paper stack with the printable side facedown.

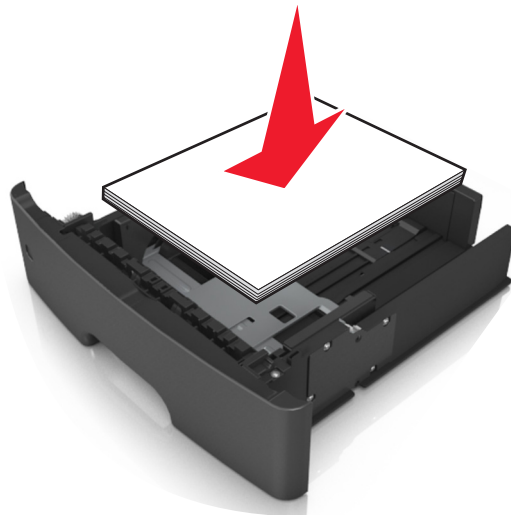

- There are different ways of loading letterhead depending on whether an optional staple finisher is installed or not, and whether two sided printing is needed.

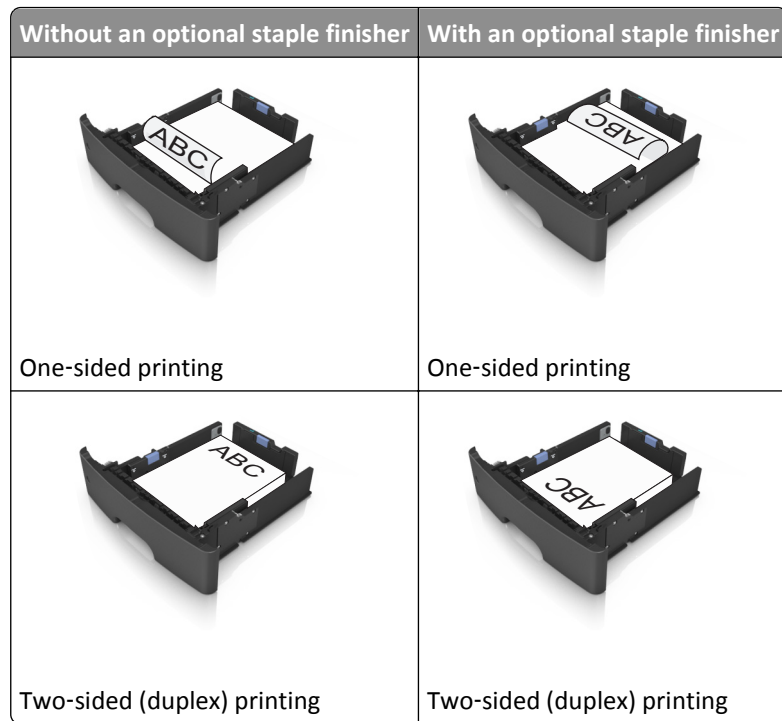

- Make sure the paper is below the maximum paper fill indicator located on the side of the width guide. Overfilling may cause paper jams.



- 6 Insert the tray.



- 7 From the printer control panel, set the paper size and paper type in the Paper menu to match the paper loaded in the tray.

Note: Set the correct paper size and paper type to avoid paper jams and print quality problems.

Loading the multipurpose feeder

Use the multipurpose feeder when printing on different paper sizes and types or specialty media, such as card stock, transparencies, and envelopes. You can also use it for single-page print jobs on letterhead.

- 1 Open the multipurpose feeder.



- a** Pull the multipurpose feeder extender.



- b** Pull the extender gently so that the multipurpose feeder is fully extended and open.



- 2 Squeeze the tab on the left width guide, and then move the guides for the paper you are loading.

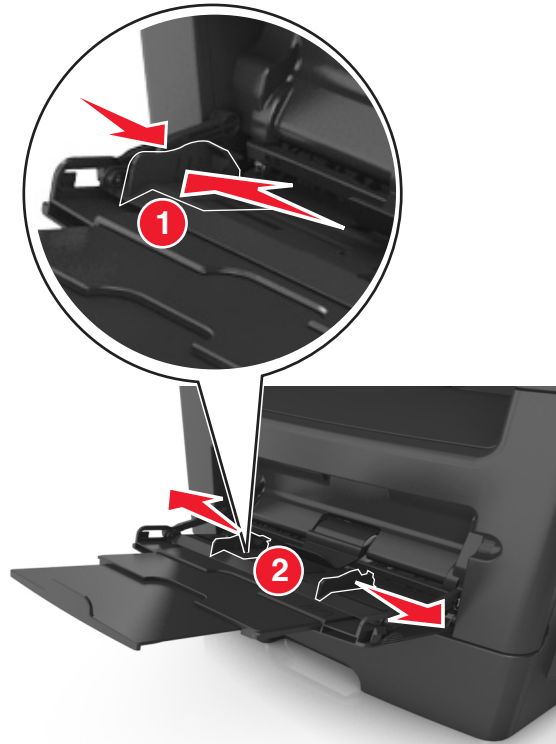

- 3 Prepare the paper or specialty media for loading.

- Flex sheets of paper back and forth to loosen them, and then fan them. Do not fold or crease the paper. Straighten the edges on a level surface.

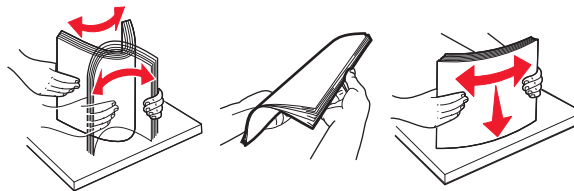

- Hold transparencies by the edges. Flex the stack of transparencies back and forth to loosen them, and then fan them. Straighten the edges on a level surface.

Note: Avoid touching the printable side of the transparencies. Be careful not to scratch them.

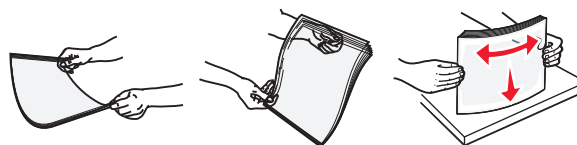

- Flex the stack of envelopes back and forth to loosen them, and then fan them. Straighten the edges on a level surface.



4 Load the paper or specialty media.

Notes:

- Do not force paper or specialty media into the multipurpose feeder.
- Make sure the paper or specialty media is below the maximum paper fill indicator located on the paper guides. Overfilling may cause paper jams.



- Load paper, transparencies, and card stock with the recommended printable side faceup and the top edge entering the printer first. For more information on loading transparencies, see the packaging that the transparencies came in.



Note: When loading A6-size paper, make sure the multipurpose feeder extender rests lightly against the edge of the paper so that the last few sheets of paper remain in place.



- Load letterhead faceup with the top edge entering the printer first. For two-sided (duplex) printing, load letterhead facedown with the bottom edge entering the printer first.



- Load envelopes with the flap on the left side facedown.



Warning—Potential Damage: Never use envelopes with stamps, clasps, snaps, windows, coated linings, or self-stick adhesives. These envelopes may severely damage the printer.

- 5 From the printer control panel, set the paper size and paper type in the Paper menu to match the paper or specialty media loaded in the multipurpose feeder.

Using the standard bin and paper stop

The standard bin holds up to 150 sheets of 20-lb paper. It collects prints facedown. The standard bin includes a paper stop that keeps paper from sliding out the front of the bin as it stacks.

To open the paper stop, pull it so that it flips forward.



Note: Close the paper stop when moving the printer to another location.

Linking and unlinking trays

When the paper size and paper type for any trays are the same, the printer links those trays. When one linked tray becomes empty, paper feeds from the next linked tray. We recommend giving all unique paper, such as letterhead and different colored plain papers, a different custom type name so that the trays they are in do not automatically link.

Linking and unlinking trays

- 1 Open a Web browser, and then type the printer IP address in the address field.

Notes:

- View the printer IP address on the printer home screen. The IP address appears as four sets of numbers separated by periods, such as 123.123.123.123.
- If you are using a proxy server, then temporarily disable it to load the Web page correctly.

- 2 Click **Settings > Paper Menu**.

- 3 Change the paper size and type settings for the trays you are linking.

- To link trays, make sure the paper size and type for the tray match that of the other tray.
- To unlink trays, make sure the paper size or type for the tray does *not* match that of the other tray.

- 4 Click **Submit**.

Note: You can also change the paper size and type settings using the printer control panel. For more information, see [“Setting the paper size and type” on page 51](#).

Warning—Potential Damage: Paper loaded in the tray should match the paper type name assigned in the printer. The temperature of the fuser varies according to the specified paper type. Printing issues may occur if settings are not properly configured.

Creating a custom name for a paper type

Using the Embedded Web Server

- 1 Open a Web browser, and then type the printer IP address in the address field.

Notes:

- View the printer IP address on the printer home screen. The IP address appears as four sets of numbers separated by periods, such as 123.123.123.123.
- If you are using a proxy server, then temporarily disable it to load the Web page correctly.

- 2 Click **Settings > Paper Menu > Custom Names**.

- 3 Select a custom name, and then type a custom paper type name.

- 4 Click **Submit**.

- 5 Click **Custom Types**, and then verify if the new custom paper type name has replaced the custom name.

Using the printer control panel

- 1 From the home screen, navigate to:



> **Paper Menu** > **Custom Names**

- 2 Select a custom name, and then type a custom paper type name.
- 3 Touch .
- 4 Touch **Custom Types**, and then verify that the new custom paper type name has replaced the custom name.

Assigning a custom paper type

Using the Embedded Web Server

Assign a custom paper type name to a tray when linking or unlinking trays.

- 1 Open a Web browser, and then type the printer IP address in the address field.

Notes:

- View the printer IP address on the printer home screen. The IP address appears as four sets of numbers separated by periods, such as 123.123.123.123.
- If you are using a proxy server, then temporarily disable it to load the Web page correctly.

- 2 Click **Settings** > **Paper Menu** > **Custom Types**.
- 3 Select a custom paper type name, and then select a paper type
Note: Paper is the factory default paper type for all user-defined custom names.
- 4 Click **Submit**.

Using the printer control panel

- 1 From the home screen, navigate to:



> **Paper Menu** > **Custom Types**

- 2 Select a custom paper type name, and then select a paper type
Note: Paper is the factory default paper type for all user-defined custom names.
- 3 Touch .

Configuring a custom name

Using the Embedded Web Server

- 1 Open a Web browser, and then type the printer IP address in the address field.

Notes:

- View the printer IP address on the printer home screen. The IP address appears as four sets of numbers separated by periods, such as 123.123.123.123.

- If you are using a proxy server, then temporarily disable it to load the Web page correctly.

2 Click **Settings > Paper Menu > Custom Types**.

3 Select a custom name you want to configure, then select a paper or specialty media type, and then click **Submit**.

Using the printer control panel

1 From the home screen, navigate to:



> **Paper Menu > Custom Types**

2 Select a custom name you want to configure, and then touch .

Paper and specialty media guide

Using specialty media

Tips on using letterhead

- Use letterhead designed specifically for laser printers.
- Print samples on the letterhead being considered for use before buying large quantities.
- Before loading letterhead, flex, fan, and straighten the stack to prevent sheets from sticking together.
- Page orientation is important when printing on letterhead. For information on how to load letterhead, see:
 - [“Loading trays” on page 51](#)
 - [“Loading the multipurpose feeder” on page 56](#)

Tips on using transparencies

- Print a test page on the transparencies being considered for use before buying large quantities.
- Feed transparencies from the standard tray, or the multipurpose feeder.
- Use transparencies designed specifically for laser printers. Transparencies must be able to withstand temperatures up to 185°C (365°F) without melting, discoloring, offsetting, or releasing hazardous emissions.
Note: If the transparency weight is set to Heavy and the transparency texture is set to Rough in the Paper menu, then transparencies can be printed at a temperature up to 195°C (383°F).
- Avoid getting fingerprints on the transparencies to prevent print quality problems.
- Before loading transparencies, flex, fan, and straighten the stack to prevent sheets from sticking together.

Tips on using envelopes

Print samples on the envelopes being considered for use before buying large quantities.

- Use envelopes designed specifically for laser printers. Check with the manufacturer or vendor to ensure that the envelopes can withstand temperatures up to 230°C (446°F) without sealing, wrinkling, curling excessively, or releasing hazardous emissions.
- For best performance, use envelopes made from 90-g/m² (24-lb bond) paper or 25% cotton. All-cotton envelopes must not exceed 75-g/m² (20-lb bond) weight.
- Use only new envelopes from undamaged packages.
- To optimize performance and minimize jams, do not use envelopes that:
 - Have excessive curl or twist
 - Are stuck together or damaged in any way
 - Have windows, holes, perforations, cutouts, or embossing
 - Have metal clasps, string ties, or folding bars
 - Have an interlocking design
 - Have postage stamps attached

- Have any exposed adhesive when the flap is in the sealed or closed position
- Have bent corners
- Have rough, cockle, or laid finishes
- Adjust the width guides to fit the width of the envelopes.

Note: A combination of high humidity (over 60%) and high printing temperature may wrinkle or seal envelopes.

Tips on using labels

Print samples on the labels being considered for use before buying large quantities.

Note: Use only paper label sheets. Vinyl, pharmacy, and two-sided labels are not supported.

When printing on labels:

- Use labels designed specifically for laser printers. Check with the manufacturer or vendor to verify that:
 - The labels can withstand temperatures up to 230°C (446°F) without sealing, excessive curling, wrinkling, or releasing hazardous emissions.
 - Label adhesives, face sheet (printable stock), and topcoats can withstand up to 25-psi (172-kPa) pressure without delaminating, oozing around the edges, or releasing hazardous fumes.
- Do not use labels with slick backing material.
- Use full label sheets. Partial sheets may cause labels to peel off during printing, resulting in a jam. Partial sheets also contaminate the printer and the cartridge with adhesive, and could void the printer and toner cartridge warranties.
- Do not use labels with exposed adhesive.
- Do not print within 1 mm (0.04 inches) of the edge of the label, of the perforations, or between die-cuts of the label.
- Make sure the adhesive backing does not reach to the edge of the sheet. Zone coating of the adhesive should be at least 1 mm (0.04 inches) away from edges. Adhesive material contaminates the printer and could void the warranty.
- If zone coating of the adhesive is not possible, then remove a 2-mm (0.06-inches) strip on the leading and driver edge, and use a non-oozing adhesive.
- Portrait orientation is recommended, especially when printing bar codes.

Tips on using card stock

Card stock is heavy, single-ply specialty media. Many of its variable characteristics, such as moisture content, thickness, and texture, can significantly impact print quality. Print samples on the card stock being considered for use before buying large quantities.

- From the Paper menu, set the Paper Type to Card Stock.
- Select the appropriate Paper Texture setting.
- Be aware that preprinting, perforation, and creasing may significantly affect the print quality and cause jams or other paper handling problems.
- Check with the manufacturer or vendor to ensure the card stock can withstand temperatures up to 220°C (446°F) without releasing hazardous emissions.

- Do not use preprinted card stock manufactured with chemicals that may contaminate the printer. Preprinting introduces semi-liquid and volatile components into the printer.
- Use grain short card stock when possible.

Paper guidelines

Selecting the correct paper or specialty media reduces printing problems. For the best print quality, try a sample of the paper or specialty media before buying large quantities.

Paper characteristics

The following paper characteristics affect print quality and reliability. Consider these characteristics when evaluating new paper stock.

Weight

The standard printer trays can automatically feed paper weights up to 90-g/m² (24-lb) bond grain long paper. The optional trays can automatically feed paper weights up to 120-g/m² (32-lb) bond grain long paper. The multipurpose feeder can automatically feed paper weights up to 163-g/m² (43-lb) bond grain long paper. Paper lighter than 60 g/m² (16 lb) might not be stiff enough to feed properly, causing jams. For best performance, use 75-g/m² (20-lb) bond grain long paper. For paper smaller than 182 x 257 mm (7.2 x 10.1 inches), it is recommended to use 90 g/m² (24 lb) or heavier paper.

Note: Two-sided printing is supported only for 60–90-g/m² (16–24-lb) bond paper.

Curl

Curl is the tendency for paper to curl at its edges. Excessive curl can cause paper feeding problems. Curl can occur after the paper passes through the printer, where it is exposed to high temperatures. Storing paper unwrapped in hot, humid, cold, or dry conditions, even in the trays, can contribute to paper curling prior to printing and can cause feeding problems.

Smoothness

Paper smoothness directly affects print quality. If paper is too rough, toner cannot fuse to it properly. If paper is too smooth, it can cause paper feeding or print quality issues. Always use paper between 100 and 300 Sheffield points; smoothness between 150–250 Sheffield points produces the best print quality.

Moisture content

The amount of moisture in paper affects both print quality and the ability of the printer to feed the paper correctly. Leave paper in its original wrapper until it is time to use it. This limits the exposure of paper to moisture changes that can degrade its performance.

Condition paper before printing by storing it in its original wrapper in the same environment as the printer for 24–48 hours before printing. Extend the time to several days if the storage or transportation environment is very different from the printer environment. Thick paper may also require a longer conditioning period.

Grain direction

Grain refers to the alignment of the paper fibers in a sheet of paper. Grain is either *grain long*, running the length of the paper, or *grain short*, running the width of the paper.

For 60–90-g/m² (16–24-lb) bond paper, grain long paper is recommended.

Fiber content

Most high-quality xerographic paper is made from 100% chemically treated pulped wood. This content provides the paper with a high degree of stability resulting in fewer paper feeding problems and better print quality. Paper containing fibers such as cotton can negatively affect paper handling.

Unacceptable paper

The following paper types are not recommended for use with the printer:

- Chemically-treated papers used to make copies without carbon paper, also known as carbonless papers, carbonless copy paper (CCP), or no carbon required (NCR) paper
- Preprinted papers with chemicals that may contaminate the printer
- Preprinted papers that can be affected by the temperature in the printer fuser
- Preprinted papers that require a registration (the precise print location on the page) greater or lesser than ± 2.5 mm (± 0.10 inch), such as optical character recognition (OCR) forms

In some cases, registration can be adjusted with a software application to successfully print on these forms:

- Coated papers (erasable bond), synthetic papers, thermal papers
- Rough-edged, rough or heavily textured surface papers, or curled papers
- Recycled papers that fail EN12281:2002 (European)
- Paper weighing less than 60 g/m² (16 lb)
- Multiple-part forms or documents

Selecting paper

Using the appropriate paper prevents jams and helps ensure trouble-free printing.

To help avoid paper jams and poor print quality:

- *Always* use new, undamaged paper.
- Before loading paper, know the recommended printable side of the paper. This information is usually indicated on the paper package.
- *Do not* use paper that has been cut or trimmed by hand.
- *Do not* mix paper sizes, types, or weights in the same tray; mixing results in jams.
- *Do not* use coated papers unless they are specifically designed for electrophotographic printing.

Selecting preprinted forms and letterhead

Use these guidelines when selecting preprinted forms and letterhead:

- Use grain long for 60 to 90 g/m² (16 to 24 lb) weight paper.
- Use only forms and letterhead printed using an offset lithographic or engraved printing process.
- Avoid papers with rough or heavily textured surfaces.

Use papers printed with heat-resistant inks designed for use in xerographic copiers. The ink must be able to withstand temperatures up to 230°C (446°F) without melting or releasing hazardous emissions. Use inks that are not affected by the resin in toner. Inks that are oxidation-set or oil-based generally meet these requirements; latex inks might not. When in doubt, contact the paper supplier.

Preprinted papers such as letterhead must be able to withstand temperatures up to 230°C (446°F) without melting or releasing hazardous emissions.

Using recycled paper and other office papers

- Low moisture content (4–5%)
- Suitable smoothness (100–200 Sheffield units, or 140–350 Bendtsen units, European)

Note: Some much smoother papers (such as premium 24 lb laser papers, 50–90 Sheffield units) and much rougher papers (such as premium cotton papers, 200–300 Sheffield units) have been engineered to work very well in laser printers, despite surface texture. Before using these types of paper, consult your paper supplier.

- Suitable sheet-to-sheet coefficient of friction (0.4–0.6)
- Sufficient bending resistance in the direction of feed

Recycled paper, paper of lower weight (<60 g/m² [16 lb bond]) and/or lower caliper (<3.8 mils [0.1 mm]), and paper that is cut grain-short for portrait (or short-edge) fed printers may have lower bending resistance than is required for reliable paper feeding. Before using these types of paper for laser (electrophotographic) printing, consult your paper supplier. Remember that these are general guidelines only and that paper meeting these guidelines may still cause paper feeding problems in any laser printer (for example, if the paper curls excessively under normal printing conditions).

Storing paper

Use these paper storage guidelines to help avoid jams and uneven print quality:

- For best results, store paper where the temperature is 21°C (70°F) and the relative humidity is 40 percent. Most label manufacturers recommend printing in a temperature range of 18–24°C (65–75°F) with relative humidity between 40 and 60 percent.
- Store paper in cartons, on a pallet or shelf, rather than on the floor.
- Store individual packages on a flat surface.
- Do not store anything on top of individual paper packages.
- Take paper out of the carton or wrapper only when you are ready to load it in the printer. The carton and wrapper help keep the paper clean, dry, and flat.

Supported paper sizes, types, and weights

Supported paper sizes

Paper size and dimension	Standard 550-sheet tray	Optional 550-sheet tray	Multipurpose feeder	ADF	Scanner glass	Duplex printing
Business card	X	X	X	X	✓	X
3 x 5	X	X	✓ ¹	X	✓	X
4 x 6	X	X	✓ ¹	X	✓	X
A4 210 x 297 mm (8.27 x 11.7 in.)	✓	✓	✓	✓	✓	✓
A5 148 x 210 mm (5.83 x 8.27 in.)	✓	✓	✓	✓	✓	X
A6 105 x 148 mm (4.13 x 5.83 in.)	✓	X	✓	✓	✓	X
JIS B5 182 x 257 mm (7.17 x 10.1 in.)	✓	✓	✓	✓	✓	X
Letter 215.9 x 279.4 mm (8.5 x 11 in.)	✓	✓	✓	✓	✓	✓
Legal 215.9 x 355.6 mm (8.5 x 14 in.)	✓	✓	✓	✓	✓	✓
Executive 184.2 x 266.7 mm (7.25 x 10.5 in.)	✓	✓	✓	✓	✓	X
Oficio (México) 215.9 x 340.4 mm (8.5 x 13.4 in.)	✓	✓	✓	✓	✓	✓
Folio 215.9 x 330.2 mm (8.5 x 13 in.)	✓	✓	✓	✓	✓	✓

¹ Paper is supported only if the paper size setting is set to Universal.

² Paper is supported in two-sided (duplex) printing only if the width is at least 210 mm (8.27 in.) and the length is at least 279.4 mm (11 in.). The smallest supported Universal paper size is supported only in the multipurpose feeder.

Paper size and dimension	Standard 550-sheet tray	Optional 550-sheet tray	Multipurpose feeder	ADF	Scanner glass	Duplex printing
Statement 139.7 x 215.9 mm (5.5 x 8.5 in.)	✓	✓	✓	✓	✓	X
Universal² 76.2 x 127 mm (3 x 5 in.) to 215.9 x 359.92 mm (8.5 x 14.17 in.)	✓	✓	✓	✓	✓	✓ ²
7 3/4 Envelope (Monarch) 98.4 x 190.5 mm (3.875 x 7.5 in.)	X	X	✓	X	✓	X
9 Envelope 98.4 x 226.1 mm (3.875 x 8.9 in.)	X	X	✓	X	✓	X
10 Envelope 104.8 x 241.3 mm (4.12 x 9.5 in.)	X	X	✓	X	✓	X
DL Envelope 110 x 220 mm (4.33 x 8.66 in.)	X	X	✓	X	✓	X
C5 Envelope 162 x 229 mm (6.38 x 9.01 in.)	X	X	✓	X	✓	X
B5 Envelope 176 x 250 mm (6.93 x 9.84 in.)	X	X	✓	X	✓	X
Other Envelope 85.7 x 165 mm to 215.9 x 355.6 mm (3.375 x 6.50 in. to 8.5 x 14 in.)	X	X	✓	X	✓	X

¹ Paper is supported only if the paper size setting is set to Universal.

² Paper is supported in two-sided (duplex) printing only if the width is at least 210 mm (8.27 in.) and the length is at least 279.4 mm (11 in.). The smallest supported Universal paper size is supported only in the multipurpose feeder.

Supported paper types and weights

Note: Labels, transparencies, envelopes, and card stock always print at a reduced speed.

Paper type	Standard 550-sheet tray	550-sheet tray	Multipurpose feeder	Duplex mode	ADF	Scanner glass
Plain paper	✓	✓	✓	✓	✓	✓

* Use envelopes that lie flat when individually placed on a table facedown.

Paper type	Standard 550-sheet tray	550-sheet tray	Multipurpose feeder	Duplex mode	ADF	Scanner glass
Card stock	X	X	✓	X	✓	✓
Transparencies	X	X	✓	X	✓	✓
Recycled	✓	✓	✓	✓	✓	✓
Paper labels	✓	✓	✓	X	✓	✓
Bond	X	X	✓	X	✓	✓
Envelope*	✓	✓	✓	✓	✓	✓
Rough envelope	X	X	✓	X	✓	✓
Letterhead	✓	✓	✓	✓	✓	✓
Preprinted	✓	✓	✓	✓	✓	✓
Colored paper	✓	✓	✓	✓	✓	✓
Light paper	✓	✓	✓	✓	✓	✓
Heavy paper	✓	✓	✓	✓	✓	✓
Rough/Cotton	✓	✓	✓	X	✓	✓
Custom Type [x]	✓	✓	✓	✓	✓	✓

* Use envelopes that lie flat when individually placed on a table facedown.

Paper sizes, types, and weights supported by the optional finisher

Supported paper sizes

Paper size	Dimensions	Staple finisher
A4	210 x 297 mm (8.3 x 11.7 in.)	X
A5	148 x 210 mm (5.8 x 8.3 in.)	X
A6	105 x 148 mm (4.1 x 5.8 in.)	X
JIS B5	182 x 257 mm (7.2 x 10.1 in.)	X
Letter	216 x 279 mm (8.5 x 11 in.)	✓
Legal	216 x 356 mm (8.5 x 14 in.)	✓
Executive	184 x 267 mm (7.3 x 10.5 in.)	X
Oficio (México)	216 x 340 mm (8.5 x 13.4 in.)	✓
Folio	216 x 330 mm (8.5 x 13 in.)	✓
Statement	140 x 216 mm (5.5 x 8.5 in.)	X

Paper size	Dimensions	Staple finisher
Universal	105 x 216 mm to 216 x 356 mm (4.13 x 8.5 in. to 8.5 x 14 in.)	X
7 3/4 Envelope (Monarch)	98 x 191 mm (3.9 x 7.5 in.)	X
9 Envelope	98 x 225 mm (3.9 x 8.9 in.)	X
10 Envelope	105 x 241 mm (4.1 x 9.5 in.)	X
DL Envelope	110 x 220 mm (4.3 x 8.7 in.)	X
C5 Envelope	162 x 229 mm (6.38 x 9.01 in.)	X
B5 Envelope	176 x 250 mm (6.93 x 9.84 in.)	X
Other Envelope	98 x 162 mm (3.9 x 6.4 in.) to 176 x 250 mm (6.9 x 9.8 in.)	X

Supported paper types and weights



Paper type	Staple finisher
Plain paper	✓
Card stock	X
Transparencies	X
Recycled	✓
Paper labels	✓
Bond	✓
Envelope	X
Rough envelope	X
Letterhead	✓
Preprinted	✓
Colored paper	✓
Light paper	✓
Heavy paper	✓
Rough/Cotton	✓
Custom Type [x]	✓

Printing

Printing forms and a document

Printing forms

Use the Forms and Favorites application to quickly and easily access frequently used forms or other information that is regularly printed. Before you can use this application, first set it up on the printer. For more information, see [“Setting up Forms and Favorites” on page 22](#).

- 1 From the printer home screen, navigate to:
Forms and Favorites > select the form from the list > enter the number of copies > adjust other settings
- 2 Depending on your printer model, touch , , or **Submit**.

Printing a document

- 1 From the Paper menu on the printer control panel, set the paper type and size to match the paper loaded.
- 2 Send the print job:

For Windows users

- a With a document open, click **File** > **Print**.
- b Click **Properties**, **Preferences**, **Options**, or **Setup**.
- c Adjust the settings, if necessary.
- d Click **OK** > **Print**.

For Macintosh users

- a Customize the settings in the Page Setup dialog:
 - 1 With a document open, choose **File** > **Page Setup**.
 - 2 Choose a paper size or create a custom size to match the paper loaded.
 - 3 Click **OK**.
- b Customize the settings in the Print dialog:
 - 1 With a document open, choose **File** > **Print**.
If necessary, click the disclosure triangle to see more options.
 - 2 From the Print dialog and pop-up menus, adjust the settings if necessary.
Note: To print on a specific paper type, adjust the paper type setting to match the paper loaded, or select the appropriate tray or feeder.
 - 3 Click **Print**.

Adjusting toner darkness

- 1 Open a Web browser, and then type the printer IP address in the address field.

Notes:

- View the printer IP address on the printer home screen. The IP address appears as four sets of numbers separated by periods, such as 123.123.123.123.
- If you are using a proxy server, then temporarily disable it to load the Web page correctly.

2 Click **Settings > Print Settings > Quality Menu > Toner Darkness**.

3 Adjust the toner darkness, and then click **Submit**.

Using the printer control panel

1 From the home screen, navigate to:

 > **Settings > Print Settings > Quality Menu > Toner Darkness**

2 Adjust the setting, and then touch **Submit**.

Printing from a flash drive or mobile device

Printing from a flash drive

Notes:

- Before printing an encrypted PDF file, you will be prompted to type the file password from the printer control panel.
- You cannot print files for which you do not have printing permissions.

1 Insert a flash drive into the USB port.

**Notes:**

- A flash drive icon appears on the printer home screen when a flash drive is inserted.
- If you insert the flash drive when the printer requires attention, such as when a jam has occurred, then the printer ignores the flash drive.
- If you insert the flash drive while the printer is processing other print jobs, then **Busy** appears on the printer display. After these print jobs are processed, you may need to view the held jobs list to print documents from the flash drive.

Warning—Potential Damage: Do not touch the USB cable, any wireless network adapter, any connector, the memory device, or the printer in the areas shown while actively printing, reading, or writing from the memory device. Loss of data can occur.



- 2 From the printer control panel, touch the document you want to print.
- 3 Touch the arrows to get a preview of the document.
- 4 Use **+** or **-** to specify the number of copies to be printed, and then touch **Print**.

Notes:

- Do not remove the flash drive from the USB port until the document has finished printing.
- If you leave the flash drive in the printer after leaving the initial USB menu screen, then touch **Held Jobs** on the home screen to print files from the flash drive.

Printing from a mobile device using AirPrint

AirPrint™ is a mobile printing application that allows you to print directly from your iPad® (all models), iPhone® (3GS or later), or iPod touch® (3rd generation or later) to your AirPrint-enabled printer. AirPrint-enabled printers work with these mobile devices that run the latest version of iOS.

Note: Make sure the printer and the mobile device share the same wireless network. For information on configuring the wireless settings of your mobile device, see the documentation that came with the device.

- 1 From the home screen of your mobile device, launch the application.

Note: You can print any content from these Apple applications: iBook, Mail, Photos, Safari, and some select App Store applications.

- 2 Select the item to print, and then tap .
- 3 Tap **Print**, and then choose your printer.
- 4 Set the print options you want, and then tap **Print**.

Printing from a mobile device using Dell Mobile Print

You can print directly from an Android mobile device (OS 2.1 or later) to your printer using Dell Mobile Print.

Notes:

- Make sure the printer and the mobile device share the same wireless network.
- For information on configuring the wireless settings, see the documentation that came with your mobile device.

1 From Google Play, download the Dell Mobile Print application.



2 From the home screen of your mobile device, tap .

3 Select the item to print.

You can choose from the list of supported applications (such as Calendar, Contacts, Gallery, Google Docs, Gmail, Internet, Messaging, Word Documents, Excel Documents, PowerPoint Documents, and PDF Documents).

4 From the print preview dialog, set the print and printer options if necessary.

Note: If your printer does not appear in the list, then check the network settings of both your printer and your mobile device to make sure that both share the same wireless network.

5 Tap **Print**.

Supported flash drives and file types

Notes:

- High-speed USB flash drives must support the full-speed standard. Low-speed USB devices are not supported.
- USB flash drives must support the File Allocation Table (FAT) system. Devices formatted with New Technology File System (NTFS) or any other file system are not supported.

Recommended flash drives	File type
Many flash drives are tested and approved for use with the printer. For more information, visit www.dell.com/support/printers .	Documents: <ul style="list-style-type: none"> • .pdf • .xps Images: <ul style="list-style-type: none"> • .dcm • .gif • .jpeg or .jpg • .bmp • .pcx • .tiff or .tif • .png • .fls

Printing confidential and other held jobs

Storing print jobs in the printer

1 From the printer control panel, navigate to:

 > **Security** > **Confidential Print** > select the print job type

Use	To
Max Invalid PIN	Limit the number of times an invalid PIN can be entered. Note: When the limit is reached, the print jobs for that user name and PIN are deleted.
Confidential Job Expiration	Hold print jobs in the computer until you enter the PIN from the printer control panel. Note: The PIN is set from the computer. It must be four digits, using the numbers 1–9.
Repeat Job Expiration	Print and store print jobs in the printer memory.
Verify Job Expiration	Print one copy of a print job and hold the remaining copies. It allows you to examine if the first copy is satisfactory. The print job is automatically deleted from the printer memory when all copies are printed.
Reserve Job Expiration	Store print jobs for printing at a later time. Note: The print jobs are held until deleted from the Held Jobs menu.
<p>Notes:</p> <ul style="list-style-type: none"> • Confidential, Verify, Reserve, and Repeat print jobs may be deleted if the printer requires extra memory to process additional held jobs. • You can set the printer to store print jobs in the printer memory until you start the print job from the printer control panel. • All print jobs that can be initiated by the user at the printer are called <i>held jobs</i>. 	

2 Touch **Submit**.

Printing confidential and other held jobs

Note: Confidential and Verify print jobs are automatically deleted from memory after printing. Repeat and Reserve jobs are *held* in the printer until you delete them.

For Windows users

- 1 With a document open, click **File** > **Print**.
- 2 Click **Properties, Preferences, Options, or Setup**.
- 3 Click **Print and Hold**.
- 4 Select the print job type (Confidential, Repeat, Reserve, or Verify), and then assign a user name. For a confidential print job, also enter a four-digit PIN.
- 5 Click **OK** or **Print**.

6 From the printer home screen, release the print job.

- For confidential print jobs, navigate to:
Held jobs > select your user name > **Confidential Jobs** > enter the PIN > **Print**
- For other print jobs, navigate to:
Held jobs > select your user name > select the print job > specify the number of copies > **Print**

For Macintosh users

1 With a document open, choose **File** > **Print**.

If necessary, click the disclosure triangle to see more options.

2 From the print options or Copies & Pages pop-up menu, choose **Job Routing**.

3 Select the print job type (Confidential, Repeat, Reserve, or Verify), and then assign a user name. For a confidential print job, also enter a four-digit PIN.

4 Click **OK** or **Print**.

5 From the printer home screen, release the print job.

- For confidential print jobs, navigate to:
Held jobs > select your user name > **Confidential Jobs** > enter the PIN > **Print**
- For other print jobs, navigate to:
Held jobs > select your user name > select the print job > specify the number of copies > **Print**

Modifying confidential print settings

1 Open a Web browser, and then type the printer IP address in the address field.

Notes:

- View the printer IP address on the printer home screen. The IP address appears as four sets of numbers separated by periods, such as 123.123.123.123.
- If you are using a proxy server, then temporarily disable it to load the Web page correctly.

2 Click **Settings** > **Security** > **Confidential Print Setup**.

3 Modify the settings:

- Set a maximum number of PIN entry attempts. When a user exceeds that number, all of the jobs for that user are deleted.
- Set an expiration time for confidential print jobs. When a user has not printed the jobs within that time, all of the jobs for that user are deleted.

4 Click **Submit** to save the modified settings.

Printing information pages

Printing a font sample list

- 1 From the home screen, navigate to:



> **Reports** > **Print Fonts**

- 2 Touch **PCL Fonts** or **PostScript Fonts**.

Printing a directory list

A directory list shows the resources stored in a flash memory or in the printer hard disk.

From the home screen, navigate to:



> **Reports** > **Print Directory**

Canceling a print job

Canceling a print job from the printer control panel

- 1 From the printer control panel, touch **Cancel Job** or press  on the keypad.
- 2 Touch the print job you want to cancel, and then touch **Delete Selected Jobs**.

Note: If you press  on the keypad, then touch **Resume** to return to the home screen.

Canceling a print job from the computer



For Windows users

- 1 Open the printers folder, and then select your printer.
- 2 From the print queue, select the print job you want to cancel, and then delete it.

For Macintosh users

- 1 From System Preferences in the Apple menu, navigate to your printer.
- 2 From the print queue, select the print job you want to cancel, and then delete it.

Copying

Automatic document feeder (ADF)	Scanner glass
 <p data-bbox="149 825 612 852">Use the ADF for multiple-page documents.</p>	 <p data-bbox="630 825 1409 915">Use the scanner glass for single pages, small items (such as postcards or photos), transparencies, photo paper, or thin media (such as magazine clippings).</p>

Making copies

Making a quick copy

- 1 Load an original document faceup, short edge first into the ADF tray or facedown on the scanner glass.

Notes:

- Do not load postcards, photos, small items, transparencies, photo paper, or thin media (such as magazine clippings) into the ADF tray. Place these items on the scanner glass.
- The ADF indicator light comes on when the paper is loaded properly.

- 2 If you are loading a document into the ADF tray, then adjust the paper guides.

Note: To avoid a cropped image, make sure the size of the original document and the size of the copy paper are the same.

- 3 From the printer control panel, press .

Copying using the ADF

- 1 Load an original document faceup, short edge first into the ADF tray.

Notes:

- Do not load postcards, photos, small items, transparencies, photo paper, or thin media (such as magazine clippings) into the ADF tray. Place these items on the scanner glass.
- The ADF indicator light comes on when the paper is loaded properly.



- 2 Adjust the paper guides.

- 3 From the home screen, navigate to:
Copy > specify the copy settings > **Copy It**

Copying using the scanner glass

- 1 Place an original document facedown on the scanner glass in the upper left corner.
- 2 From the home screen, navigate to:
Copy > specify the copy settings > **Copy It**
If you have more pages to scan, then place the next document on the scanner glass, and then touch **Scan the next page**.
- 3 Touch **Finish the Job**.

Copying photos

- 1 Place a photo facedown on the scanner glass in the upper left corner.
- 2 From the home screen, navigate to:
Copy > **Content** > **Photo** > 
- 3 From the Content Source menu, navigate to:
Photo/Film >  > **Copy It**
Note: If you have more photos to copy, then place the next photo on the scanner glass, and then touch **Scan the next page**.
- 4 Touch **Finish the Job**.

Copying on specialty media

Copying on transparencies

- 1 Load an original document faceup, short edge first into the ADF tray or facedown on the scanner glass.

Notes:

- Do not load postcards, photos, small items, transparencies, photo paper, or thin media (such as magazine clippings) into the ADF tray. Place these items on the scanner glass.
- The ADF indicator light comes on when the paper is loaded properly.



- 2 From the home screen, navigate to:

Copy > **Copy from** > select the size of the original document > 

3 Navigate to:

Copy to > select the tray that contains transparencies > **Copy It**

If there are no trays that contain transparencies, then navigate to:

Manual Feeder >  > select the size of the transparencies >  > **Transparency** > 

4 Load transparencies into the multipurpose feeder, and then touch **Copy It**.

Copying on letterhead

1 Load an original document faceup, short edge first into the ADF tray or facedown on the scanner glass.

Notes:

- Do not load postcards, photos, small items, transparencies, photo paper, or thin media (such as magazine clippings) into the ADF tray. Place these items on the scanner glass.
- The ADF indicator light comes on when the paper is loaded properly.

2 If you are loading a document into the ADF tray, then adjust the paper guides.

3 From the home screen, navigate to:

Copy > **Copy from** > select the size of the original document > 

4 Navigate to:

Copy to > select the tray containing the letterhead > **Copy It**

5 If there are no trays that support letterhead, then navigate to:

Manual Feeder > select the size of the letterhead > **Letterhead**

6 Load the letterhead faceup, top edge first into the multipurpose feeder, and then touch **Copy It**.

Customizing copy settings

Copying to a different size

1 Load an original document faceup, short edge first into the ADF tray or facedown on the scanner glass.

Notes:

- Do not load postcards, photos, small items, transparencies, photo paper, or thin media (such as magazine clippings) into the ADF tray. Place these items on the scanner glass.
- The ADF indicator light comes on when the paper is loaded properly.

2 If you are loading a document into the ADF tray, then adjust the paper guides.

3 From the home screen, navigate to:

Copy > **Copy from** > select the size of the original document > 

4 Navigate to:

Copy to > select a new size for the copy >  > **Copy It**

Making copies using paper from a selected tray

- 1 Load an original document faceup, short edge first into the ADF tray or facedown on the scanner glass.

Notes:

- Do not load postcards, photos, small items, transparencies, photo paper, or thin media (such as magazine clippings) into the ADF tray. Place these items on the scanner glass.
- The ADF indicator light comes on when the paper is loaded properly.

- 2 If you are loading a document into the ADF tray, then adjust the paper guides.
- 3 From the home screen, navigate to:

Copy > Copy from > select the size of the original document > 

- 4 Navigate to:

Copy to > select the tray containing the paper type you want to use > 

- 5 Touch **Copy It**.

Copying different paper sizes

Use the ADF to copy original documents with different paper sizes. Depending on the paper sizes loaded and the “Copy to” and “Copy from” settings, each copy is either printed on mixed paper sizes (Example 1) or scaled to fit a single paper size (Example 2).

Example 1: Copying on mixed paper sizes

- 1 Load an original document faceup, short edge first into the ADF tray or facedown on the scanner glass.

Notes:

- Do not load postcards, photos, small items, transparencies, photo paper, or thin media (such as magazine clippings) into the ADF tray. Place these items on the scanner glass.
- The ADF indicator light comes on when the paper is loaded properly.

- 2 If you are loading a document into the ADF tray, then adjust the paper guides.
- 3 From the home screen, navigate to:

Copy > Copy from > **Mixed Sizes** > 

- 4 Navigate to:

Copy to > **Auto Size Match** >  > **Copy It**

The scanner identifies the different paper sizes as they are scanned. Copies are printed on mixed paper sizes corresponding to the paper sizes of the original document.

Example 2: Copying on a single paper size

- 1 Load an original document faceup, short edge first into the ADF tray or facedown on the scanner glass.

Notes:

- Do not load postcards, photos, small items, transparencies, photo paper, or thin media (such as magazine clippings) into the ADF tray. Place these items on the scanner glass.

- The ADF indicator light comes on when the paper is loaded properly.

2 If you are loading a document into the ADF tray, then adjust the paper guides.

3 From the home screen, navigate to:

Copy > Copy from > Mixed Sizes > 

4 Navigate to:

Copy to > Letter >  **> Copy It**

The scanner identifies the different paper sizes as they are scanned, and then scales the mixed paper sizes to fit on the paper size selected.

Copying on both sides of the paper (duplexing)

1 Load an original document faceup, short edge first into the ADF tray or facedown on the scanner glass.

Notes:

- Do not load postcards, photos, small items, transparencies, photo paper, or thin media (such as magazine clippings) into the ADF tray. Place these items on the scanner glass.
- The ADF indicator light comes on when the paper is loaded properly.

2 If you are loading a document into the ADF tray, then adjust the paper guides.

3 From the home screen, navigate to:

Copy > Sides (Duplex) > select the preferred duplexing method

Note: For the preferred duplexing method, the first number represents sides of the original documents while the second number represents sides of the copy. For example, select “2 sided to 2 sided” if you have two-sided original documents and you want two-sided copies.

4 Touch  **> Copy It.**

Reducing or enlarging copies

Copies can be scaled from 25% to 400% of the original document size.

1 Load an original document faceup, short edge first into the ADF tray or facedown on the scanner glass.

Notes:

- Do not load postcards, photos, small items, transparencies, photo paper, or thin media (such as magazine clippings) into the ADF tray. Place these items on the scanner glass.
- The ADF indicator light comes on when the paper is loaded properly.

2 If you are loading a document into the ADF tray, then adjust the paper guides.

3 From the home screen, touch **Copy**.

- 4 From the Scale area, touch  or  to decrease or increase the value by 1%.

Touching “Copy to” or “Copy from” after setting Scale manually changes the scale value back to Auto.

Note: Auto is the factory default setting. This automatically adjusts the scan image of the original document to fit the size of the paper onto which you are copying.

- 5 Touch **Copy It**.

Adjusting copy quality

- 1 Load an original document faceup, short edge first into the ADF tray or facedown on the scanner glass.

Notes:

- Do not load postcards, photos, small items, transparencies, photo paper, or thin media (such as magazine clippings) into the ADF tray. Place these items on the scanner glass.
- The ADF indicator light comes on when the paper is loaded properly.

- 2 If you are loading a document into the ADF tray, then adjust the paper guides.

- 3 From the home screen, navigate to:

Copy > Content

- 4 Touch the button that best represents the content type of the document you are copying.

- **Text**—The content of the original document is mostly text or line art.
- **Text/Photo**—The original document is a mixture of text, graphics, and photos.
- **Photo**—The original document is mostly a photo or an image.
- **Graphics**—The original document is mostly business-type graphics, such as pie charts, bar charts, and animations.

- 5 Touch .

- 6 Touch the button that best represents the content source of the document you are copying.

- **Color Laser**—The original document was printed using a color laser printer.
- **Inkjet**—The original document was printed using an inkjet printer.
- **Magazine**—The original document is from a magazine.
- **Press**—The original document was printed using a printing press.
- **Black/White Laser**—The original document was printed using a mono laser printer.
- **Photo/Film**—The original document is a photo from a film.
- **Newspaper**—The original document is from a newspaper.
- **Other**—The original document was printed using an alternate or unknown printer.

- 7 Touch  > **Copy It**.

Collating copies

If you print multiple copies of a document, then you can choose to print the copies as a set (collated) or to print the copies as groups of pages (not collated).

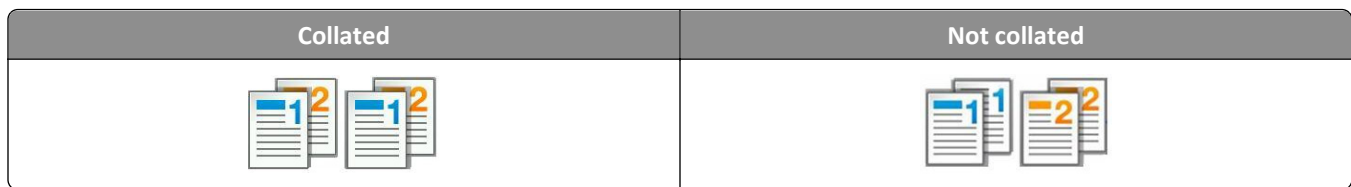

1 Load an original document faceup, short edge first into the ADF tray or facedown on the scanner glass.

Notes:

- Do not load postcards, photos, small items, transparencies, photo paper, or thin media (such as magazine clippings) into the ADF tray. Place these items on the scanner glass.
- The ADF indicator light comes on when the paper is loaded properly.

2 If you are loading a document into the ADF tray, then adjust the paper guides.

3 From the home screen, navigate to:

Copy > enter the number of copies > **Collate** > select the preferred order of pages >  > **Copy It**

Placing separator sheets between copies

1 Load an original document faceup, short edge first into the ADF tray or facedown on the scanner glass.

Notes:

- Do not load postcards, photos, small items, transparencies, photo paper, or thin media (such as magazine clippings) into the ADF tray. Place these items on the scanner glass.
- The ADF indicator light comes on when the paper is loaded properly.

2 If you are loading a document into the ADF tray, then adjust the paper guides.

3 From the home screen, navigate to:

Copy > **Advanced Options** > **Separator Sheets**

Note: Set Collate to “1,2,3 - 1,2,3” to place separator sheets between copies. If Collate is set to “1,1,1 - 2,2,2,” then the separator sheets are added to the end of the copy job. For more information, see [“Collating copies” on page 86](#).

4 Select one of the following:

- **Between Copies**
- **Between Jobs**
- **Between Pages**
- **Off**

5 Touch  > **Copy It**.

Copying multiple pages onto a single sheet

In order to save paper, you can copy either two or four consecutive pages of a multiple-page document onto a single sheet of paper.

Notes:

- Make sure to set the paper size to letter, legal, A4, or JIS B5.
- Make sure to set the copy size to 100%.

1 Load an original document faceup, short edge first into the ADF tray or facedown on the scanner glass.

Notes:

- Do not load postcards, photos, small items, transparencies, photo paper, or thin media (such as magazine clippings) into the ADF tray. Place these items on the scanner glass.
- The ADF indicator light comes on when the paper is loaded properly.

2 If you are loading a document into the ADF tray, then adjust the paper guides.

3 From the home screen, navigate to:

Copy > Advanced Options > Paper Saver > select the output you want >  > Copy It

Note: If Paper Saver is set to Off, then the Print Page Borders option is unavailable.

Creating a custom copy job

The custom copy job or job build is used to combine one or more sets of original documents into a single copy job. Each set may be scanned using different job parameters. When a copy job is submitted and Custom Job is enabled, the scanner scans the first set of original documents using the specified settings, and then it scans the next set with the same or different settings.

The definition of a set depends on the scan source:

- If you scan a document on the scanner glass, then a set consists of one page.
- If you scan multiple pages using the ADF, then a set consists of all scanned pages until the ADF tray becomes empty.
- If you scan one page using the ADF, then a set consists of one page.

For example:

1 Load an original document faceup, short edge first into the ADF tray or facedown on the scanner glass.

Notes:

- Do not load postcards, photos, small items, transparencies, photo paper, or thin media (such as magazine clippings) into the ADF tray. Place these items on the scanner glass.
- The ADF indicator light comes on when the paper is loaded properly.

2 If you are loading a document into the ADF tray, then adjust the paper guides.

3 From the home screen, navigate to:

Copy > Advanced Options > Custom Job > On >  > Copy It

Note: When the end of a set is reached, the scan screen appears.

4 Load the next document faceup, short edge first into the ADF tray or facedown on the scanner glass, and then touch **Scan from automatic feeder** or **Scan from flatbed**.

Note: Change the scan job settings, if necessary.

5 If you have another document to scan, then repeat the previous step. Otherwise, touch **Finish the job**.

Placing information on copies

Placing a header or footer on pages

- 1 Load an original document faceup, short edge first into the ADF tray or facedown on the scanner glass.

Notes:



- Do not load postcards, photos, small items, transparencies, photo paper, or thin media (such as magazine clippings) into the ADF tray. Place these items on the scanner glass.
- The ADF indicator light comes on when the paper is loaded properly.

- 2 If you are loading a document into the ADF, then adjust the paper guides.

- 3 From the home screen, navigate to:

Copy > Advanced Options > Header/Footer > select where you want to place the header or footer > select the type of header or footer you want

- 4 Enter the required information depending on the header or footer you selected, and then touch **Done**.

- 5 Touch , and then press .

Placing an overlay message on each page

An overlay message can be placed on each page. The message choices are Urgent, Confidential, Copy, Custom, and Draft.

- 1 Load an original document faceup, short edge first into the ADF tray or facedown on the scanner glass.

Notes:

- Do not load postcards, photos, small items, transparencies, photo paper, or thin media (such as magazine clippings) into the ADF tray. Place these items on the scanner glass.
- The ADF indicator light comes on when the paper is loaded properly.

- 2 If you are loading a document into the ADF tray, then adjust the paper guides.

- 3 From the home screen, navigate to:

Copy > Advanced Options > Overlay > select overlay message > Done > Copy It

Canceling a copy job

Canceling a copy job while the original document is in the ADF

When the ADF begins processing a document, touch **Cancel Job** on the printer control panel.

Canceling a copy job while copying pages using the scanner glass

From the home screen, touch **Cancel Job**.

Canceling appears on the display. When the job is canceled, the Copy screen appears.

Canceling a copy job while pages are being printed

- 1 From the printer control panel, touch **Cancel Job** or press  on the keypad.
- 2 Touch the job you want to cancel, and then touch **Delete Selected Jobs**.

Note: If you press  on the keypad, then touch **Resume** to return to the home screen.

Understanding the copy options

Copy from

This option opens a screen where you can select the paper size of the original document.

- Touch the paper size that matches the original document.
- To copy an original document that contains mixed paper sizes with the same width, touch **Mixed Sizes**.
- To set the printer to automatically detect the size of the original document, touch **Auto Size Sense**.



Copy to

This option opens a screen where you can enter the paper size and type on which your copies will be printed.

- Touch the paper size and type that matches the paper loaded.
- If the settings for “Copy from” and “Copy to” are different, then the printer automatically adjusts the Scale setting to accommodate the difference.
- If the paper type or size that you want to copy onto is not loaded in one of the trays, then touch **Manual Feeder**, and manually load the paper in the multipurpose feeder.
- When “Copy to” is set to Auto Size Match, each copy matches the paper size of the original document. If a matching paper size is not in one of the trays, then **Paper size not found** appears and prompts to load a paper in a tray or multipurpose feeder.

Scale

This option lets you scale the document from 25% to 400% of the original document size. You can also set automatic scaling.

- When copying to a different paper size, such as from legal-size to letter-size paper, set the “Copy from” and “Copy to” paper sizes automatically to scale the scan image to fit the size of the paper onto which you are copying.
- To decrease or increase the value by 1%, touch  or  on the printer control panel. To make a continuous decrease or increase in value, hold the button for two seconds or more.

Darkness

This option lets you adjust how light or dark the copies are in relation to the original document.

Sides (Duplex)

This option lets you make one- or two-sided copies from one- or two-sided original documents.

Collate

This option keeps the pages of a print job stacked in sequence when printing multiple copies of the document.

Copies

This option lets you set the number of copies to be printed.

Content

This option lets you set the original document type and source.

Select from the following content types:

- **Text**—The content of the original document is mostly text or line art.
- **Text/Photo**—The original document is a mixture of text, graphics, and photos.
- **Photo**—The original document is mostly a photo or an image.
- **Graphics**—The original document is mostly business-type graphics, such as pie charts, bar charts, and animations.

Select from the following content sources:

- **Color Laser**—The original document was printed using a color laser printer.
- **Inkjet**—The original document was printed using an inkjet printer.
- **Magazine**—The original document is from a magazine.
- **Brochure**—The original document is from a brochure.
- **Black/White Laser**—The original document was printed using a mono laser printer.
- **Photo/Film**—The original document is a photo from film.
- **Newspaper**—The original document is from a newspaper.
- **Other**—The original document was printed using an alternate or unknown printer.

Save As Shortcut

This option lets you save the current settings by assigning a shortcut number.



Using the advanced options

Select from the following settings:

- **Advanced Imaging**—This adjusts the Background Removal, Color Balance, Color Dropout, Contrast, JPEG Quality, Mirror Image, Negative Image, Scan Edge to Edge, Shadow Detail, and Sharpness settings before you scan the document.
- **Custom Job**—This combines multiple scanning jobs into a single job.
- **Edge Erase**—This removes smudges or marks around the edges of a document. You can choose to remove an equal area around all four sides of the paper, or pick a particular edge. Edge Erase erases whatever is within the area selected, leaving nothing on that portion of the scan.
- **Transmission Log**—This prints the transmission log or transmission error log.
- **Adjust ADF Skew**—This straightens scanned images that are slightly skewed when received from the ADF tray.

Note: This option is supported only in select printer models.

E-mailing

Automatic document feeder (ADF)	Scanner glass
 <p>Use the ADF for multiple-page documents.</p>	 <p>Use the scanner glass for single pages, small items (such as postcards or photos), transparencies, photo paper, or thin media (such as magazine clippings).</p>

You can use the printer to e-mail scanned documents to one or more recipients in a number of ways. You can type the e-mail address, use a shortcut number, or use the address book.

Setting up the printer to e-mail

Setting up the e-mail function

- 1 Open a Web browser, and then type the printer IP address in the address field.

Notes:

- View the printer IP address on the printer home screen. The IP address appears as four sets of numbers separated by periods, such as 123.123.123.123.
- If you are using a proxy server, then temporarily disable it to load the Web page correctly.

- 2 Click **Settings > E-mail/FTP Settings > E-mail Settings**.
- 3 Enter the appropriate information, and then click **Submit**.

Configuring e-mail settings

- 1 Open a Web browser, and then type the printer IP address in the address field.

Notes:

- View the printer IP address on the printer home screen. The IP address appears as four sets of numbers separated by periods, such as 123.123.123.123.
- If you are using a proxy server, then temporarily disable it to load the Web page correctly.

- 2 Click **Settings > E-mail/FTP Settings > E-mail Settings**.

- 3 Enter the appropriate information, and then click **Submit**.

Creating an e-mail shortcut

Creating an e-mail shortcut using the Embedded Web Server

- 1 Open a Web browser, and then type the printer IP address in the address field.

Notes:

- View the printer IP address on the printer home screen. The IP address appears as four sets of numbers separated by periods, such as 123.123.123.123.
- If you are using a proxy server, then temporarily disable it to load the Web page correctly.

- 2 Click **Settings**.
- 3 From the Other Settings column, click **Manage Shortcuts > E-mail Shortcut Setup**.
- 4 Type a unique name for the e-mail recipient, and then type the e-mail address. If you are entering multiple addresses, then separate each address with a comma.
- 5 Click **Add**.

Creating an e-mail shortcut using the printer control panel

- 1 From the home screen, navigate to:
E-mail > Recipient > type an e-mail address
To create a group of recipients, touch **Next address**, and then type the next recipient's e-mail address.
- 2 Touch **Subject**, then type the e-mail subject, and then touch **Done**.
- 3 Touch **Message**, then type your message, and then touch **Done**.
- 4 Adjust the e-mail settings.
Note: If you change the settings after the e-mail shortcut has been created, then the settings are not saved.

- 5 Touch .
- 6 Type a unique name for the shortcut, and then touch **Done**.
- 7 Verify that the shortcut name is correct, and then touch **OK**.
If the shortcut name is incorrect, then touch **Cancel**, and then reenter the information.

Notes:

- The shortcut name appears in the E-mail Shortcuts icon on the printer home screen.
- You can use the shortcut when e-mailing another document using the same settings.

E-mailing a document

You can use the printer to e-mail scanned documents to one or more recipients in a number of ways. You can type the e-mail address, use a shortcut number, or use the address book. You can also use the Multi Send or MyShortcut application from the printer home screen. For more information, see [“Activating the home screen applications” on page 22](#).

Sending an e-mail using the printer control panel

- 1 Load an original document faceup, short edge first into the ADF tray or facedown on the scanner glass.

Notes:

- Do not load postcards, photos, small items, transparencies, photo paper, or thin media (such as magazine clippings) into the ADF tray. Place these items on the scanner glass.
- The ADF indicator light comes on when the paper is loaded properly.

- 2 If you are loading a document into the ADF tray, then adjust the paper guides.

Note: To avoid a cropped image, make sure that the size of the original document and the copy paper size are the same.

- 3 From the home screen, navigate to:

E-mail > Recipient(s)

- 4 Type the e-mail address, or press # using the keypad, and then enter the shortcut number.

Notes:

- To enter additional recipients, touch **Next address**, and then enter the address or shortcut number you want to add.
- You can also enter an e-mail address using the address book.

- 5 Touch **Done > Send It**.

Sending an e-mail using a shortcut number

- 1 Load an original document faceup, short edge first into the ADF tray or facedown on the scanner glass.

Notes:

- Do not load postcards, photos, small items, transparencies, photo paper, or thin media (such as magazine clippings) into the ADF tray. Place these items on the scanner glass.
- The ADF indicator light comes on when the paper is loaded properly.

- 2 If you are loading a document into the ADF tray, then adjust the paper guides.

- 3 Press #, then enter the shortcut number using the keypad, and then touch .

Note: To enter additional recipients, touch **Next address**, and then enter the address or shortcut number that you want to add.

- 4 Touch **Send It**.

Sending an e-mail using the address book

- 1 Load an original document faceup, short edge first into the ADF tray or facedown on the scanner glass.

Notes:

- Do not load postcards, photos, small items, transparencies, photo paper, or thin media (such as magazine clippings) into the ADF tray. Place these items on the scanner glass.
- The ADF indicator light comes on when the paper is loaded properly.

- 2 If you are loading a document into the ADF tray, then adjust the paper guides.
- 3 From the home screen, navigate to:

E-mail > **Recipient(s)** >  > type the name of the recipient > **Search**

- 4 Touch the name of the recipient.

Note: To enter additional recipients, touch **Next address**, and then enter the address or shortcut number that you want to add, or search the address book.

- 5 Touch **Done**.

Customizing e-mail settings

Adding e-mail subject and message information

- 1 Load an original document faceup, short edge first into the ADF tray or facedown on the scanner glass.

Notes:

- Do not load postcards, photos, small items, transparencies, photo paper, or thin media (such as magazine clippings) into the ADF tray. Place these items on the scanner glass.
- The ADF indicator light comes on when the paper is loaded properly.

- 2 If you are loading a document into the ADF tray, then adjust the paper guides.
- 3 From the home screen, navigate to:

E-mail > **Recipient(s)** > type the e-mail address > **Done**

- 4 Touch **Subject**, then type the e-mail subject, and then touch **Done**.
- 5 Touch **Message**, then type your message, and then touch **Done**.

Changing the output file type

- 1 Load an original document faceup, short edge first into the ADF tray or facedown on the scanner glass.

Notes:

- Do not load postcards, photos, small items, transparencies, photo paper, or thin media (such as magazine clippings) into the ADF tray. Place these items on the scanner glass.
- The ADF indicator light comes on when the paper is loaded properly.

- 2 If you are loading a document into the ADF tray, then adjust the paper guides.

3 From the home screen, navigate to:

E-mail > Recipient(s) > type the e-mail address > Done > Send as

4 Touch the button that represents the file type you want to send.

- **PDF**—Create a single file with multiple pages.
- **Secure PDF**—Create an encrypted PDF file that protects the file contents from unauthorized access.
- **TIFF**—Create multiple files or a single file. If Multi-page TIFF is turned off in the Settings menu of the Embedded Web Server, then TIFF saves one page in each file. The file size is usually larger than an equivalent JPEG.
- **JPEG**—Create and attach a separate file for each page of your original document, viewable by most Web browsers and graphics programs.
- **XPS**—Create a single XML Paper Specification (XPS) file with multiple pages, viewable using an Internet Explorer-hosted viewer and the .NET Framework, or by downloading a third-party standalone viewer.

5 Touch  > **Send It.**

Note: If you selected Secure PDF, then you will be prompted to enter your password twice.

Canceling an e-mail

- When using the ADF, touch **Cancel Job** while **Scanning** appears.
- When using the scanner glass, touch **Cancel Job** while **Scanning** appears, or while **Scan the Next Page / Finish the Job** appears.

Understanding the e-mail options

Recipient(s)

This option lets you enter the recipient of your e-mail. You may enter multiple e-mail addresses.

Subject

This option lets you type a subject line for your e-mail.

Message

This option lets you type a message that will be sent with your scanned attachment.

File Name

This option lets you customize the attachment file name.

Original Size

This option lets you set the paper size of the documents you are going to e-mail. When Original Size is set to Mixed Sizes, you can scan an original document that contains mixed paper sizes (letter- and legal-size pages).

Darkness

This option lets you adjust how light or dark your scanned documents are in relation to the original document.

Resolution

This option lets you adjust the output quality of your e-mail. Increasing the image resolution increases the e-mail file size and the time needed to scan your original document. Decreasing the image resolution reduces the file size.

Send As

This option lets you set the output type for the scan image.

Select one of the following:

- **PDF**—Use this to create a single file with multiple pages.
Note: PDF is the factory default setting.
- **Secure PDF**—Use this to create an encrypted PDF file that protects the file contents from unauthorized access.
- **TIFF**—Use this to create multiple files or a single file. If Multi-page TIFF is turned off in the Settings menu of the Embedded Web Server, then TIFF saves one page in each file. The file size is usually larger than an equivalent JPEG.
- **JPEG**—Use this to create and attach a separate file for each page of your original document.
- **XPS**—Use this to create a single XPS file with multiple pages.

Content

This option lets you set the original document type and source.

Select from the following content types:

- **Text**—The content of the original document is mostly text or line art.
- **Text/Photo**—The original document is a mixture of text, graphics, and photos.
- **Photo**—The original document is mostly a photo or an image.
- **Graphics**—The original document is mostly business-type graphics, such as pie charts, bar charts, and animations.

Select from the following content sources:

- **Color Laser**—The original document was printed using a color laser printer.
- **Inkjet**—The original document was printed using an inkjet printer.
- **Magazine**—The original document is from a magazine.
- **Brochure**—The original document is from a brochure.
- **Black/White Laser**—The original document was printed using a mono laser printer.
- **Photo/Film**—The original document is a photo from film.
- **Newspaper**—The original document is from a newspaper.
- **Other**—The original document was printed using an alternate or unknown printer.

Page Setup

This option lets you change the following settings:

- **Sides (Duplex)**—This specifies if the original document is printed on only one side or on both sides of the paper. This also identifies what needs to be scanned for inclusion in the e-mail.
- **Orientation**—This specifies the orientation of the original document, and then changes the Sides (Duplex) and Binding settings to match the orientation.
- **Binding**—This specifies if the original document is bound on the long-edge or short-edge side.

Scan Preview

This option lets you view the first page of the image before it is included in the e-mail. When the first page is scanned, the scanning is paused and a preview image appears.

Note: This option appears only when a working printer hard disk is installed.

Using the advanced options



Select from the following settings:

- **Advanced Imaging**—This adjusts the Background Removal, Color Balance, Color Dropout, Contrast, JPEG Quality, Mirror Image, Negative Image, Scan Edge to Edge, Shadow Detail, and Sharpness settings before you e-mail the document.
- **Custom Job**—This combines multiple scanning jobs into a single job.
- **Edge Erase**—This removes smudges or marks around the edges of a document. You can choose to remove an equal area around all four sides of the paper, or pick a particular edge. Edge Erase will erase whatever is within the area selected, leaving nothing on that portion of the scan.
- **Transmission Log**—This prints the transmission log or transmission error log.
- **Adjust ADF Skew**—This straightens scanned images that are slightly skewed when received from the ADF tray.

Note: This option is supported only in select printer models.

Faxing

Note: Fax capabilities may not be available on all printer models.

Automatic document feeder (ADF)	Scanner glass
 <p>Use the ADF for multiple-page documents.</p>	 <p>Use the scanner glass for single pages, small items (such as postcards or photos), transparencies, photo paper, or thin media (such as magazine clippings).</p>

Setting up the printer to fax

CAUTION—SHOCK HAZARD: Do not use the fax feature during a lightning storm. Do not set up this product or make any electrical or cabling connections, such as the fax feature, power cord, or telephone, during a lightning storm.

Notes:

- The following connection methods are applicable only in select countries or regions.
- During the initial printer setup, clear the fax function check box and any other function you plan to set up later, and then press **Continue**.
- The indicator light may blink red if the fax function is enabled but not fully set up.

Warning—Potential Damage: Do not touch the cables or the printer in the area shown while actively sending or receiving a fax.



Initial fax setup

Many countries and regions require outgoing faxes to contain the following information in a margin at the top or bottom of each transmitted page, or on the first page of the transmission: fax name (identification of the business, other entity, or individual sending the message) and fax number (telephone number of the sending fax machine, business, other entity, or individual).

To enter your fax setup information, use the printer control panel, or use your browser to access the Embedded Web Server and then enter the Settings menu.

Note: If you do not have a TCP/IP environment, then you must use the printer control panel to enter your fax setup information.

Using the printer control panel for fax setup

When the printer is turned on for the first time, a series of start-up screens appear. If the printer has fax capabilities, then the Fax Name and Fax Number screens appear.

- 1 When the Fax Name screen appears, do the following:
 - a Enter the name to be printed on all outgoing faxes.
 - b Enter the fax name, and then touch **Submit**.
- 2 When the Fax Number screen appears, enter the fax number, and then touch **Submit**.

Using the Embedded Web Server for fax setup

- 1 Open a Web browser, and then type the printer IP address in the address field.

Notes:

- View the printer IP address on the printer home screen. The IP address appears as four sets of numbers separated by periods, such as 123.123.123.123.
- If you are using a proxy server, then temporarily disable it to load the Web page correctly.

- 2 Click **Settings > Fax Settings > Analog Fax Setup**.
- 3 In the Fax Name field, type the name to be printed on all outgoing faxes.
- 4 In the Fax Number field, enter the printer fax number.
- 5 Click **Submit**.

Choosing a fax connection

Scenario 1: Standard telephone line

Setup 1: Printer is connected to a dedicated fax line

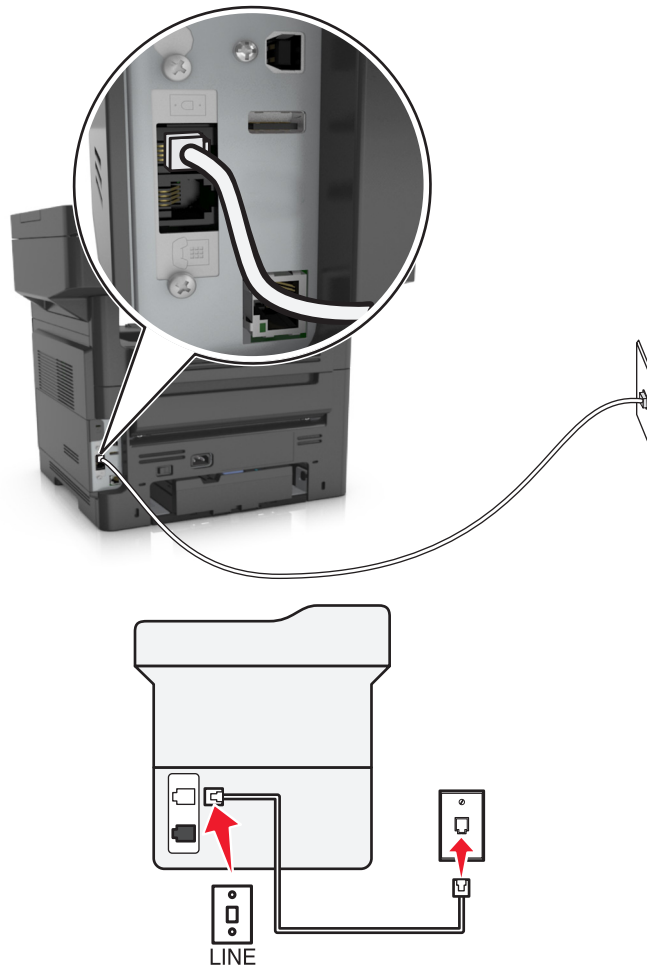



To connect:

- 1 Connect one end of the telephone cable that came with the printer to the  port of the printer.
- 2 Connect the other end of the telephone cable to an active analog wall jack.

Tips for this setup:

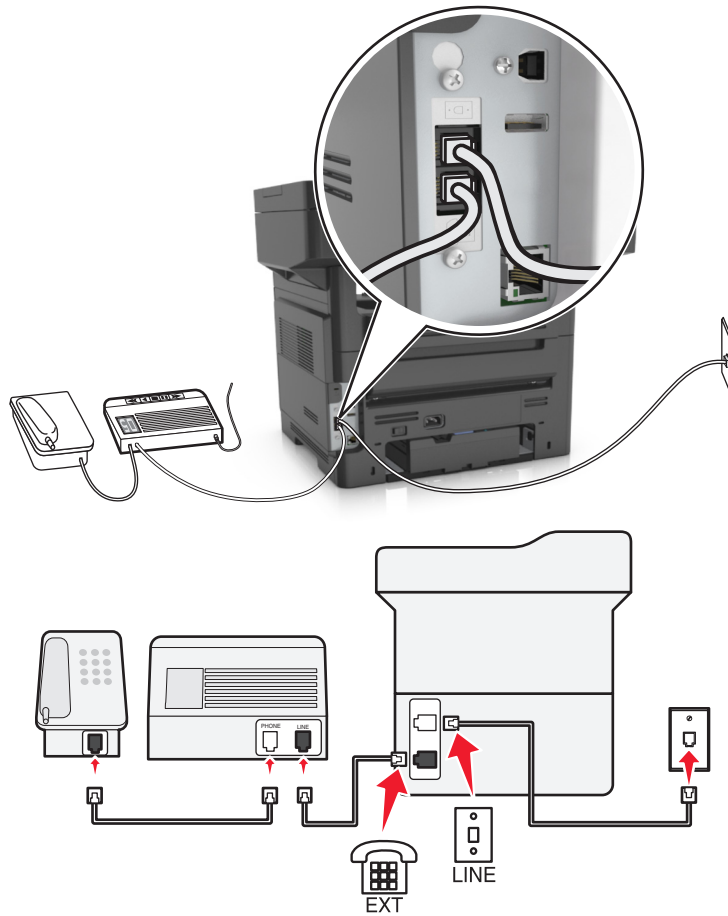
- You can set the printer to receive faxes automatically (Auto Answer On) or manually (Auto Answer Off).
- If you want to receive faxes automatically (Auto Answer On), then set the printer to pick up on any number of rings that you want.

Setup 2: Printer is sharing the line with an answering machine**Connected to the same telephone wall jack****To connect:**

- 1 Connect one end of the telephone cable that came with the printer to the  port of the printer.
- 2 Connect the other end of the telephone cable to an active analog wall jack.
- 3 Connect the answering machine to the  port of the printer.

Connected to different wall jacks

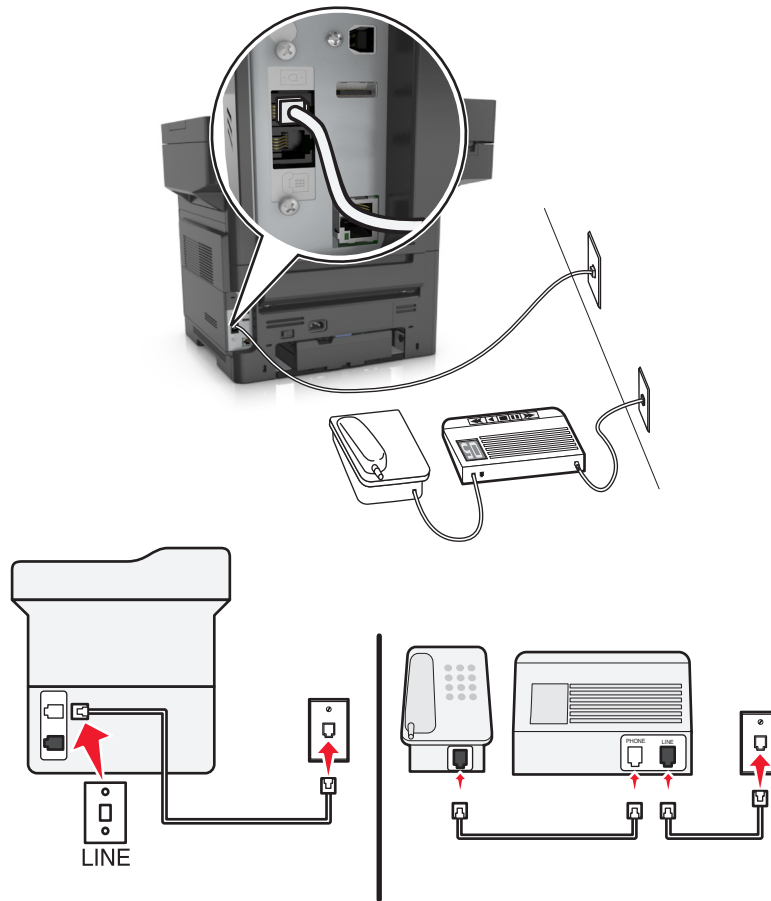

To connect:

- 1 Connect one end of the telephone cable that came with the printer to the  port of the printer.
- 2 Connect the other end of the telephone cable to an active analog wall jack.



Tips for this setup:

- If you have only one telephone number on your line, then you need to set the printer to receive faxes automatically (Auto Answer On).
- Set the printer to pick up calls two rings after the answering machine. For example, if the answering machine picks up calls after four rings, then set the printer to pick up after six rings. This way, the answering machine picks up calls first and your voice calls are received. If the call is a fax, then the printer detects the fax signal on the line and takes over the call.
- If you subscribe to a distinctive ring service provided by your telephone company, then make sure that you set the correct ring pattern for the printer. Otherwise, the printer does not receive faxes even if you have set it to receive faxes automatically.

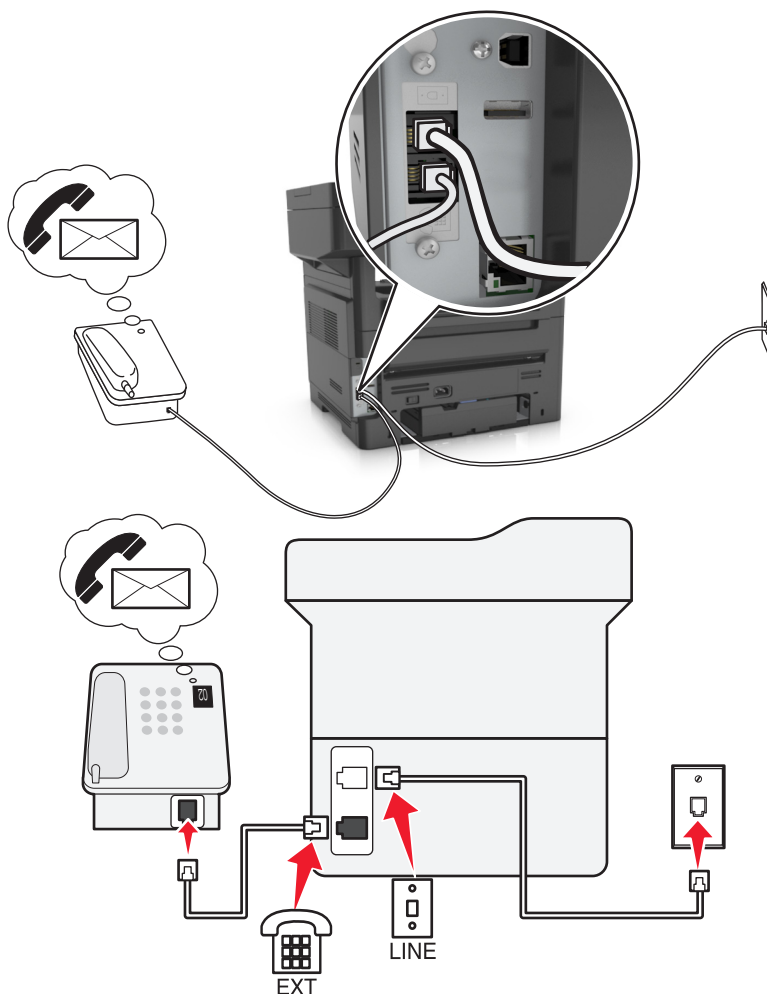
Setup 3: Printer is sharing the line with a telephone subscribed to voice mail service



To connect:

- 1 Connect one end of the telephone cable that came with the printer to the  port of the printer.
- 2 Connect the other end of the telephone cable to an active analog wall jack.
- 3 Connect the telephone to the  port of the printer.

Tips for this setup:

- This setup works best if you subscribe to a distinctive ring service. If you have distinctive ring service, then make sure that you set the correct ring pattern for the printer. Otherwise, the printer does not receive faxes even if you have set it to receive faxes automatically.
- If you have only one telephone number on your line, then you need to set the printer to receive faxes manually (Auto Answer Off).

When you answer the telephone and you hear fax tones, press ***9*** or the manual answer code on the telephone to receive the fax.

- You can also set the printer to receive faxes automatically (Auto Answer On), but you need to turn off the voice mail service when you are expecting a fax. This setting works best if you are using voice mail more often than fax.

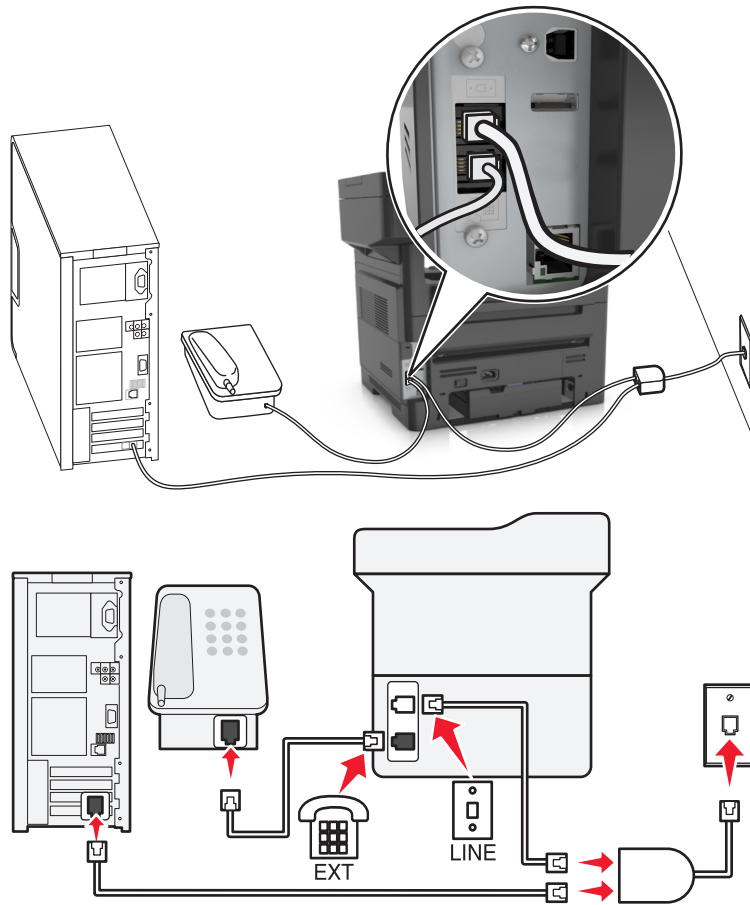

Scenario 2: Digital Subscriber Line (DSL)



A Digital Subscriber Line splits your regular telephone line into two channels: voice and Internet. Telephone and fax signals travel through the voice channel, and Internet signals pass through the other channel. This way, you can use the same line for analog voice calls (including faxes) and digital Internet access.

To minimize interference between the two channels and ensure a quality connection, you need to install a DSL filter for the analog devices (fax machine, telephone, answering machine) in your network. Interference causes noise and static on the telephone, failed and poor quality faxes for the printer, and slow Internet connection on your computer.



To install a filter for the printer:

- 1 Connect the line port of the DSL filter to the wall jack.
- 2 Connect one end of the telephone cable that came with your printer to the  port of the printer. Connect the other end to the phone port on the DSL filter.
- 3 To continue using a computer for Internet access, connect the computer to the DSL HPN port on the DSL filter.
- 4 To connect a telephone to the printer, remove any installed adapter plug from the  port of the printer, and then connect the telephone to the port.

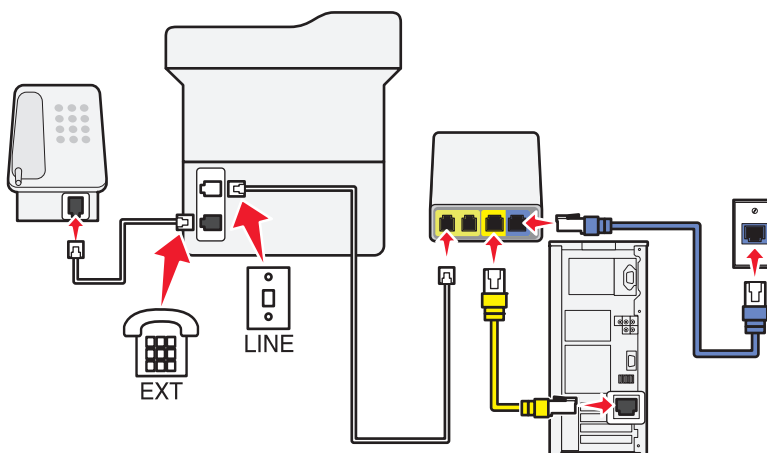
Scenario 3: VoIP telephone service



To connect:

- 1 Connect one end of a telephone cable to the  port of the printer.
- 2 Connect the other end of the cable to the port labeled **Phone Line 1** or **Phone Port** on the VoIP adapter.
The port labeled **Phone Line 2** or **Fax Port** is not always active. You may need to pay extra to your VoIP provider if you want to activate the second phone port.
- 3 Remove the protective plug from the  port of the printer, and then connect the telephone to the port.

Tips for this setup:

- To make sure that the phone port on the VoIP adapter is active, plug an analog telephone into the phone port, and then listen for a dial tone. If you hear a dial tone, then the port is active.
- If you need two phone ports for your devices but do not want to pay extra, then do not plug the printer into the second phone port. You can use a phone splitter. Plug the phone splitter into the **Phone Line 1** or **Phone Port**, and then plug the printer and telephone into the splitter.

Make sure you use a phone splitter, *not* a line splitter. To make sure that you are using the correct splitter, plug an analog telephone into the splitter and then listen for a dial tone.

Scenario 4: Digital telephone service through a cable provider

Setup 1: Printer is connected directly to a cable modem

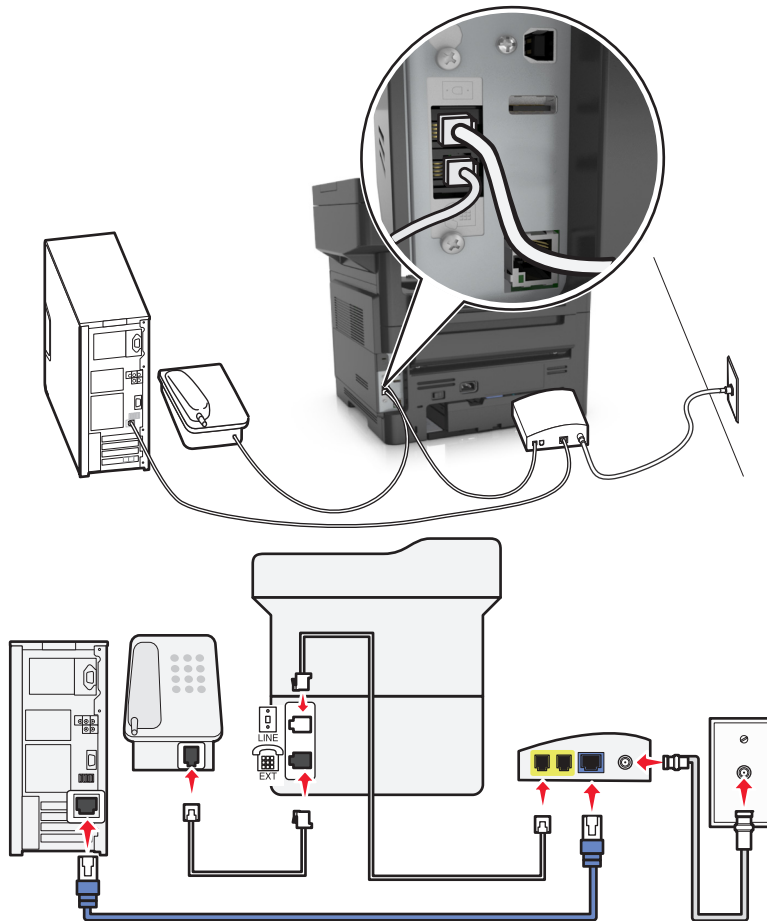

- 1 Connect one end of the telephone cable that came with your printer to the  port of the printer.
- 2 Connect the other end of the cable to the port labeled **Phone Line 1** or **Phone Port** on the cable modem.



Note: The port labeled **Phone Line 2** or **Fax Port** is not always active. VoIP providers may charge additional cost for activation of the second phone port.

- 3 Connect your analog telephone phone to the  port of the printer.

Notes:

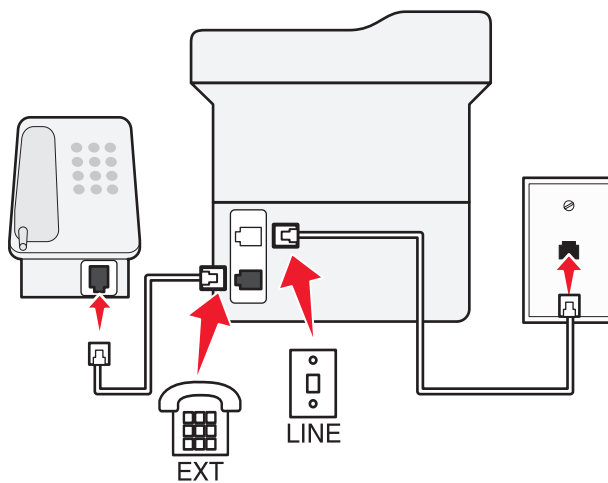
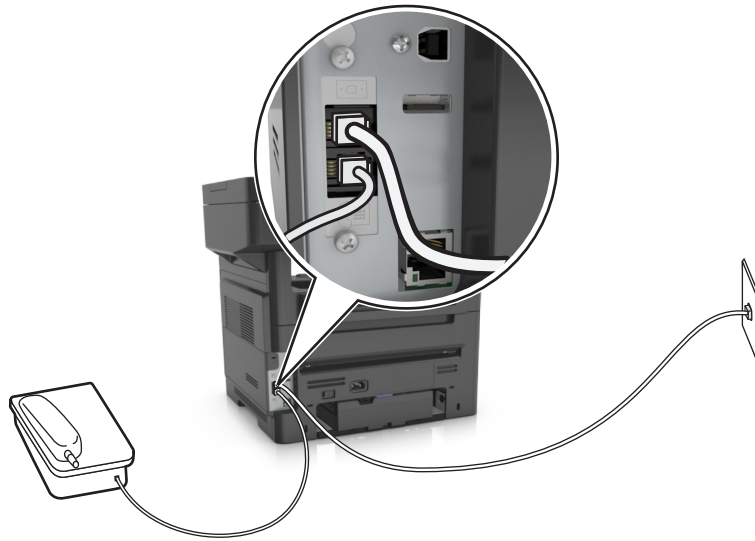
- To make sure that the telephone port on the cable modem is active, plug an analog telephone into the telephone port, and then listen for a dial tone. If you hear a dial tone, then the port is active.
- If you need two telephone ports for your devices, but do not want to pay additional cost, then do not plug the printer into the second telephone port. You can use a phone splitter. Plug the phone splitter into the **Phone Line 1** or **Phone Port**, and then plug the printer and telephone into the splitter.
- Make sure you use a phone splitter, *not* a line splitter. To make sure that you are using the correct splitter, plug an analog telephone into the splitter and then listen for a dial tone.

Setup 2: Printer is connected to a wall jack; cable modem is installed elsewhere in the facility



- 1 Connect one end of the telephone cable that came with your printer to the  port of the printer.
- 2 Connect the other end of the telephone cable to an active analog telephone wall jack.
- 3 Connect your analog telephone to the  port of the printer.

Scenario 5: Countries or regions with different telephone wall jacks and plugs

Some countries or regions may have different types of telephone wall jack connectors than those that came with the printer. The standard wall jack adopted by most countries or regions is RJ-11. Your printer comes with the RJ-11 jack and a telephone cable with the RJ-11 plug.

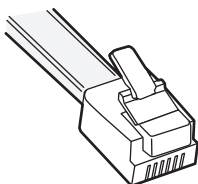
If the wall jack or equipment in your facility is not compatible with this type of connection, then you need to use a telephone adapter. An adapter for your country or region may not come with your printer, and you may need to purchase it separately.



There may be an adapter plug installed in the  port of the printer. If you are using a telephone adapter or a facility that has a cascaded or serial wiring scheme, then do not remove the adapter plug from the  port of the printer.

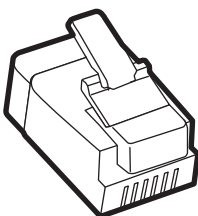

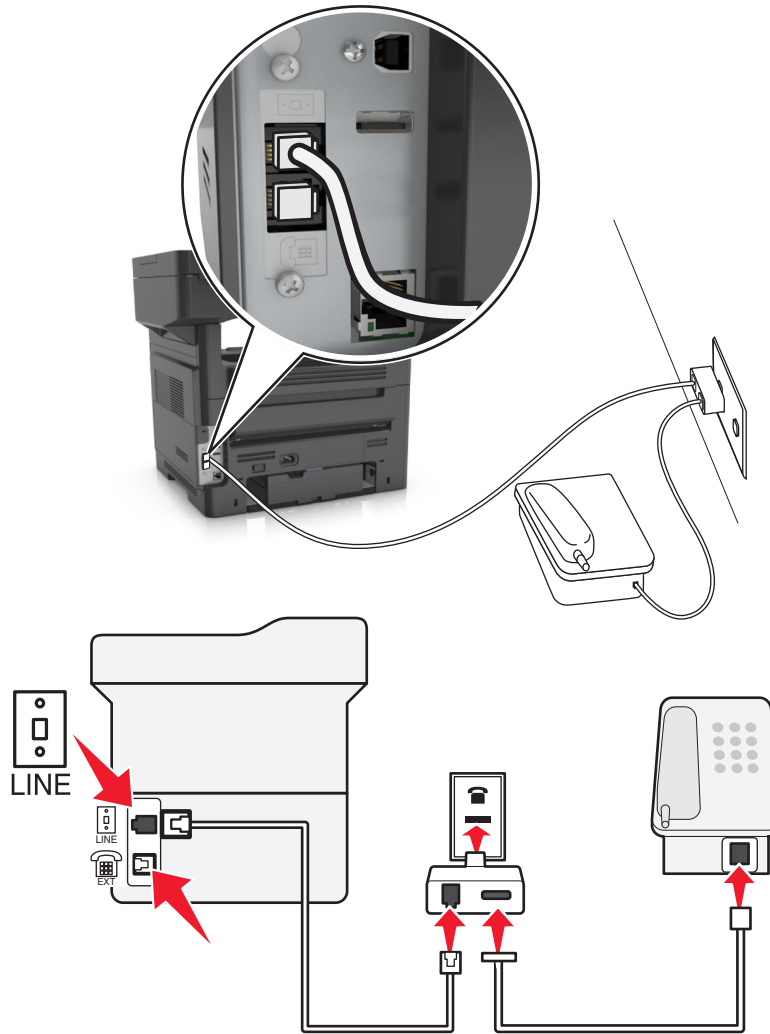

Connecting the printer to a non-RJ-11 wall jack



- 1** Connect one end of the telephone cable that came with printer to the  port of the printer.
- 2** Connect the other end of the cable to the RJ-11 adapter, and then connect the adapter to the wall jack.
- 3** If you want to connect another device (telephone or answering machine) to the same wall jack, and if the device has a non-RJ-11 connector, then connect it directly to the telephone adapter.

Notes:

- The  port of the printer may have an adapter plug for use with the adapter. Do *not* remove the plug from the  port of the printer.
- In some countries or regions, the printer may not come with a telephone adapter or an adapter plug.

Connecting the printer to a wall jack in Germany

The German wall jack has two kinds of ports. The N ports are for fax machines, modems, and answering machines. The F port is for telephones.

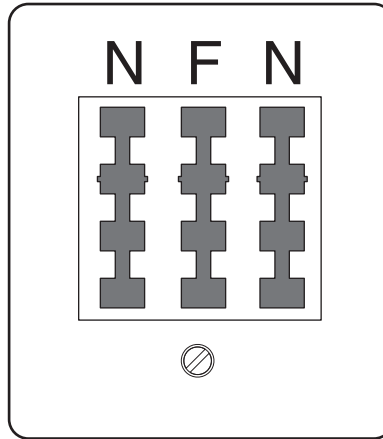

Connect the printer to any of the N ports.

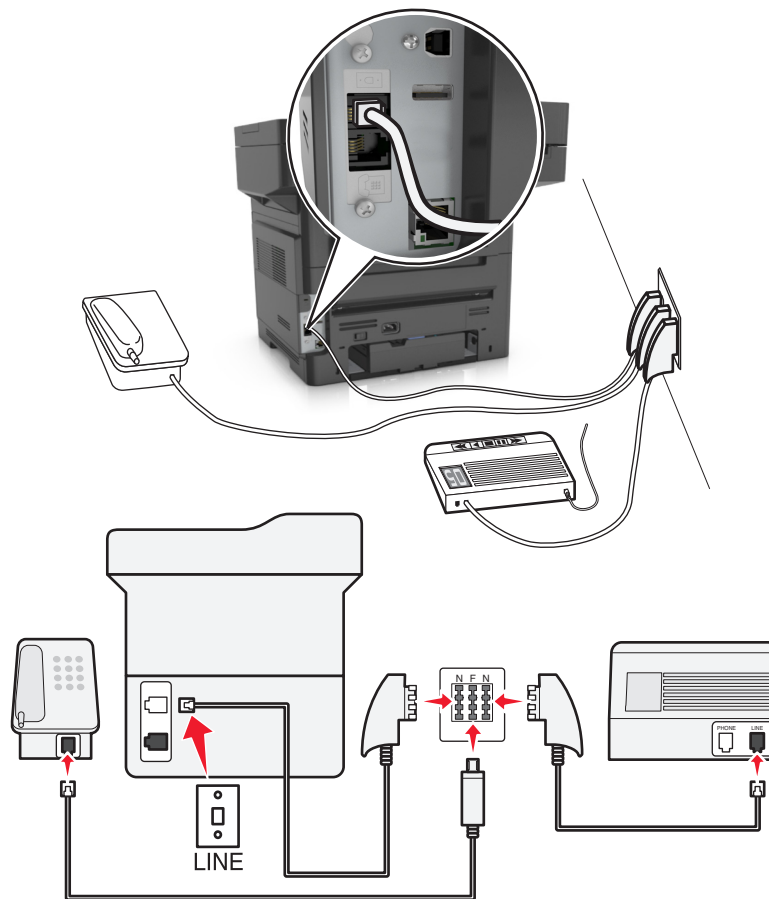

- 1 Connect one end of the telephone cable that came the printer to the  port of the printer.
- 2 Connect the other end of the telephone cable to the RJ-11 adapter, and then connect the adapter to an N port.
- 3 If you want to connect a telephone and answering machine to the same wall jack, then connect the devices as shown.

Note: Do *not* remove the adapter plug from the  port of the printer if you are connecting to a serial or cascaded telephone system.

Connecting to a distinctive ring service

A distinctive ring service may be available from your telephone company. This service lets you have multiple telephone numbers on one telephone line, with each telephone number having a different ring pattern. This may be useful for distinguishing between fax and voice calls. If you subscribe to a distinctive ring service, then follow these steps to connect the equipment:

- 1 Connect one end of the telephone cable that came with the printer to the printer LINE port .
- 2 Connect the other end of the telephone cable to an active analog telephone wall jack.

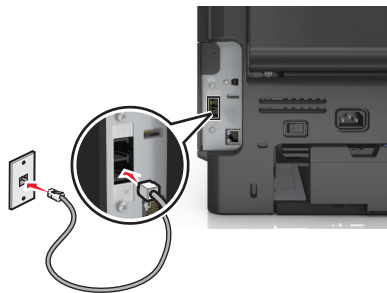

- 3 Change the distinctive rings setting to match the setting you want for the printer to answer.

Note: The factory default setting for distinctive rings is On. This sets the printer to answer single, double, and triple ring patterns.

- a From the home screen, navigate to:

 > **Settings** > **Fax Settings** > **Analog Fax Setup** > **Answer On**

- b Select the pattern setting you want to change, and then touch .

Setting the outgoing fax name and number

- 1 Open a Web browser, and then type the printer IP address in the address field.

Notes:

- View the printer IP address on the printer home screen. The IP address appears as four sets of numbers separated by periods, such as 123.123.123.123.
- If you are using a proxy server, then temporarily disable it to load the Web page correctly.

- 2 Click **Settings** > **Fax Settings** > **Analog Fax Setup**.
- 3 In the Fax Name field, type the name to be printed on all outgoing faxes.
- 4 In the Fax Number field, enter the printer fax number.
- 5 Click **Submit**.

Setting the date and time

You can set the date and time so that they are printed on every fax you send.

- 1 Open a Web browser, and then type the printer IP address in the address field.

Notes:

- View the printer IP address on the printer home screen. The IP address appears as four sets of numbers separated by periods, such as 123.123.123.123.
- If you are using a proxy server, then temporarily disable it to load the Web page correctly.

- 2 Click **Security > Set Date and Time**.

- 3 In the Manually Set Date & Time field, enter the current date and time.

- 4 Click **Submit**.

Note: It is recommended to use the network time.

Configuring the printer to observe daylight saving time

The printer can be set to automatically adjust for daylight saving time:

- 1 Open a Web browser, and then type the printer IP address in the address field.

Notes:

- View the printer IP address on the printer home screen. The IP address appears as four sets of numbers separated by periods, such as 123.123.123.123.
- If you are using a proxy server, then temporarily disable it to load the Web page correctly.

- 2 Click **Security > Set Date and Time**.

- 3 Select the **Automatically Observe DST** check box, and then enter the DST start and end dates in the Custom Time Zone Setup section.

- 4 Click **Submit**.

Sending a fax

You can use the printer to send a fax to one or more recipients in a number of ways. You can type the e-mail address, use a shortcut number, or use the address book. You can also use the Multi Send or MyShortcut application from the printer home screen. For more information, see [“Activating the home screen applications” on page 22](#).

Sending a fax using the printer control panel

- 1 Load an original document faceup, short edge first into the ADF tray or facedown on the scanner glass.

Notes:

- Do not load postcards, photos, small items, transparencies, photo paper, or thin media (such as magazine clippings) into the ADF tray. Place these items on the scanner glass.
- The ADF indicator light comes on when the paper is loaded properly.

- 2 If you are loading a document into the ADF tray, then adjust the paper guides.

3 From the home screen, touch **Fax**.

4 Enter the fax number or a shortcut.

Note: To add recipients, touch **Next number**, and then enter the recipient's telephone number or shortcut number, or search the address book.

5 Touch **Fax It**.

Sending a fax using the computer

The printer driver fax option lets you send a print job to the printer, which sends the job as a fax. The fax option works as a normal fax machine, but is controlled through the printer driver instead of the printer control panel.

1 With a document open, click **File > Print**.

2 Select the printer, and then click **Properties, Preferences, Options, or Setup**.

3 Navigate to:

Fax tab > Enable fax

4 Enter the recipient fax number or numbers in the "Fax number(s)" field.

Note: Fax numbers can be entered manually or by using the Phone Book feature

5 If necessary, enter a prefix in the "Dialing prefix" field.

6 Select the appropriate paper size and page orientation.

7 If you want to include a cover page with the fax, then select **Include cover page with fax**, and then enter the appropriate information.

8 Click **OK**.

Notes:

- The Fax option is available for use only with the PostScript driver or the Universal Fax Driver. For information on installing these drivers, see the *Software and Documentation CD*.
- The Fax option must be configured and enabled in the PostScript driver under the Configuration tab before it can be used.
- If the **Always display settings prior to faxing** check box is selected, then you are prompted to verify the recipient information before the fax is sent. If this check box is cleared, then the queued document is sent automatically as a fax when you click **OK** on the Fax tab.

Sending a fax using a shortcut number

Fax shortcuts are like the speed dial numbers on a telephone or a fax machine. A shortcut number (1–999) can contain a single recipient or multiple recipients.

1 Load an original document faceup, short edge first into the ADF tray or facedown on the scanner glass.

Notes:

- Do not load postcards, photos, small items, transparencies, photo paper, or thin media (such as magazine clippings) into the ADF tray. Place these items on the scanner glass.

- The ADF indicator light comes on when the paper is loaded properly.
- 2 If you are loading a document into the ADF tray, then adjust the paper guides.
 - 3 From the printer control panel, press #, and then enter the shortcut number using the keypad.
 - 4 Touch **Fax It**.

Sending a fax using the address book

The address book lets you search for bookmarks and network directory servers. For more information on enabling the address book feature, contact your system support person.

- 1 Load an original document faceup, short edge first into the ADF tray or facedown on the scanner glass.

Notes:

- Do not load postcards, photos, small items, transparencies, photo paper, or thin media (such as magazine clippings) into the ADF tray. Place these items on the scanner glass.
 - The ADF indicator light comes on when the paper is loaded properly.
- 2 If you are loading a document into the ADF tray, then adjust the paper guides.
 - 3 From the home screen, navigate to:

Fax >  > type the name of the recipient > **Search**

Note: You can search only for one name at a time.

- 4 Touch the name of the recipient, and then touch **Fax It**.

Sending a fax at a scheduled time

- 1 Load an original document faceup, short edge first into the ADF tray or facedown on the scanner glass.

Notes:

- Do not load postcards, photos, small items, transparencies, photo paper, or thin media (such as magazine clippings) into the ADF tray. Place these items on the scanner glass.
 - The ADF indicator light comes on when the paper is loaded properly.
- 2 If you are loading a document into the ADF tray, then adjust the paper guides.
 - 3 From the home screen, navigate to:

Fax > enter the fax number > **Delayed Send**

Note: If Fax Mode is set to Fax Server, then the Delayed Send button will not appear. Faxes waiting for transmission are listed in the fax queue.

- 4 Specify the time the fax will be transmitted, and then touch .

The time is increased or decreased in 30-minute increments.

- 5 Touch **Fax It**.

Note: The document is scanned and then faxed at the scheduled time.

Creating shortcuts

Creating a fax destination shortcut using the Embedded Web Server

Assign a shortcut number to a single fax number or a group of fax numbers.

- 1 Open a Web browser, and then type the printer IP address in the address field.

Notes:

- View the printer IP address on the printer home screen. The IP address appears as four sets of numbers separated by periods, such as 123.123.123.123.
- If you are using a proxy server, then temporarily disable it to load the Web page correctly.

- 2 Click **Settings > Manage Shortcuts > Fax Shortcut Setup**.

Note: A password may be required. If you do not have an ID and password, then contact your system support person.

- 3 Type a name for the shortcut, and then enter the fax number.

Notes:

- To create a multiple-number shortcut, enter the fax numbers for the group.
- Separate each fax number in the group with a semicolon (;).

- 4 Assign a shortcut number.

Note: If you enter a number that is already in use, then you are prompted to select another number.

- 5 Click **Add**.

Creating a fax destination shortcut using the printer control panel

- 1 From the home screen, touch **Fax**, and then enter the fax number.

Note: To create a group of fax numbers, touch **Next number**, and then enter the next fax number.

- 2 Touch .

- 3 Type a unique name for the shortcut, and then touch **Done**.

- 4 Verify that the shortcut name and number are correct, and then touch **OK**.

Note: If the name or number is incorrect, then touch **Cancel**, and then reenter the information.

Customizing fax settings

Changing the fax resolution

- 1 Load an original document faceup, short edge first into the ADF tray or facedown on the scanner glass.

Notes:

- Do not load postcards, photos, small items, transparencies, photo paper, or thin media (such as magazine clippings) into the ADF tray. Place these items on the scanner glass.
- The ADF indicator light comes on when the paper is loaded properly.

2 If you are loading a document into the ADF tray, then adjust the paper guides.

3 From the home screen, navigate to:

Fax > enter the fax number > **Options**

4 From the Resolution area, touch the arrows to select the resolution you want.

Note: Select a resolution from Standard (fastest speed) to Ultra Fine (best quality at a reduced speed).

5 Touch **Fax It**.

Making a fax lighter or darker

1 Load an original document faceup, short edge first into the ADF tray or facedown on the scanner glass.

Notes:

- Do not load postcards, photos, small items, transparencies, photo paper, or thin media (such as magazine clippings) into the ADF tray. Place these items on the scanner glass.
- The ADF indicator light comes on when the paper is loaded properly.

2 If you are loading a document into the ADF tray, then adjust the paper guides.

3 From the home screen, navigate to:

Fax > enter the fax number > **Options**

4 Adjust the fax darkness, and then touch **Fax It**.

Viewing a fax log

1 Open a Web browser, and then type the printer IP address in the address field.

Notes:

- View the printer IP address on the printer home screen. The IP address appears as four sets of numbers separated by periods, such as 123.123.123.123.
- If you are using a proxy server, then temporarily disable it to load the Web page correctly.

2 Click **Settings** > **Reports**.

3 Click **Fax Job Log** or **Fax Call Log**.

Blocking junk faxes

1 Open a Web browser, and then type the printer IP address in the address field.

Notes:

- View the printer IP address on the printer home screen. The IP address appears as four sets of numbers separated by periods, such as 123.123.123.123.

- If you are using a proxy server, then temporarily disable it to load the Web page correctly.

2 Click **Settings > Fax Settings > Analog Fax Setup > Block No Name Fax**.

Notes:

- This option blocks all incoming faxes that have a private caller ID or have no fax name.
- In the Banned Fax List field, enter the phone numbers or type the fax names of specific fax callers you want to block.

Canceling an outgoing fax

Canceling a fax while the original documents are still scanning

- When using the ADF, touch **Cancel Job** on the printer control panel while **Scanning** appears.
- When using the scanner glass, touch **Cancel Job** on the printer control panel while **Scanning** appears or while **Scan the Next Page** and **Finish the Job** appear.

Canceling a fax after the original documents have been scanned to memory

1 On the home screen, touch **Cancel Jobs**.

The Cancel Jobs screen appears.

2 Touch the job or jobs you want to cancel.

Only three jobs appear on the screen; touch the down arrow until the job you want appears, and then touch the job you want to cancel.

3 Touch **Delete Selected Jobs**.

The Deleting Selected Jobs screen appears, the selected jobs are deleted, and then the home screen appears.

Holding and forwarding faxes

Holding faxes

This option lets you hold received faxes from printing until they are released. Held faxes can be released manually or at a scheduled day or time.

1 Open a Web browser, and then type the printer IP address in the address field.

Notes:

- View the printer IP address on the printer home screen. The IP address appears as four sets of numbers separated by periods, such as 123.123.123.123.
- If you are using a proxy server, then temporarily disable it to load the Web page correctly.

2 Click **Settings > Fax Settings > Analog Fax Setup > Holding Faxes**.

- 3 From the Held Fax Mode menu, select one of the following:
 - **Off**
 - **Always On**
 - **Manual**
 - **Scheduled**
- 4 If you selected Scheduled, then continue with the following steps:
 - a Click **Fax Holding Schedule**.
 - b From the Action menu, select **Hold faxes**.
 - c From the Time menu, select the time you want the held faxes released.
 - d From the Day(s) menu, select the day you want the held faxes released.
- 5 Click **Add**.

Forwarding a fax

This option lets you print and forward received faxes to a fax number, e-mail address, FTP site, or LDSS.

- 1 Open a Web browser, and then type the printer IP address in the address field.

Notes:

- View the printer IP address on the printer home screen. The IP address appears as four sets of numbers separated by periods, such as 123.123.123.123.
- If you are using a proxy server, then temporarily disable it to load the Web page correctly.

- 2 Click **Settings > Fax Settings**.
- 3 From the Fax Forwarding menu, select **Print**, **Print and Forward**, or **Forward**.
- 4 From the “Forward to” menu, select **Fax**, **E-mail**, **FTP**, **LDSS**, or **eSF**.
- 5 In the “Forward to Shortcut” field, enter the shortcut number where you want the fax forwarded.
Note: The shortcut number must be valid for the setting selected in the “Forward to” menu.
- 6 Click **Submit**.

Understanding the fax options

Content

This option lets you specify the content type and source of the original document.

Select from the following content types:

- **Text**—The content of the original document is mostly text or line art.
- **Text/Photo**—The original document is a mixture of text, graphics, and photos.
- **Photo**—The original document is mostly a photo or an image.
- **Graphics**—The original document is mostly business-type graphics, such as pie charts, bar charts, and animations.

Select from the following content sources:

- **Color Laser**—The original document was printed using a color laser printer.
- **Inkjet**—The original document was printed using an inkjet printer.
- **Magazine**—The original document is from a magazine.
- **Brochure**—The original document is from a brochure.
- **Black/White Laser**—The original document was printed using a mono laser printer.
- **Photo/Film**—The original document is a photo from film.
- **Newspaper**—The original document is from a newspaper.
- **Other**—The original document was printed using an alternate or unknown printer.

Resolution

This option lets you adjust the quality of the fax output. Increasing the image resolution increases the file size and the time needed to scan your original document. Decreasing the image resolution reduces the file size.

Select one of the following:

- **Standard**—Use this when faxing most documents.
- **Fine 200 dpi**—Use this when faxing documents with small prints.
- **Super fine 300 dpi**—Use this when faxing documents with fine details.
- **Ultra fine 600 dpi**—Use this when faxing documents with pictures or photos.

Darkness

This option lets you adjust how light or dark the faxes are in relation to the original document.

Delayed Send

This option lets you send a fax at a later time or date.

Page Setup

This option lets you change the following settings:

- **Sides (Duplex)**—This specifies if the original document is printed on one side or on both sides of the page (duplex). This also identifies what needs to be scanned for inclusion in the fax.
- **Orientation**—This specifies the orientation of the original document, and then changes the Sides (Duplex) and Binding settings to match the orientation.
- **Binding**—This specifies if the original document is bound on the long-edge or short-edge side.

Scan Preview

This option lets you view the first page of the image before it is included in the fax. When the first page is scanned, the scanning is paused and a preview image appears.

Note: This option appears only when a working printer hard disk is installed.

Using the advanced options

Select from the following settings:

- **Advanced Imaging**—This adjusts the Background Removal, Color Balance, Color Dropout, Contrast, Mirror Image, Negative Image, Scan Edge to Edge, Shadow Detail, and Sharpness settings before you fax the document.
- **Custom Job**—This combines multiple scanning jobs into a single job.
- **Edge Erase**—This removes smudges or marks around the edges of a document. You can choose to remove an equal area around all four sides of the paper, or pick a particular edge. Edge Erase erases whatever is within the area selected, leaving nothing on that portion of the scan.
- **Transmission Log**—This prints the transmission log or transmission error log.
- **Adjust ADF Skew**—This straightens scanned images that are slightly skewed when received from the ADF tray.

Note: This option is supported only in select printer models.

Scanning

You can use the printer to send a file to an FTP address. You can type the e-mail address, use a shortcut number, or use the address book. You can also use the Multi-send or MyShortcut application from the printer home screen. For more information, see [“Activating the home screen applications” on page 22](#).

Using Scan to Network

Scan to Network lets you scan your documents to network destinations specified by your system support person. After the destinations (shared network folders) have been established on the network, the setup process for the application involves installing and configuring the application on the appropriate printer using its Embedded Web Server. For more information, see [“Setting up Scan to Network” on page 24](#).

Scanning to an FTP address

Creating shortcuts

Instead of entering the entire FTP site address on the printer control panel each time you want to send a document to an FTP server, you can create a permanent FTP destination and assign a shortcut number. There are two methods for creating shortcut numbers: using the Embedded Web Server or using the printer control panel.

Creating an FTP shortcut using the Embedded Web Server

- 1 Open a Web browser, and then type the printer IP address in the address field.

Notes:

- View the printer IP address on the printer home screen. The IP address appears as four sets of numbers separated by periods, such as 123.123.123.123.
- If you are using a proxy server, then temporarily disable it to load the Web page correctly.

- 2 Navigate to:

Settings > Other Settings area > Manage Shortcuts > FTP Shortcut Setup

- 3 Enter the appropriate information.

Note: A password may be required. If you do not have an ID and password, then contact your system support person.

- 4 Enter a shortcut number.

Note: If you enter a number that is already in use, then you are prompted to select another number.

- 5 Click **Add**.

Creating an FTP shortcut using the printer control panel

1 From the home screen, navigate to:

FTP > FTP > type the FTP address >  > type a name for the shortcut > Done

2 Verify that the shortcut name and number are correct, and then touch **OK**.

Notes:

- If the name or number is incorrect, then touch **Cancel**, and then reenter the information.
- If you enter a number that is already in use, then you are prompted to select another number.

Scanning to an FTP address

Scanning to an FTP address using the printer control panel

1 Load an original document faceup, short edge first into the ADF tray or facedown on the scanner glass.

Notes:

- Do not load postcards, photos, small items, transparencies, photo paper, or thin media (such as magazine clippings) into the ADF tray. Place these items on the scanner glass.
- The ADF indicator light comes on when the paper is loaded properly.

2 If you are loading a document into the ADF tray, then adjust the paper guides.

3 From the printer control panel, navigate to:

FTP > FTP > type the FTP address > Done > Send It

Scanning to an FTP address using a shortcut number

1 Load an original document faceup, short edge first into the ADF tray or facedown on the scanner glass.

Notes:

- Do not load postcards, photos, small items, transparencies, photo paper, or thin media (such as magazine clippings) into the ADF tray. Place these items on the scanner glass.
- The ADF indicator light comes on when the paper is loaded properly.

2 If you are loading a document into the ADF tray, then adjust the paper guides.

3 From the printer control panel, press **#** on the keypad, and then enter the FTP shortcut number.



4 Touch  > **Send It**.

Scanning an FTP using the address book

1 Load an original document faceup, short edge first into the ADF tray or facedown on the scanner glass.



Notes:

- Do not load postcards, photos, small items, transparencies, photo paper, or thin media (such as magazine clippings) into the ADF tray. Place these items on the scanner glass.

- The ADF indicator light comes on when the paper is loaded properly.
- 2 If you are loading a document into the ADF tray, then adjust the paper guides.
 - 3 From the home screen, navigate to:
FTP > FTP >  > type the name of the recipient > Search
 - 4 Touch the name of the recipient.
Note: To search for additional recipients, touch **New Search**, and then type the name of the next recipient.
 - 5 Touch  > **Send It.**

Scanning to a computer or flash drive

You can use the printer to send a scanned file. You can also use Scan to Network, Multisend, and MyShortcut applications from the printer home screen. For more information, see [“Activating the home screen applications” on page 22.](#)

ADF	Scanner glass
 <p>Use the ADF for multiple-page documents.</p>	 <p>Use the scanner glass for single pages, small items (such as postcards or photos), transparencies, photo paper, or thin media (such as magazine clippings).</p>

The scanner lets you scan documents directly to a computer or a flash drive. The computer does not have to be directly connected to the printer for you to receive Scan to PC images. You can scan the document back to the computer over the network by creating a scan profile on the computer and then downloading the profile to the printer.

Scanning to a computer using the Embedded Web Server

- 1 Open a Web browser, and then type the printer IP address in the address field.
Notes:
 - View the printer IP address on the printer home screen. The IP address appears as four sets of numbers separated by periods, such as 123.123.123.123.
 - If you are using a proxy server, then temporarily disable it to load the Web page correctly.
- 2 Click **Scan Profile > Create Scan Profile.**
- 3 Select your scan settings, and then click **Next.**

4 Select a location on your computer where you want to save the scan image.

5 Type a scan name, and then a user name.

Note: The scan name is the name that appears in the Scan Profile list on the display.

6 Click **Submit**.

Note: Clicking **Submit** automatically assigns a shortcut number. You can use this shortcut number when you are ready to scan your documents.

7 Review the instructions on the Scan Profile screen.

a Load an original document faceup, short edge first into the ADF tray or facedown on the scanner glass.

Notes:

- Do not load postcards, photos, small items, transparencies, photo paper, or thin media (such as magazine clippings) into the ADF tray. Place these items on the scanner glass.
- The ADF indicator light comes on when the paper is loaded properly.

b If you are loading a document into the ADF tray, then adjust the paper guides.

c Do either of the following:

- Press #, and then enter the shortcut number using the keypad.
- From the home screen, navigate to:
Held Jobs > Profiles > select your shortcut on the list

Note: The scanner scans and sends the document to the directory you specified.

8 View the file from the computer.

Note: The output file is saved in the location or launched in the program you specified.

Setting up Scan to Computer

Notes:

- This feature is supported only in Windows Vista or later.
- Make sure your computer and printer are connected to the same network.

1 Open the printers folder, and then select your printer.

Note: If your printer is not in the list, then add your printer.

2 Open the printer properties, and then adjust the settings as necessary.

3 From the control panel, touch **Scan to Computer > select the appropriate scan setting > Send It**.

Scanning to a flash drive

1 Load an original document faceup, short edge first into the ADF tray or facedown on the scanner glass.

Notes:

- Do not load postcards, photos, small items, transparencies, photo paper, or thin media (such as magazine clippings) into the ADF tray. Place these items on the scanner glass.

- The ADF indicator light comes on when the paper is loaded properly.
- 2 If you are loading a document into the ADF tray, then adjust the paper guides.
 - 3 Insert the flash drive into the USB port on the front of the printer.
Note: The USB Drive home screen appears.
 - 4 Select the destination folder, and then touch **Scan to USB drive**.
Note: The printer goes back to the home screen after 30 seconds of inactivity.
 - 5 Adjust the scan settings, and then touch **Scan It**.

Understanding the scan options

FTP

This option lets you enter the IP address for the FTP destination.

Note: An IP address appears as four sets of numbers separated by periods, such as 123.123.123.123.

File Name

This option lets you type a file name for the scan image.

Save As Shortcut

This option lets you save the current settings as a shortcut by assigning a number.

Original Size

This option lets you set the paper size of the documents you are going to scan. When Original Size is set to Mixed Sizes, you can scan an original document that contains mixed paper sizes (letter- and legal-size pages).

Darkness

This option lets you adjust how light or dark the scanned documents are in relation to the original document.

Resolution

This option lets you adjust the output quality of your file. Increasing the image resolution increases the file size and the time needed to scan your original document. Decreasing the image resolution reduces the file size.

Send As

This option lets you set the output type for the scan image.

Select one of the following:

- **PDF**—Use to create a single file with multiple pages.
- **Secure PDF**—Use to create an encrypted PDF file that protects the file contents from unauthorized access.
- **TIFF**—Use to create multiple files or a single file. If Multi-page TIFF is turned off in the Settings menu, then TIFF saves one page in each file. The file size is usually larger than an equivalent JPEG.
- **JPEG**—Use to create and attach a separate file for each page of the original document.
- **XPS**—Use to create a single XPS file with multiple pages.

Content

This option lets you set the original document type and source.

Select from the following content types:

- **Text**—The content of the original document is mostly text or line art.
- **Text/Photo**—The original document is a mixture of text, graphics, and photos.
- **Photo**—The original document is mostly a photo or an image.
- **Graphics**—The original document is mostly business-type graphics, such as pie charts, bar charts, and animations.

Select from the following content sources:

- **Color Laser**—The original document was printed using a color laser printer.
- **Inkjet**—The original document was printed using an inkjet printer.
- **Magazine**—The original document is from a magazine.
- **Brochure**—The original document is from a brochure.
- **Black/White Laser**—The original document was printed using a mono laser printer.
- **Photo/Film**—The original document is a photo from film.
- **Newspaper**—The original document is from a newspaper.
- **Other**—The original document was printed using an alternate or unknown printer.

Page Setup

This option lets you change the following settings:

- **Sides (Duplex)**—This specifies if the original document is printed on only one side or on both sides of the paper.
- **Orientation**—This specifies the orientation of the original document, and then changes the Sides (Duplex) and Binding settings to match the orientation.
- **Binding**—This specifies if the original document is bound on the long-edge or short-edge side.

Scan Preview

This option lets you view the first page of the image before it is included in the e-mail. When the first page is scanned, the scanning is paused and a preview image appears.

Note: This option appears only when a working printer hard disk is installed.

Using the advanced options

Select from the following settings:

- **Advanced Imaging**—This adjusts the Background Removal, Color Balance, Color Dropout, Contrast, JPEG Quality, Mirror Image, Negative Image, Scan Edge to Edge, Shadow Detail, Sharpness, and Temperature settings before you scan the document.
- **Custom Job**—This combines multiple scanning jobs into a single job.
- **Edge Erase**—This removes smudges or marks around the edges of a document. You can choose to remove an equal area around all four sides of the paper, or pick a particular edge. Edge Erase erases whatever is within the area selected, leaving nothing on that portion of the scan.
- **Transmission Log**—This prints the transmission log or transmission error log.
- **Multifeed Sensor**—This detects when the ADF picks more than one sheet of paper at a time, and then shows an error message.

Note: This option is supported only in select printer models.

Understanding the printer menus

Menus list

Paper Menu

Default Source
 Paper Size/Type
 Configure MP
 Substitute Size
 Paper Texture
 Paper Weight
 Paper Loading
 Custom Types
 Custom Names¹
 Custom Scan Sizes
 Universal Setup

Reports

Menu Settings Page
 Device Statistics
 Stapler Test
 Network Setup Page¹
 Network [x] Setup Page
 Shortcut List
 Fax Job Log
 Fax Call Log
 Copy Shortcuts
 E-mail Shortcuts
 Fax Shortcuts
 FTP Shortcuts
 Profiles List
 Print Fonts
 Print Directory
 Print Demo
 Asset Report

Network/Ports

Active NIC
 Standard Network²
 Standard USB
 Parallel [x]
 Serial [x]
 SMTP Setup

Security

Edit Security Settings
 Miscellaneous Security
 Settings
 Confidential Print Menu
 Erase Temporary Data
 Files
 Security Audit Log
 Set Date and Time

Settings

General Settings
 Copy Settings
 Fax Settings
 E-mail Settings
 FTP Settings
 Flash Drive Menu
 Print Settings

Help

Print All Guides
 Copy Guide
 E-mail Guide
 Fax Guide
 FTP Guide
 Print Defects Guide
 Information Guide
 Supplies Guide

Manage Shortcuts

Fax Shortcuts
 E-mail Shortcuts
 FTP Shortcuts
 Copy Shortcuts
 Profile Shortcuts

Option Card Menu³

A list of installed DLEs (Download Emulators) appears.

¹ Depending on the printer setup, this menu appears as Network Setup Page or Network [x] Setup Page.

² Depending on the printer setup, this menu appears as Standard Network or Network [x].

³ This menu appears only when one or more DLEs are installed.

Paper menu

Default Source menu

Use	To
Default Source Tray [x] Multipurpose Feeder Manual Paper Manual Envelope	Set a default paper source for all print jobs. Notes: <ul style="list-style-type: none"> • Tray 1 (standard tray) is the factory default setting. • From the Paper menu, set Configure MP to "Cassette" for Multipurpose Feeder to appear as a menu setting. • If two trays contain paper of the same size and type, and the trays have the same settings, then the trays are automatically linked. When one tray is empty, the print job continues using the linked tray.

Paper Size/Type menu

Use	To
Tray [x] Size A4 A5 A6 JIS-B5 Letter Legal Executive Oficio (Mexico) Folio Statement Universal 7 3/4 Envelope 9 Envelope 10 Envelope DL Envelope C5 Envelope B5 Envelope Other Envelope	Specify the paper size loaded in each tray. Notes: <ul style="list-style-type: none"> • Letter is the U.S. factory default setting. A4 is the international factory default setting. • If two trays contain paper of the same size and type, and the trays have the same settings, then the trays are automatically linked. The multipurpose feeder may also be linked. When one tray is empty, the print job continues using the linked tray. • The A6 paper size is supported only in Tray 1 and the multipurpose feeder.
Note: Only installed trays and feeders are listed in this menu.	

Use	To
<p>Tray [x] Type</p> <ul style="list-style-type: none"> Plain Paper Card Stock Transparency Recycled Labels Vinyl Labels Bond Envelope Rough Envelope Letterhead Preprinted Colored Paper Light Paper Heavy Paper Rough/Cotton Custom Type [x] 	<p>Specify the type of paper loaded in each tray.</p> <p>Notes:</p> <ul style="list-style-type: none"> • Plain Paper is the factory default setting for Tray 1. Custom Type [x] is the factory default setting for all other trays. • If available, a user-defined name will appear instead of Custom Type [x]. • Use this menu to configure automatic tray linking.
<p>Multipurpose Feeder Size</p> <ul style="list-style-type: none"> A4 A5 A6 JIS B5 Letter Legal Executive Oficio (Mexico) Folio Statement Universal 7 3/4 Envelope 9 Envelope 10 Envelope DL Envelope C5 Envelope B5 Envelope Other Envelope 	<p>Specify the paper size loaded in the multipurpose feeder.</p> <p>Notes:</p> <ul style="list-style-type: none"> • Letter is the U.S. factory default setting. A4 is the international factory default setting. • From the Paper menu, set Configure MP to “Cassette” for Multipurpose Feeder Size to appear as a menu. • The multipurpose feeder does not automatically detect paper size. Make sure to set the paper size value.
<p>Note: Only installed trays and feeders are listed in this menu.</p>	

Use	To
<p>Multipurpose Feeder Type</p> <ul style="list-style-type: none"> Plain Paper Card Stock Transparency Recycled Labels Vinyl Labels Bond Envelope Rough Envelope Letterhead Preprinted Colored Paper Light Paper Heavy Paper Rough/Cotton Custom Type [x] 	<p>Specify the paper type loaded in the multipurpose feeder.</p> <p>Notes:</p> <ul style="list-style-type: none"> • Plain Paper is the factory default setting. • From the Paper menu, set Configure to “Cassette” for Multipurpose Feeder Type to appear as a menu.
<p>Manual Paper Size</p> <ul style="list-style-type: none"> A4 A5 A6 JIS B5 Letter Legal Executive Oficio (Mexico) Folio Statement Universal 	<p>Specify the size of the paper being manually loaded.</p> <p>Note: Letter is the U.S. factory default setting. A4 is the international factory default setting.</p>
<p>Note: Only installed trays and feeders are listed in this menu.</p>	

Use	To
<p>Manual Paper Type</p> <ul style="list-style-type: none"> Plain Paper Card Stock Transparency Recycled Labels Vinyl Labels Bond Letterhead Preprinted Colored Paper Light Paper Heavy Paper Rough/Cotton Custom Type [x] 	<p>Specify the paper type being manually loaded.</p> <p>Notes:</p> <ul style="list-style-type: none"> • Plain Paper is the factory default setting. • From the Paper menu, set Configure MP to “Manual” for Manual Paper Type to appear as a menu.
<p>Manual Envelope Size</p> <ul style="list-style-type: none"> 7 3/4 Envelope 9 Envelope 10 Envelope DL Envelope C5 Envelope B5 Envelope Other Envelope 	<p>Specify the envelope size being manually loaded.</p> <p>Note: 10 Envelope is the U.S. factory default setting. DL Envelope is the international factory default setting.</p>
<p>Manual Envelope Type</p> <ul style="list-style-type: none"> Envelope Rough Envelope Custom Type [x] 	<p>Specify the envelope type being manually loaded.</p> <p>Note: Envelope is the factory default setting.</p>
<p>Note: Only installed trays and feeders are listed in this menu.</p>	

Configure MP menu

Use	To
<p>Configure MP</p> <ul style="list-style-type: none"> Cassette Manual First 	<p>Determine when the printer selects paper from the multipurpose feeder.</p> <p>Notes:</p> <ul style="list-style-type: none"> • Cassette is the factory default setting. Cassette configures the multipurpose feeder as the automatic paper source. • Manual sets the multipurpose feeder only for manual-feed print jobs. • First configures the multipurpose feeder as the primary paper source.

Substitute Size menu

Use	To
Substitute Size Off Statement/A5 Letter/A4 All Listed	Substitute a specified paper size if the requested paper size is not available. Notes: <ul style="list-style-type: none"> • All Listed is the factory default setting. All available substitutions are allowed. • Off indicates no size substitutions are allowed. • Setting a substitution lets the job print without a Change Paper message appearing.

Paper Texture menu

Use	To
Plain Texture Smooth Normal Rough	Specify the relative texture of the plain paper loaded. Note: Normal is the factory default setting.
Card Stock Texture Smooth Normal Rough	Specify the relative texture of the card stock loaded. Notes: <ul style="list-style-type: none"> • Normal is the factory default setting. • The options appear only if card stock is supported.
Transparency Texture Smooth Normal Rough	Specify the relative texture of the transparencies loaded. Note: Normal is the factory default setting.
Recycled Texture Smooth Normal Rough	Specify the relative texture of the recycled paper loaded. Note: Normal is the factory default setting.
Labels Texture Smooth Normal Rough	Specify the relative texture of the labels loaded. Note: Normal is the factory default setting.
Bond Texture Smooth Normal Rough	Specify the relative texture of the bond paper loaded. Note: Rough is the factory default setting.
Envelope Texture Smooth Normal Rough	Specify the relative texture of the envelopes loaded. Note: Normal is the factory default setting.

Use	To
Rough Envelope Texture Rough	Specify the relative texture of the rough envelopes loaded.
Letterhead Texture Smooth Normal Rough	Specify the relative texture of the letterhead loaded. Note: Normal is the factory default setting.
Preprinted Texture Smooth Normal Rough	Specify the relative texture of the preprinted paper loaded. Note: Normal is the factory default setting.
Colored Texture Smooth Normal Rough	Specify the relative texture of the colored paper loaded. Note: Normal is the factory default setting.
Light Texture Smooth Normal Rough	Specify the relative texture of the paper loaded. Note: Normal is the factory default setting.
Heavy Texture Smooth Normal Rough	Specify the relative texture of the paper loaded. Note: Normal is the factory default setting.
Rough/Cotton Texture Rough	Specify the relative texture of the cotton paper loaded.
Custom [x] Texture Smooth Normal Rough	Specify the relative texture of the custom paper loaded. Notes: <ul style="list-style-type: none"> • Normal is the factory default setting. • The options appear only if the custom type is supported.

Paper Weight menu

Use	To
Plain Weight Light Normal Heavy	Specify the relative weight of the plain paper loaded. Note: Normal is the factory default setting.
Card Stock Weight Light Normal Heavy	Specify the relative weight of the card stock loaded. Note: Normal is the factory default setting.

Use	To
Transparency Weight Light Normal Heavy	Specify the relative weight of the transparencies loaded. Note: Normal is the factory default setting.
Recycled Weight Light Normal Heavy	Specify the relative weight of the recycled paper loaded. Note: Normal is the factory default setting.
Labels Weight Light Normal Heavy	Specify the relative weight of the labels loaded. Note: Normal is the factory default setting.
Bond Weight Light Normal Heavy	Specify the relative weight of the bond paper loaded. Note: Normal is the factory default setting.
Envelope Weight Light Normal Heavy	Specify the relative weight of the envelope loaded. Note: Normal is the factory default setting.
Rough Envelope Weight Light Normal Heavy	Specify the relative weight of the rough envelope loaded. Note: Normal is the factory default setting.
Letterhead Weight Light Normal Heavy	Specify the relative weight of the letterhead loaded. Note: Normal is the factory default setting.
Preprinted Weight Light Normal Heavy	Specify the relative weight of the preprinted paper loaded. Note: Normal is the factory default setting.
Colored Weight Light Normal Heavy	Specify the relative weight of the colored paper loaded. Note: Normal is the factory default setting.
Light Weight Light	Specify that the relative weight of the paper loaded is light.
Heavy Weight Heavy	Specify the relative weight of the paper loaded is heavy.

Use	To
Rough/Cotton Weight Light Normal Heavy	Specify the relative weight of the cotton or rough paper loaded. Note: Normal is the factory default setting.
Custom [x] Weight Light Normal Heavy	Specify the relative weight of the custom paper loaded. Notes: <ul style="list-style-type: none"> • Normal is the factory default setting. • The options appear only when the custom type is supported.

Paper Loading menu

Use	To
Card Stock Loading Duplex Off	Determine and set two-sided printing for all print jobs that specify Card Stock as the paper type.
Recycled Loading Duplex Off	Determine and set two-sided printing for all print jobs that specify Recycled as the paper type.
Labels Loading Duplex Off	Determine and set two-sided printing for all print jobs that specify Labels as the paper type.
Bond Loading Duplex Off	Determine and set two-sided printing for all print jobs that specify Bond as the paper type.
Letterhead Loading Duplex Off	Determine and set two-sided printing for all print jobs that specify Letterhead as the paper type.
Preprinted Loading Duplex Off	Determine and set two-sided printing for all print jobs that specify Preprinted as the paper type.
Colored Loading Duplex Off	Determine and set two-sided printing for all print jobs that specify Colored as the paper type.
Light Loading Duplex Off	Determine and set two-sided printing for all print jobs that specify Light as the paper type.
Notes: <ul style="list-style-type: none"> • Off is the factory default setting for all Paper Loading menu selections. • Duplex sets the printer default to two-sided printing for every print job unless one-sided printing is selected from Print Preferences in Windows or the Print dialog in Macintosh. 	

Use	To
Heavy Loading Duplex Off	Determine and set two-sided printing for all print jobs that specify Heavy as the paper type.
Rough/Cotton Loading Duplex Off	Determine and set two-sided printing for all print jobs that specify Rough or Cotton as the paper type.
Custom [x] Loading Duplex Off	Determine and set two-sided printing for all print jobs that specify Custom [x] as the paper type. Note: Custom [x] Loading appears only when the custom type is supported.
Notes: <ul style="list-style-type: none"> • Off is the factory default setting for all Paper Loading menu selections. • Duplex sets the printer default to two-sided printing for every print job unless one-sided printing is selected from Print Preferences in Windows or the Print dialog in Macintosh. 	

Custom Types menu

Use	To
Custom Type [x] Paper Card Stock Transparency Rough/Cotton Labels Envelope	Associate a paper or specialty media type with a factory default custom type name or a user-defined custom name created from the Embedded Web Server.
Recycled Paper Card Stock Transparency Rough/Cotton Labels Envelope	Specify a paper type when Recycled is selected in other menus.
Notes: <ul style="list-style-type: none"> • Paper is the factory default setting. • The custom media type must be supported by the selected tray or multipurpose feeder to print from that source. 	

Custom Names menu

Use	To
Custom Name [x]	Specify a custom name for a paper type. This name replaces Custom Type [x] in the printer menus.

Custom Scan Sizes menu

Use	To
Custom Scan Size [x] Scan Size Name Width Height Orientation Portrait Landscape 2 scans per side Off On	Specify a custom scan size name and page orientation. Notes: <ul style="list-style-type: none"> • The custom scan size name replaces Custom Scan Size [x] in the printer menus. • ADF Media Type is the factory default setting for custom scan sizes 3, 4, 5, and 6. • 8.5 inches is the U.S. factory default setting for Width. 210 millimeters is the international factory default setting for Width. • 14 inches is the U.S. factory default setting for Height. 297 millimeters is the international factory default setting for Height. • Portrait is the factory default setting for Orientation. • Off is the factory default setting for “2 scans per side.”

Universal Setup menu

Use	To
Units of Measure Inches Millimeters	Identify the units of measure. Notes: <ul style="list-style-type: none"> • Inches is the U.S. factory default setting. • Millimeters is the international factory default setting.
Portrait Width 3–14.17 inches 76–360 mm	Set the portrait width. Notes: <ul style="list-style-type: none"> • If the width exceeds the maximum, then the printer uses the maximum width allowed. • 8.5 inches is the U.S. factory default setting. You can increase the width in 0.01-inch increments. • 216 mm is the international factory default setting. You can increase the width in 1-mm increments.
Portrait Height 3–14.17 inches 76–360 mm	Set the portrait height. Notes: <ul style="list-style-type: none"> • If the height exceeds the maximum, then the printer uses the maximum height allowed. • 14 inches is the U.S. factory default setting. You can increase the height in 0.01-inch increments. • 356 mm is the international factory default setting. You can increase the height in 1-mm increments.

Use	To
Feed Direction Short Edge Long Edge	Specify the feed direction if the paper can be loaded in either direction. Notes: <ul style="list-style-type: none"> • Short Edge is the factory default setting. • Long Edge appears only when the longest edge is shorter than the maximum width supported in the tray.

Reports Menu

Reports menu

Use	To
Menu Settings Page	Print a report containing information about the paper loaded in trays, installed memory, total page count, alarm settings, timeouts, printer control panel language, TCP/IP address, status of supplies, status of the network connection, and other information.
Device Statistics	Print a report containing printer statistics such as supply information and number of printed pages.
Network Setup Page	Print a report containing information about the network printer settings, such as the TCP/IP address information. Note: This menu item appears only in network printers or in printers connected to print servers.
Network [x] Setup Page	Print a report containing information about the network settings of the printer, such as the TCP/IP address information. Note: This menu item appears only in network printers or printers connected to print servers, and when there is more than one network option installed.
Shortcut List	Print a report containing information about configured shortcuts.
Fax Job Log	Print a report containing information about the last 200 completed faxes. Note: This menu item appears only when Enable Job Log is set to On in the Fax Settings menu.
Fax Call Log	Print a report containing information about the last 100 attempted, received, and blocked calls. Note: This menu item appears only when Enable Job Log is set to On in the Fax Settings menu.
Copy Shortcuts	Print a report containing information about copy shortcuts.
E-mail Shortcuts	Print a report containing information about e-mail shortcuts.
Fax Shortcuts	Print a report containing information about fax shortcuts.
FTP Shortcuts	Print a report containing information about FTP shortcuts.
Profiles List	Print a list of profiles stored in the printer.
Print Fonts	Print a report of all the fonts available for the printer language currently set in the printer.

Use	To
Print Directory	<p>Print a list of all the resources stored in an optional flash memory card or printer hard disk.</p> <p>Notes:</p> <ul style="list-style-type: none"> • Job Buffer Size must be set to 100%. • Make sure the optional flash memory or printer hard disk is working and installed correctly.
Asset Report	<p>Print a report containing asset information including the printer serial number and model name. The report contains text and UPC bar codes that can be scanned into an asset database.</p>

Network/Ports menu

Active NIC menu

Use	To
Active NIC Auto [list of available network cards]	<p>Notes:</p> <ul style="list-style-type: none"> • Auto is the factory default setting. • This menu item appears only when an optional network card is installed.

Standard Network or Network [x] menu

Note: Only active ports appear in this menu. All inactive ports are omitted.

Use	To
PCL SmartSwitch On Off	<p>Set the printer to automatically switch to PCL emulation when a print job requires it, regardless of the default printer language.</p> <p>Notes:</p> <ul style="list-style-type: none"> • On is the factory default setting. • If PCL SmartSwitch is disabled, then the printer does not examine incoming data and it uses the default printer language specified in the Setup menu.
PS SmartSwitch On Off	<p>Set the printer to automatically switch to PS emulation when a print job requires it, regardless of the default printer language.</p> <p>Notes:</p> <ul style="list-style-type: none"> • On is the factory default setting. • If PS SmartSwitch is disabled, then the printer does not examine incoming data and uses the default printer language specified in the Setup menu.

Use	To
NPA Mode Off Auto	Set the printer to perform the special processing required for bidirectional communication following the conventions defined by the NPA protocol. Notes: <ul style="list-style-type: none"> • Auto is the factory default setting. • Changing this setting from the printer control panel and then exiting the menus causes the printer to restart. The menu selection is then updated.
Network Buffer Auto 3KB to [maximum size allowed]	Set the size of the network input buffer. Notes: <ul style="list-style-type: none"> • Auto is the factory default setting. • The value can be changed in 1KB increments. • The maximum size allowed depends on the amount of memory in the printer, the size of the other link buffers, and whether Resource Save is set to On or Off. • To increase the maximum size range for the Network Buffer, disable or reduce the size of the parallel, serial, and USB buffers. • Changing this setting from the printer control panel, and then exiting the menus causes the printer to restart. The menu selection is then updated.
Mac Binary PS On Off Auto	Set the printer to process Macintosh binary PostScript print jobs. Notes: <ul style="list-style-type: none"> • Auto is the factory default setting. • Off filters print jobs using the standard protocol. • On processes raw binary PostScript print jobs.
Standard Network Setup or Network [x] Setup Reports Network Card TCP/IP IPv6 Wireless AppleTalk	Display and set the printer network settings. Note: The Wireless menu appears only when the printer is connected to a wireless network.

Reports menu

To access the menu, navigate to either of the following:

- **Network/Ports > Standard Network > Standard Network Setup > Reports**
- **Network/Ports > Network [x] > Network [x] Setup > Reports**

Use	To
Print Setup Page	Print a report containing information about the network printer settings, such as the TCP/IP address.

Network Card menu

To access the menu, navigate to either of the following:

- **Network/Ports > Standard Network > Standard Network Setup > Network Card**
- **Network/Ports > Network [x] > Network [x] Setup > Network Card**

Use	To
View Card Status Connected Disconnected	View the connection status of the network card.
View Card Speed	View the speed of an active network card.
Network Address UAA LAA	View the network addresses.
Job Timeout 0–255 seconds	Set the amount of time it takes for a network print job to be canceled. Notes: <ul style="list-style-type: none"> • 90 seconds is the factory default setting. • A setting value of 0 disables the timeout. • If a value of 1–9 is selected, then the setting is saved as 10.

TCP/IP menu

To access the menu, navigate to either of the following:

- **Network/Ports > Standard Network > Standard Network Setup > TCP/IP**
- **Network/Ports > Network [x] > Network [x] Setup > TCP/IP**

Note: This menu is available only in network printers or printers attached to print servers.

Use	To
Set Hostname	Set the current TCP/IP host name. Note: This can be changed only from the Embedded Web Server.
IP Address	View or change the current TCP/IP address. Note: Manually setting the IP address sets the Enable DHCP and Enable Auto IP settings to Off. It also sets Enable BOOTP and Enable RARP to Off on systems that support BOOTP and RARP.
Netmask	View or change the current TCP/IP netmask.
Gateway	View or change the current TCP/IP gateway.
Enable DHCP On Off	Specify the DHCP address and parameter assignment. Note: On is the factory default setting.
Enable RARP On Off	Specify the RARP address assignment setting. Note: Off is the factory default setting.

Use	To
Enable BOOTP On Off	Specify the BOOTP address assignment setting. Note: On is the factory default setting.
Enable AutoIP Yes No	Specify the Zero Configuration Networking setting. Note: Yes is the factory default setting.
Enable FTP/TFTP Yes No	Enable the built-in FTP server, which lets you send files to the printer using File Transfer Protocol. Note: Yes is the factory default setting.
Enable HTTP Server Yes No	Enable the built-in Web server (Embedded Web Server). When enabled, the printer can be monitored and managed remotely using a Web browser. Note: Yes is the factory default setting.
WINS Server Address	View or change the current WINS server address.
Enable DDNS Yes No	View or change the current DDNS setting. Note: Yes is the factory default setting.
Enable mDNS Yes No	View or change the current mDNS setting. Note: Yes is the factory default setting.
DNS Server Address	View or change the current DNS server address.
Backup DNS Server Address	View or change the backup DNS server addresses.
Backup DNS Server Address 2	
Backup DNS Server Address 3	
Enable HTTPS Yes No	View or change the current HTTPS setting. Note: Yes is the factory default setting.

IPv6 menu

To access the menu, navigate to either of the following:

- **Network/Ports > Standard Network > Standard Network Setup > IPv6**
- **Network/Ports > Network [x] > Network [x] Setup > IPv6**

Note: This menu is available only in network printers or printers that are attached to print servers.

Use	To
Enable IPv6 On Off	Enable IPv6 in the printer. Note: On is the factory default setting.

Use	To
Auto Configuration On Off	Specify whether or not the wireless network adapter accepts the automatic IPv6 address configuration entries provided by a router. Note: On is the factory default setting.
View Hostname	Set the host name.
View Address	Note: These settings can be changed only from the Embedded Web Server.
View Router Address	
Enable DHCPv6 On Off	Enable DHCPv6 in the printer. Note: On is the factory default setting.

Wireless menu

Note: This menu is available only in printers connected to an Ethernet network and printers with a wireless network adapter attached.

To access the menu, navigate to either of the following:

- **Network/Ports > Standard Network > Standard Network Setup > Wireless**
- **Network/Ports > Network [x] > Network [x] Setup > Wireless**

Use	To
Wi-Fi Protected Setup (WPS) Start Push Button Method Start PIN Method	Establish a wireless network connection and enable network security. Notes: <ul style="list-style-type: none"> • Start Push Button Method connects the printer to a wireless network when buttons on both the printer and the access point (wireless router) are pressed within a given period of time. • Start PIN Method connects the printer to a wireless network when a PIN on the printer is entered into the wireless settings of the access point.
Enable/Disable WPS Auto-detection Enable Disable	Automatically detect the connection method that an access point with WPS uses—Start Push Button Method or Start PIN Method. Note: Disable is the factory default setting.
Network Mode BSS Type Infrastructure Ad hoc	Specify the network mode. Notes: <ul style="list-style-type: none"> • Infrastructure is the factory default setting. This lets the printer access a network using an access point. • Ad hoc configures a wireless connection directly between the printer and a computer.
Compatibility 802.11b/g 802.11b/g/n	Specify the wireless standard for the wireless network. Note: The 802.11b/g/n is the factory default setting.
Choose Network	Select an available network for the printer to use.
View Signal Quality	View the quality of the wireless connection.

Use	To
View Security Mode	View the encryption method for the wireless network.

AppleTalk menu

Note: This menu appears only in printer models that are connected to an Ethernet network or when an optional wireless network adapter is installed.

To access the menu, navigate to either of the following:

- **Network/Ports > Standard Network > Standard Network Setup > AppleTalk**
- **Network/Ports > Network [x] > Network [x] Setup > AppleTalk**

Use	To
Activate Yes No	Enable or disable AppleTalk support. Note: Yes is the factory default setting.
View Name	Show the assigned AppleTalk name. Note: The AppleTalk name can be changed only from the Embedded Web Server.
View Address	Show the assigned AppleTalk address. Note: The AppleTalk address can be changed only from the Embedded Web Server.
Set Zone [list of zones available on the network]	Provide a list of AppleTalk zones available on the network. Note: The default zone for the network is the factory default setting.

Standard USB menu

Use	To
PCL SmartSwitch On Off	Set the printer to automatically switch to PCL emulation when a print job received through a USB port requires it, regardless of the default printer language. Notes: <ul style="list-style-type: none"> • On is the factory default setting. • When set to Off, the printer does not examine incoming data. The printer uses PostScript emulation if the PS SmartSwitch is set to On. It uses the default printer language specified in the Setup menu if the PS SmartSwitch is set to Off.
PS SmartSwitch On Off	Set the printer to automatically switch to PS emulation when a print job received through a USB port requires it, regardless of the default printer language. Notes: <ul style="list-style-type: none"> • On is the factory default setting. • When set to Off, the printer does not examine incoming data. The printer uses PCL emulation if the PCL SmartSwitch is set to On. It uses the default printer language specified in the Setup menu if the PCL SmartSwitch is set to Off.

Use	To
NPA Mode On Off Auto	Set the printer to perform the special processing required for bidirectional communication following the conventions defined by the NPA protocol. Notes: <ul style="list-style-type: none"> • Auto is the factory default setting. Auto sets the printer to examine data, determine the format, and then process it appropriately. • The printer automatically restarts when changing the setting from the printer control panel. The menu selection is then updated.
USB Buffer Disabled Auto 3K to [maximum size allowed]	Set the size of the USB input buffer. Notes: <ul style="list-style-type: none"> • Auto is the factory default setting. • Disabled turns off job buffering. Any jobs already buffered on the printer hard disk are printed before normal processing resumes. • The USB buffer size value can be changed in 1-K increments. • The maximum size allowed depends on the amount of memory in the printer, the size of the other link buffers, and whether Resource Save is set to On or Off. • To increase the maximum size range for the USB Buffer, disable or reduce the size of the parallel, serial, and network buffers. • The printer automatically restarts when the setting is changed from the printer control panel. The menu selection is then updated.
Job Buffering Off On Auto	Temporarily store print jobs in the printer hard disk before printing. Notes: <ul style="list-style-type: none"> • Off is the factory default setting. • On buffers jobs on the printer hard disk. • Auto buffers print jobs only if the printer is busy processing data from another input port. • Changing this setting from the printer control panel and then exiting the menus causes the printer to restart. The menu selection is then updated.
Mac Binary PS On Off Auto	Set the printer to process Macintosh binary PostScript print jobs. Notes: <ul style="list-style-type: none"> • Auto is the factory default setting. • On processes raw binary PostScript print jobs. • Off filters print jobs using the standard protocol.
ENA Address YYY.YYY.YYY.YYY	Set the network address information for an external print server. Note: This menu is available only when the printer is attached to an external print server through the USB port.
ENA Netmask YYY.YYY.YYY.YYY	Set the netmask information for an external print server. Note: This menu is available only when the printer is attached to an external print server through the USB port.

Use	To
ENA Gateway YYY.YYY.YYY.YYY	Set the gateway information for an external print server. Note: This menu is available only when the printer is attached to an external print server through the USB port.

SMTP Setup menu

Use	To
Primary SMTP Gateway	Specify SMTP server gateway and port information. Note: 25 is the default SMTP gateway port.
Primary SMTP Gateway Port	
Secondary SMTP Gateway	
Secondary SMTP Gateway Port	
SMTP Timeout 5–30	Specify the amount of time in seconds before the server stops trying to send an e-mail. Note: 30 is the factory default setting.
Reply Address	Specify a reply address of up to 128 characters in the e-mail sent by the printer.
Use SSL Disabled Negotiate Required	Set the printer to use SSL for increased security when connecting to the SMTP server. Notes: <ul style="list-style-type: none"> Disabled is the factory default setting. When the Negotiate setting is used, the SMTP server determines if SSL will be used.
SMTP Server Authentication No authentication required Login/Plain CRAM-MD5 Digest-MD5 NTLM Kerberos 5	Specify the type of user authentication required for scan to e-mail privileges. Note: “No authentication required” is the factory default setting.

Use	To
Device-Initiated E-mail None Use Device SMTP Credentials	Specify what credentials will be used when communicating to the SMTP server. Notes: <ul style="list-style-type: none"> • None is the factory default setting for Device-Initiated E-mail and User-Initiated E-mail. • “Device Userid” and “Device password” are used to log in to the SMTP server when Use Device SMTP Credentials is selected.
User-Initiated E-mail None Use Device SMTP Credentials Use Session User ID and Password Use Session E-mail address and Password Prompt user	
Device Userid	
Device password	
Kerberos 5 Realm	
NTLM Domain	

Security menu

Edit Security Setups menu

Note: This menu appears only in select touch-screen printer models.

Use	To
Edit Backup Password Use Backup Password <ul style="list-style-type: none"> • Off • On Password	Create a backup password. Notes: <ul style="list-style-type: none"> • Off is the factory default setting for “Use Backup Password.” • This menu appears only if a backup password exists.
Edit Building Blocks Internal Accounts NTLM Simple Kerberos Setup Kerberos Setup Active Directory LDAP LDAP+GSSAPI Password PIN	Edit settings for Internal Accounts, NTLM, Simple Kerberos Setup, Kerberos Setup, Active Directory, LDAP, Password, and PIN.
Edit Security Templates [list of available templates]	Add or edit a security template.

Use	To
<p>Edit Access Controls</p> <ul style="list-style-type: none"> Administrative Menus Function Access Management Solutions Cancel jobs at the Device 	<p>Control access to printer menus, firmware updates, held jobs, and other access points.</p>

Miscellaneous Security Settings menu

Use	To
<p>Login Restrictions</p> <ul style="list-style-type: none"> Login failures Failure time frame Lockout time Panel Login Timeout Remote Login Timeout 	<p>Limit the number and time frames of failed login attempts from the printer control panel before all users are locked out.</p> <p>Notes:</p> <ul style="list-style-type: none"> • “Login failures” specifies the number of failed login attempts before users are locked out. Settings range from 1 to 10 attempts is the factory default setting. • “Failure time frame” specifies the time frame during which failed login attempts can be made before users are locked out. Settings range from 1 to 60 minutes. 5 minutes is the factory default setting. • “Lockout time” specifies how long users are locked out after exceeding the login failures limit. Settings range from 1 to 60 minutes. 5 minutes is the factory default setting. 1 indicates the printer does not impose a lockout time. • “Panel Login Timeout” specifies how long the printer remains idle on the Home screen before automatically logging the user off. Settings range from 1 to 900 seconds. 30 seconds is the factory default setting. • “Remote Login Timeout” specifies how long a remote interface remains idle before automatically logging the user off. Settings range from 1 to 120 seconds. 10 minutes is the factory default setting.
<p>Security Reset Jumper</p> <ul style="list-style-type: none"> Access controls=“No Security” No Effect Reset factory security defaults 	<p>Change the value of the security settings.</p> <p>Notes:</p> <ul style="list-style-type: none"> • Access controls=“No Security” retains all the security information that the user has defined. “No Security” is the factory default setting. • “No Effect” means the reset has no effect on the device’s security configuration. • “Reset factory security defaults” deletes all security information that the user has defined, and assigns the factory default value to each setting in the Miscellaneous Security Settings section of both the panel and the Embedded Web Server.

Use	To
LDAP Certificate Verification Demand Try Allow Never	Allow the user to request a server certificate. Notes: <ul style="list-style-type: none"> • “Demand” means a server certificate is requested. If a bad certificate is provided or if no certificate is provided, then the session is terminated immediately. “Demand” is the factory default setting. • “Try” means a server certificate is requested. If no certificate is provided, then the session proceeds normally. If a bad certificate is provided, then the session is terminated immediately. • “Allow” means a server certificate is requested. If no certificate is provided, then the session proceeds normally. If a bad certificate is provided, then it will be ignored, and then the session proceeds normally. • “Never” means no server certificate is requested.
Minimum PIN Length 1–16	Limit the digit length of the PIN. Note: 4 is the is the factory default setting.

Confidential Print menu

Use	To
Max Invalid PIN Off 2–10	Set a limit on the number of times an invalid PIN can be entered. Notes: <ul style="list-style-type: none"> • This menu item appears only when a formatted, working printer hard disk is installed. • When the limit is reached, the print jobs for that user name and PIN are deleted.
Confidential Job Expiration Off 1 hour 4 hours 24 hours 1 week	Set a limit on how long the printer stores confidential print jobs. Notes: <ul style="list-style-type: none"> • If the “Confidential Job Expiration” setting is changed while confidential print jobs reside in the printer memory or printer hard disk, then the expiration time for those print jobs does not change to the new default value. • If the printer is turned off, then all confidential jobs held in the printer memory are deleted.
Repeat Job Expiration Off 1 hour 4 hours 24 hours 1 week	Set a limit on how long the printer stores print jobs.
Note: Off is the factory default setting.	

Use	To
Verify Job Expiration Off 1 hour 4 hours 24 hours 1 week	Set a limit on how long the printer stores print jobs needing verification.
Reserve Job Expiration Off 1 hour 4 hours 24 hours 1 week	Set a limit on how long the printer stores print jobs for printing at a later time.
Note: Off is the factory default setting.	

Erase Temporary Data Files menu

Erase Temporary Data Files deletes *only* print job data on the printer hard disk that *are not* currently in use by the file system. All permanent data on the printer hard disk are preserved, such as downloaded fonts, macros, and held jobs.

Note: This menu appears only when a formatted, working printer hard disk is installed.

Use	To
Wiping Mode Auto	Specify the mode for erasing temporary data files.
Automatic Method Single pass Multiple pass	Mark all disk space used by a previous print job. This method does not permit the file system to reuse this space until it has been cleared. Notes: <ul style="list-style-type: none"> • “Single pass” is the factory default setting. • Only automatic wiping enables users to erase temporary data files without having to turn off the printer for an extended amount of time. • Highly confidential information should be erased using <i>only</i> the Multiple pass method.

Security Audit Log menu

Use	To
Export Log	Let an authorized user export the audit log. Notes: <ul style="list-style-type: none"> • To export the audit log from the printer control panel, a flash drive must be attached to the printer. • The audit log can be downloaded from the Embedded Web Server and saved on a computer.

Use	To
Delete Log Yes No	Specify whether or not audit logs are deleted. Note: Yes is the factory default setting.
Configure Log Enable Audit Yes No Enable Remote Syslog No Yes Remote Syslog Facility 0–23 Severity of events to log 0–7	Specify how and whether or not audit logs are created. Notes: <ul style="list-style-type: none"> • Enable Audit determines if events are recorded in the secure audit log and remote syslog. No is the factory default setting. • Enable Remote Syslog determines if logs are sent to a remote server. No is the factory default setting. • Remote Syslog Facility determines the value used to send logs to the remote syslog server. 4 is the factory default setting. • If the security audit log is activated, then the severity value of each event is recorded. 4 is the factory default setting.

Set Date/Time menu

Use	To
Current Date and Time	View the current date and time settings for the printer.
Manually Set Date and Time	Enter the date and time. Note: Date/Time is set in YYYY-MM-DD HH:MM:SS format.
Time Zone	Select the time zone. Note: GMT is the factory default setting.
Automatically Observe DST On Off	Set the printer to use the applicable daylight saving time (DST) start and end times associated with the printer Time Zone setting. Note: On is the factory default setting and uses the applicable Daylight Saving Time associated with the Time Zone setting.
Custom Time Zone Setup DST Start Week DST Start Day DST Start Month DST Start Time DST End Week DST End Day DST End Month DST End Time DST Offset	Enable the user to set up the time zone.
Enable NTP On Off	Enable Network Time Protocol, which synchronizes the clocks of devices on a network. Note: On is the factory default setting.
NTP Server	View the NTP server address.

Use	To
Enable Authentication On Off	Change the authentication setting to On or Off. Note: Off is the factory default setting.

Settings menu

General Settings menu

Use	To
Display Language English Francais Deutsch Italiano Espanol Dansk Norsk Nederlands Svenska Portuguese Suomi Russian Polski Greek Magyar Turkce Cesky Simplified Chinese Traditional Chinese Korean Japanese	Set the language of the text appearing on the display. Note: Not all languages are available for all models. You may need to install special hardware for some languages.
Show Supply Estimates Show estimates Do not show estimates	View the estimates of the supplies on the control panel, Embedded Web Server, menu settings, and device statistics reports. Note: Show estimates is the factory default setting.

Use	To
Eco-Mode Off Energy Energy/Paper Paper	Minimize the use of energy, paper, or specialty media. Notes: <ul style="list-style-type: none">• Off is the factory default setting. This resets the printer to its factory default settings.• Energy minimizes the power used by the printer.• Energy/Paper minimizes the use of power, paper, and specialty media.• Paper minimizes the amount of paper and specialty media needed for a print job.
ADF Loaded Beep Enabled Disabled	Specify whether the ADF sounds a beep when paper is loaded. Note: Enabled is the factory default setting.
Quiet Mode Off On	Minimize the printer noise. Note: Off is the factory default setting.
Run Initial setup Yes No	Run the setup wizard.

Use	To
<p>Keyboard</p> <ul style="list-style-type: none"> Keyboard Type <ul style="list-style-type: none"> English Francais Francais Canadien Deutsch Italiano Espanol Greek Dansk Norsk Nederlands Svenska Suomi Portuguese Russian Polski Swiss German Swiss French Korean Magyar Turkce Cesky Simplified Chinese Traditional Chinese Japanese Custom Key [x] 	<p>Specify a language and custom key information for the display keyboard.</p>
<p>Paper Sizes</p> <ul style="list-style-type: none"> US Metric 	<p>Specify the unit of measurement for paper sizes.</p> <p>Notes:</p> <ul style="list-style-type: none"> • US is the factory default setting. • The initial setting is determined by your country or region selection in the initial setup wizard.
<p>Scan to PC Port Range [port range]</p>	<p>Specify a valid port range for printers behind a port blocking firewall.</p> <p>Note: 9751:12000 is the factory default setting.</p>

Use	To
<p>Displayed Information</p> <ul style="list-style-type: none"> Left side Right side Custom Text [x] 	<p>Specify what is displayed in the upper corners of the home screen.</p> <p>For the Left side and Right side menus, select from the following options:</p> <ul style="list-style-type: none"> None IP Address Hostname Contact Name Location Date/Time mDNS/DDNS Service Name Zero Configuration Name Custom Text [x] Model Name <p>Notes:</p> <ul style="list-style-type: none"> • IP Address is the factory default setting for Left side. • Date/Time is the factory default setting for Right side.
<p>Displayed Information (continued)</p> <ul style="list-style-type: none"> Black Toner 	<p>Customize the displayed information for supplies.</p> <p>Select from the following options:</p> <ul style="list-style-type: none"> When to display <ul style="list-style-type: none"> Do not display Display Message to display <ul style="list-style-type: none"> Default Alternate Default <ul style="list-style-type: none"> [text entry] Alternate <ul style="list-style-type: none"> [text entry] <p>Note: “Do not display” is the factory default setting for When to display.</p>
<p>Displayed Information (continued)</p> <ul style="list-style-type: none"> Paper Jam Load Paper Service Errors 	<p>Customize the displayed information for certain menus.</p> <p>Select from the following options:</p> <ul style="list-style-type: none"> Display <ul style="list-style-type: none"> Yes No Message to display <ul style="list-style-type: none"> Default Alternate Default <ul style="list-style-type: none"> [text entry] Alternate <ul style="list-style-type: none"> [text entry] <p>Note: No is the factory default setting for Display.</p>

Use	To
<p>Home screen customization</p> <ul style="list-style-type: none"> Change Language Copy Copy Shortcuts Fax Fax Shortcuts E-mail E-mail Shortcuts FTP FTP Shortcuts Search Held Jobs Held Jobs USB Drive Profiles and Apps Bookmarks Jobs by user Forms and Favorites Card Copy Scan to Network MyShortcut Multi Send 	<p>Change the icons that appear on the home screen.</p> <p>For each icon, select from the following options:</p> <ul style="list-style-type: none"> Display Do not display
<p>Date Format</p> <ul style="list-style-type: none"> MM-DD-YYYY DD-MM-YYYY YYYY-MM-DD 	<p>Format the date.</p> <p>Note: MM-DD-YYYY is the U.S. factory default setting. DD-MM-YYYY is the international factory default setting.</p>
<p>Time Format</p> <ul style="list-style-type: none"> 12 hour A.M./P.M. 24 hour clock 	<p>Format the time.</p> <p>Note: “12 hour A.M./P.M.” is the factory default setting.</p>
<p>Screen Brightness</p> <ul style="list-style-type: none"> 20–100 	<p>Specify the brightness of the display.</p> <p>Note: 100 is the factory default setting.</p>
<p>One Page Copy</p> <ul style="list-style-type: none"> Off On 	<p>Set copies from the scanner glass to only one page at a time.</p> <p>Note: Off is the factory default setting.</p>
<p>Output Lighting</p> <ul style="list-style-type: none"> Normal/Standby Mode Off Dim Bright 	<p>Set the amount of light from the standard bin.</p> <p>Notes:</p> <ul style="list-style-type: none"> • Dim is the factory default setting if Eco-Mode is set to Energy or Energy/Paper. • Bright is the factory default setting if Eco-Mode is Off or set to Paper.

Use	To
Audio Feedback Button Feedback On Off Volume 1–10	Set the audio volume for the buttons. Notes: <ul style="list-style-type: none"> • On is the factory default setting for Button Feedback. • 5 is the factory default setting for Volume.
Show Bookmarks Yes No	Specify whether bookmarks are displayed from the Held Jobs area. Note: Yes is the factory default setting.
Allow Background Removal On Off	Specify whether image background removal is allowed. Note: On is the factory default setting.
Allow Custom Job Scans On Off	Scan multiple jobs to one file. Note: On is the factory default setting. If On is selected, then the Allow Custom Job Scans setting can be enabled for specific jobs.
Scanner Jam Recovery Job level Page level	Specify how a scanned job should be reloaded if a paper jam occurs in the ADF. Notes: <ul style="list-style-type: none"> • Job level is the factory default setting. If Job level is selected, then rescan the entire job. • If Page level is selected, then rescan from the jammed page forward.
Web Page Refresh Rate 30–300	Specify the number of seconds between Embedded Web Server refreshes. Note: 120 is the factory default setting.
Contact Name	Specify a contact name for the printer. Note: The contact name is stored on the Embedded Web Server.
Location	Specify the location. Note: The location is stored on the Embedded Web Server.
Alarms Alarm Control Cartridge Alarm Staple Alarm	Set an alarm to sound when operator intervention is required. For each alarm type, select from the following options: Off Single Continuous Notes: <ul style="list-style-type: none"> • Single is the factory default setting for Alarm Control. This sounds several quick beeps. • Off is the factory default setting for Cartridge Alarm and Staple Alarm. • Continuous repeats several quick beeps in a regular interval.

Use	To
Timeouts Standby Mode Disabled 1–240	Set the amount of time before the printer enters a lower power state. Note: 15 minutes is the factory default setting.
Timeouts Sleep Mode Disabled 1–120	Set the amount of time the printer waits after a job is printed before it goes into a reduced power state. Notes: <ul style="list-style-type: none"> • 20 minutes is the factory default setting. • Lower settings conserve more energy, but may require longer warm-up times. • Select the lowest setting if the printer shares an electrical circuit with room lighting or you notice lights flickering in the room. • Select a high setting if the printer is in constant use. Under most circumstances, this keeps the printer ready to print with minimum warm-up time. • Disabled appears only if Energy Conserve is set to Off.
Timeouts Print with Display Off Allow printing with display off Display on when printing	Print a job while the display is off. Note: Display on when printing is the factory default setting.
Timeouts Hibernate Timeout Disabled 20 minutes 1–3 hours 6 hours 1–3 days 1–2 weeks 1 month	Set the amount of time before the printer enters Hibernate mode. Note: 3 days is the factory default setting.
Timeouts Hibernate Timeout on Connection Hibernate Do Not Hibernate	Set the printer to Hibernate mode even if there is an active Ethernet or phone connection. Note: Hibernate is the factory default setting.
Timeouts Screen Timeout 15–300	Set the amount of time the printer waits before returning the display to Ready state. Note: 30 is the factory default setting.
Timeouts Prolong Screen Timeout On Off	Continue a specified job without returning to the home screen when the screen timeout timer expires. Note: Off is the factory default setting.

Use	To
Timeouts Print Timeout Disabled 1–255	Set the amount of time the printer waits to receive an end-of-job message before canceling the rest of the print job. Notes: <ul style="list-style-type: none"> • 90 seconds is the factory default setting. • When the timer expires, any partially printed page still in the printer is printed. • Print Timeout is available only when using PCL emulation.
Timeouts Wait Timeout Disabled 15–65535	Set the amount of time the printer waits for additional data before canceling a print job. Notes: <ul style="list-style-type: none"> • 40 seconds is the factory default setting. • Wait Timeout is available only when the printer is using PostScript emulation.
Timeouts Job Hold Timeout 5–255	Set the amount of time the printer waits for user intervention before it holds jobs that require unavailable resources and continues to print other jobs in the print queue. Notes: <ul style="list-style-type: none"> • 30 is the factory default setting. • This menu item appears only when a hard disk is installed.
Error Recovery Auto Reboot Reboot when idle Reboot always Reboot never	Set the printer to restart when an error occurs. Note: Reboot always is the factory default setting.
Error Recovery Max Auto Reboots 1–20	Determine the number of automatic reboots the printer can perform. Notes: <ul style="list-style-type: none"> • 2 is the factory default setting. • When the number of reboots equals the specified value, then the error message appears.
Print Recovery Auto Continue Disabled 5–255	Let the printer automatically continue printing from certain offline situations when not resolved within the specified time period. Note: Disabled is the factory default setting.

Use	To
Print Recovery Jam Recovery On Off Auto	Specify whether the printer reprints jammed pages. Notes: <ul style="list-style-type: none"> • Auto is the factory default setting. The printer reprints jammed pages unless the memory required to hold the pages is needed for other printer tasks. • On sets the printer to always reprint jammed pages. • Off sets the printer to never reprint jammed pages.
Print Recovery Jam Assist On Off	Set the printer to automatically check for jammed paper. Note: On is the factory default setting.
Print Recovery Page Protect Off On	Successfully print a page that may not have printed otherwise. Notes: <ul style="list-style-type: none"> • Off is the factory default setting. This prints a partial page when there is not enough memory to print the whole page. • On sets the printer to print the entire page.
Press Sleep Button Do Nothing Sleep Hibernate	Determine how the printer, while in idle state, reacts to a short press of the Sleep button. Note: Sleep is the factory default setting.
Press and Hold Sleep Button Do Nothing Sleep Hibernate	Determine how the printer, while in idle state, reacts to a long press of the Sleep button. Note: Do Nothing is the factory default setting.
Factory Defaults Do Not Restore Restore Now	Use the printer factory default settings. Notes: <ul style="list-style-type: none"> • Do Not Restore is the factory default setting. • Restore Now returns all printer settings to the factory default settings except Network/Ports menu settings. All downloads stored in the RAM are deleted. Downloads stored in the flash memory or in a printer hard disk are not affected.
Export Configuration File Export	Export configuration files to a flash drive.

Copy Settings menu

Use	To
Content Type Text Graphics Text/Photo Photo	Specify the content of the original document. Note: Text/Photo is the factory default setting.
Content Source Black/White Laser Color Laser Inkjet Photo/Film Magazine Newspaper Press Other	Specify how the original document was produced. Note: Black/White Laser is the factory default setting.
Sides (Duplex) 1 sided to 1 sided 1 sided to 2 sided 2 sided to 1 sided 2 sided to 2 sided	Specify whether an original document is two-sided (duplex) or one-sided, and then specify whether the copy should be two-sided or one-sided. Notes: <ul style="list-style-type: none"> • 1 sided to 1 sided—The original document has print on one side and the copy will also have print on one side. • 1 sided to 2 sided—The original document has print on one side, while the copy will have print on both sides. • 2 sided to 1 sided—The original document has print on both sides, while the copy will have print on just one side. • 2 sided to 2 sided—The original document has print on both sides, and the copy will also have print on both sides.
Paper Saver Off 2-up Portrait 4-up Portrait 2-up Landscape 4-up Landscape	Copy two or four sheets of a document on one page. Note: Off is the factory default setting.
Print Page Borders On Off	Specify whether or not a border is printed. Note: Off is the factory default setting.
Collate (1,1,1) (2,2,2) (1,2,3) (1,2,3)	Keep the pages of a print job stacked in sequence when printing multiple copies. Note: “(1,2,3) (1,2,3)” is the factory default setting.
Staple Off On	Enable or disable the staple finisher. Notes: <ul style="list-style-type: none"> • Off is the factory default setting. • This menu item appears only when a staple finisher is installed.

Use	To
<p>Original Size</p> <ul style="list-style-type: none"> Letter Legal Executive Folio Statement Oficio (Mexico) Universal Auto Size Sense Mixed Sizes A4 A5 A6 JIS B5 Custom Scan Size [x] Book Original Business Card 3 x 5 in. 4 x 6 in. ID Card 	<p>Specify the paper size of the original document.</p> <p>Notes:</p> <ul style="list-style-type: none"> • Letter is the U.S. factory default setting. • A4 is the international factory default setting.
<p>Copy To Source</p> <ul style="list-style-type: none"> Tray [x] Auto Size Match Multipurpose Feeder 	<p>Specify the paper source for copy jobs.</p> <p>Note: Tray 1 is the factory default setting.</p>
<p>Transparency Separators</p> <ul style="list-style-type: none"> On Off 	<p>Place a sheet of paper between transparencies.</p> <p>Note: On is the factory default setting.</p>
<p>Separator Sheets</p> <ul style="list-style-type: none"> Off Between Copies Between Jobs Between Pages 	<p>Place a sheet of paper between pages, copies, or jobs.</p> <p>Note: Off is the factory default setting.</p>
<p>Separator Sheet Source</p> <ul style="list-style-type: none"> Tray [x] Multipurpose Feeder 	<p>Specify the paper source for separator sheet.</p> <p>Note: Tray 1 is the factory default setting.</p>
<p>Darkness</p> <ul style="list-style-type: none"> 1–9 	<p>Specify the level of darkness for the copy job.</p> <p>Note: 5 is the factory default setting.</p>
<p>Number of Copies</p> <ul style="list-style-type: none"> 1–999 	<p>Specify the number of copies for the copy job.</p> <p>Note: 1 is the factory default setting.</p>

Use	To
Header/Footer [Location] Off Date/Time Page number Custom text Print on All pages First page only All but first page Custom text	Specify the header or footer information and its location on the page. For the location, select from the following options: <ul style="list-style-type: none"> • Top left • Top middle • Top right • Bottom left • Bottom middle • Bottom right Notes: <ul style="list-style-type: none"> • Off is the factory default setting for the location. • “All pages” is the factory default setting for “Print on.”
Overlay Confidential Copy Draft Urgent Custom Off	Specify the overlay text printed on each page of the copy job. Note: Off is the factory default setting.
Custom Overlay	Specify the custom overlay text. Note: A maximum of 64 characters is allowed.
Allow priority copies On Off	Allow interruption of a print job to copy a page or document. Note: On is the factory default setting.
Custom Job scanning On Off	Scan a document that contains mixed paper sizes into a single copy job. Notes: <ul style="list-style-type: none"> • Off is the factory default setting. • This menu item appears only when a formatted, working printer hard disk is installed.
Allow Save as Shortcut On Off	Save custom copy settings as shortcuts. Note: On is the factory default setting.
Background Removal -4 to 4	Adjust the amount of background visible on a copy. Note: 0 is the factory default setting.
Auto Center Off On	Automatically align the content at the center of the page. Note: Off is the factory default setting.

Use	To
Color Dropout Color Dropout None Red Green Blue Default Red Threshold 0–255 Default Green Threshold 0–255 Default Blue Threshold 0–255	Specify which color to drop during scanning and to adjust the dropout setting for each color threshold. Notes: <ul style="list-style-type: none"> • None is the factory default setting for Color Dropout. • 128 is the factory default setting for each color threshold.
Contrast 0–5 Best for content	Specify the contrast used for the copy job. Note: “Best for content” is the factory default setting.
Mirror Image Off On	Create a mirror image of the original document. Note: Off is the factory default setting.
Negative Image Off On	Create a negative image of the original document. Note: Off is the factory default setting.
Shadow Detail -4 to 4	Adjust the amount of shadow detail visible on a copy. Note: 0 is the factory default setting.
Adjust ADF Skew Auto Off On	Correct slight skew in the scanned image. Note: Off is the factory default setting.
Scan edge to edge Off On	Specify if the original document is scanned edge-to-edge prior to faxing. Note: Off is the factory default setting.
Sharpness 1–5	Adjust the amount of sharpness of a copy. Note: 3 is the factory default setting.
Sample Copy Off On	Create a sample copy of the original document. Note: Off is the factory default setting.

Fax Settings menu

Fax Mode (Analog Fax Setup) menu

Analog Fax Setup mode sends the fax job through a telephone line.

Note: The fax function is available only in select printer models.

Use	To
Fax Name	Specify the name of the fax in the printer.
Fax Number	Specify the number assigned to the fax.
Fax ID Fax Name Fax Number	Specify how the fax is identified.
Enable Manual Fax On Off	Set the printer to fax manually, which requires a line splitter and a telephone handset. Notes: <ul style="list-style-type: none"> • Off is the factory default setting. • Use a regular telephone to answer an incoming fax job and to dial a fax number. • Press # 0 on the numeric keypad to go directly to the Manual Fax function.
Memory Use All receive Mostly receive Equal Mostly send All send	Define the allocation of non-volatile memory between sending and receiving fax jobs. Notes: <ul style="list-style-type: none"> • Equal is the factory default setting. This splits the memory for sending and receiving fax jobs into equal amounts. • “Mostly send” specifies that most of the memory is set to send fax jobs. • “All send” specifies that all the memory is set to send fax jobs. • “All receive” specifies that all the memory is set to receive fax jobs. • “Mostly receive” specifies that most of the memory is set to receive fax jobs.
Cancel Faxes Allow Don't Allow	Specify whether or not the printer cancels fax jobs. Note: Allow is the factory default setting.
Caller ID Off Primary Alternate	Specify the type of caller ID being used.
Fax number masking Off From left From right	Specify the direction from where digits are masked in an outgoing fax number. Notes: <ul style="list-style-type: none"> • Off is the factory default setting. • The number of characters masked is determined by the “Digits to mask” setting.
Digits to Mask 0–58	Specify the number of digits to mask in an outgoing fax number. Note: 0 is the factory default setting.

Use	To
<p>Fax Cover Page</p> <ul style="list-style-type: none"> Fax Cover Page <ul style="list-style-type: none"> Off by default On by default Never use Always use Include to Field <ul style="list-style-type: none"> On Off Include from Field <ul style="list-style-type: none"> On Off From <ul style="list-style-type: none"> Include Message Field <ul style="list-style-type: none"> On Off Message <ul style="list-style-type: none"> Include Logo <ul style="list-style-type: none"> On Off Include Footer [x] <ul style="list-style-type: none"> On Off Footer [x] 	<p>Configure the fax cover page.</p> <p>Notes:</p> <ul style="list-style-type: none"> • “Off by default” is the factory default setting for Fax Cover Page. • Off is the factory default setting for all other menu items.
<p>Resolution</p> <ul style="list-style-type: none"> Standard Fine 200 dpi Super Fine 300 dpi Ultra Fine 600 dpi 	<p>Specify quality in dots per inch (dpi). A higher resolution gives better print quality, but increases the fax transmission time for outgoing faxes.</p> <p>Note: Standard is the factory default setting.</p>

Use	To
<p>Original Size</p> <ul style="list-style-type: none"> Letter Legal Executive Folio Statement Oficio (Mexico) Universal Auto Size Sense Mixed Sizes A4 A5 A6 JIS B5 Custom Scan Size [x] Book Original Business Card 3 x 5 in. 4 x 6 in. 	<p>Specify the paper size of the original document.</p> <p>Note: Mixed Sizes is the U.S. factory default setting. A4 is the international factory default setting.</p>
<p>Sides (Duplex)</p> <ul style="list-style-type: none"> Off Long edge Short edge 	<p>Specify the page orientation of text and graphics.</p> <p>Notes:</p> <ul style="list-style-type: none"> • Off is the factory default setting. • Long edge assumes binding along the long edge of the page (left edge for portrait and top edge for landscape). • Short edge assumes binding along the short edge of the page (top edge for portrait and left edge for landscape).
<p>Content Type</p> <ul style="list-style-type: none"> Text Graphics Text/Photo Photo 	<p>Specify the content of the original document.</p> <p>Note: Text is the factory default setting.</p>
<p>Content Source</p> <ul style="list-style-type: none"> Black/White Laser Color Laser Inkjet Photo/Film Magazine Newspaper Press Other 	<p>Specify how the original document was produced.</p> <p>Note: Black/White Laser is the factory default setting.</p>
<p>Darkness</p> <ul style="list-style-type: none"> 1–9 	<p>Lighten or darken the output.</p> <p>Note: 5 is the factory default setting.</p>
<p>Dial Prefix</p>	<p>Enter a dialing prefix, such as 99. A numeric entry field is provided.</p>

Use	To
Dialing Prefix Rules Prefix Rule [x]	Establish a dialing prefix rule.
Automatic Redial 0–9	Specify the number of times the printer tries to send the fax to a specified number. Note: 5 is the factory default setting.
Redial frequency 1–200	Specify the number of minutes between redials. Note: 3 is the factory default setting.
Behind a PABX Yes No	Enable or disable switchboard blind dialing without a dial tone. Note: No is the factory default setting.
Enable ECM Yes No	Enable or disable Error Correction Mode for fax jobs. Note: Yes is the factory default setting.
Enable Fax Scans On Off	Fax files that are scanned at the printer. Note: On is the factory default setting.
Driver to fax Yes No	Allow the printer driver to send fax jobs. Note: Yes is the factory default setting.
Allow Save as Shortcut On Off	Save fax numbers as shortcuts in the printer. Note: On is the factory default setting.
Dial Mode Tone Pulse	Specify the dialing sound, either as a tone or as a pulse. Note: Tone is the factory default setting.
Max Speed 2400 4800 9600 14400 33600	Specify the maximum speed in baud at which faxes are sent. Note: 33600 is the factory default setting.
Custom Job scanning On Off	Scan a document that contains mixed paper sizes into a single file. Notes: <ul style="list-style-type: none"> • Off is the factory default setting. • This menu item appears only when a formatted, working printer hard disk is installed.
Scan Preview On Off	Specify whether a preview will appear on the display for scan jobs. Notes: <ul style="list-style-type: none"> • Off is the factory default setting. • This menu item appears only when a formatted, working printer hard disk is installed.

Use	To
Background Removal -4 to 4	Adjust the amount of background visible on a scanned image. Note: 0 is the factory default setting.
Contrast 0–5 Best for content	Specify the contrast in the scanned image. Note: “Best for content” is the factory default setting.
Mirror Image Off On	Create a mirror image of the original document. Note: Off is the factory default setting.
Negative Image Off On	Create a negative image of the original document. Note: Off is the factory default setting.
Shadow Detail -4 to 4	Adjust the amount of shadow detail visible. Note: 0 is the factory default setting.
Adjust ADF Skew Auto Off On	Correct the slight skew in the scanned image. Notes: <ul style="list-style-type: none"> • Off is the factory default setting. • This menu item is supported only in select printer models.
Scan edge to edge Off On	Specify if the original document is scanned edge-to-edge prior to faxing. Note: Off is the factory default setting.
Sharpness 1–5	Adjust the sharpness of a fax. Note: 3 is the factory default setting.
Temperature -4 to 4	Specify “warm” or “cool” outputs. “Cool” values generate a bluer output than the default while “warm” values generate a redder output than the default. Note: 0 is the factory default setting.
Auto Convert Color Faxes to Mono Faxes On Off	Convert all outgoing faxes to black and white. Note: On is the factory default setting.
Use	To
Enable Fax Receive On Off	Allow the printer to receive fax jobs. Note: On is the factory default setting.
Fax Job Waiting None Toner Toner and Supplies	Remove fax jobs from the print queue when the job requires specific unavailable resources. Note: None is the factory default setting.
Rings to Answer 1–25	Specify the number of rings before answering an incoming fax job. Note: 3 is the factory default setting.

Use	To
Auto Reduction On Off	Scale an incoming fax job so that it fits the size of the paper loaded in the designated fax source. Note: On is the factory default setting.
Paper Source Auto Tray [x] Multipurpose Feeder	Specify the paper source for printing incoming fax jobs. Note: Auto is the factory default setting.
Sides (Duplex) Off On	Enable two-sided (duplex) printing for incoming fax jobs. Notes: <ul style="list-style-type: none"> • Off is the factory default setting. • This menu item appears only when a print duplexer is installed.
Separator Sheets Off Before Job After Job	Enable the printer to include separator sheets for incoming fax jobs. Note: Off is the factory default setting.
Separator Sheet Source Tray [x] Multipurpose Feeder	Specify where the printer will pick the separator sheet. Note: Tray 1 is the factory default setting.
Fax Footer On Off	Print the transmission information at the bottom of each page from a received fax. Note: Off is the factory default setting.
Max Speed 2400 4800 9600 14400 33600	Specify the maximum speed in baud at which faxes are received. Note: 33600 is the factory default setting.
Fax Forwarding Print Print and Forward Forward	Enable forwarding of received faxes to another recipient. Note: Print is the factory default setting.
Forward to Fax E-mail FTP LDSS eSF	Specify the type of recipient to which faxes will be forwarded. Notes: <ul style="list-style-type: none"> • Fax is the factory default setting. • This menu item is available only from the Embedded Web Server.
Forward to Shortcut	Enter the shortcut number which matches the recipient type (Fax, E-mail, FTP, LDSS, or eSF). Note: You can enter up to 16 characters.

Use	To
Block No Name Fax Off On	Enable blocking of incoming faxes sent from devices with no station ID or fax ID specified. Note: Off is the factory default setting.
Banned Fax List	Enable the list of blocked fax numbers stored in the printer. Note: You can enter up to 512 characters.
Use	To
Transmission Log Print log Do not print log Print only for error	Enable printing of a transmission log after each fax job. Note: "Print log" is the factory default setting.
Receive Error Log Print Never Print on Error	Enable printing of a receive error log following a receive error. Note: Print Never is the factory default setting.
Auto Print Logs On Off	Enable automatic printing of fax logs. Notes: <ul style="list-style-type: none"> • On is the factory default setting. • Logs print after every 200 fax jobs.
Log Paper Source Tray [x] Multipurpose Feeder	Specify the source of the paper used for printing logs. Note: Tray 1 is the factory default setting.
Logs Display Remote Station Name Dialed Number	Specify whether printed logs display the dialed number or the station name or fax name returned. Note: Remote Station Name is the factory default setting.
Enable Job Log On Off	Enable access to the Fax Job log. Note: On is the factory default setting.
Enable Call Log On Off	Enable access to the Fax Call log. Note: On is the factory default setting.
Use	To
Speaker Mode Always Off On until Connected Always On	Specify the mode of the speaker. Notes: <ul style="list-style-type: none"> • On until Connected is the factory default setting. A sound is issued until the fax connection is made. • Always On turns the speaker on. • Always Off turns the speaker off.
Speaker Volume High Low	Control the volume setting. Note: High is the factory default setting.

Use	To
Ringer Volume Off On	Control the fax speaker ringer volume. Note: On is the factory default setting.
Use All Rings Single Ring Only Double Ring Only Triple Ring Only Single or Double Rings Only Single or Triple Rings Only Double or Triple Rings Only	Specify ring patterns when the printer is answering calls. Note: All Rings is the factory default setting.

E-mail Settings menu

Use	To
E-mail Server Setup Subject Message File Name	Specify e-mail server information. Notes: <ul style="list-style-type: none"> You can enter up to 255 characters in the Subject field. You can enter up to 512 characters in the Message field. You can enter up to 53 characters in the File Name field.
E-mail Server Setup Send me a copy Never appears On by default Off by default Always On	Send a copy of the e-mail to the sender. Note: "Never appears" is the factory default setting.
E-mail Server Setup Max E-mail size 0–65535 KB	Specify the maximum e-mail size in kilobytes. Note: E-mails above the specified size are not sent.
E-mail Server Setup Size Error Message	Send a message when an e-mail is greater than the configured size limit. Note: You can enter up to 1024 characters.
E-mail Server Setup Limit destinations	Specify a domain name, such as a company domain name, and then limit e-mail destinations only to that domain name. Note: You can specify only one domain.

Use	To
E-mail Server Setup Web Link Setup Server Login Password Path File Name Web Link	Define the e-mail server path name, for example: <code>/directory/path</code> . Notes: <ul style="list-style-type: none"> • The characters * : ? < > are invalid entries for a path name. • You can enter up to 128 characters for Server, Login, Password, Path, and Web Link. • You can enter up to 53 characters for File Name.
Format PDF (.pdf) Secure PDF TIFF (.tif) JPEG (.jpg) XPS (.xps)	Specify the format of the scanned file. Note: "PDF (.pdf)" is the factory default setting.
PDF Version 1.2–1.7 A–1a	Set the version of the PDF file that will be scanned for e-mailing. Note: 1.5 is the factory default setting.
Content Type Text Graphics Text/Photo Photo	Specify the content of the original document. Note: Text/Photo is the factory default setting.
Content Source Black/White Laser Color Laser Inkjet Photo/Film Magazine Newspaper Press Other	Specify how the original document was produced. Note: Black/White Laser is the factory default setting.
Color Off On	Specify whether copies are printed in color.
Resolution 75 dpi 150 dpi 200 dpi 300 dpi 400 dpi 600 dpi	Specify the resolution of the scan in dots per inch. Note: "150 dpi" is the factory default setting.
Darkness 1–9	Lighten or darken the output. Note: 5 is the factory default setting.

Use	To
Orientation Portrait Landscape	Specify the page orientation of the scanned image. Note: Portrait is the factory default setting.
Original Size Letter Legal Executive Folio Statement Oficio (Mexico) Universal Auto Size Sense Mixed Sizes A4 A5 A6 JIS B5 Custom Scan Size [x] Book Original Business Card 3 x 5 in. 4 x 6 in.	Specify the paper size of the document being scanned. Notes: <ul style="list-style-type: none"> • Letter is the U.S. factory default setting. • A4 is the international factory default setting.
Sides (Duplex) Off Long edge Short edge	Specify the page orientation of text and graphics. Notes: <ul style="list-style-type: none"> • Off is the factory default setting. • “Long edge” assumes binding along the long edge of the page (left edge for portrait and top edge for landscape). • “Short edge” assumes binding along the short edge of the page (top edge for portrait and left edge for landscape).
JPEG Quality Best for content 5–90	Set the quality of a JPEG photo image in relation to file size and quality of the image. Notes: <ul style="list-style-type: none"> • “Best for content” is the factory default setting. • 5 reduces the file size and quality of the image. • 90 provides the best image quality, but the file size is very large. • This menu item applies to all scan functions.
Text Default 5–90	Set the quality of a text image in relation to file size and quality of the image. Note: 75 is the factory default setting.
Text/Photo Default 5–90	Set the quality of a text or photo image in relation to file size and the quality of the image. Note: 75 is the factory default setting.

Use	To
Photo Default 5–90	Set the quality of a photo image in relation to file size and the quality of the image. Note: 50 is the factory default setting.
E-mail images sent as Attachment Web Link	Specify how the images are sent. Note: Attachment is the factory default setting.
Use Multi-Page Tiff On Off	Provide a choice between single-page TIFF files and multiple-page TIFF files. For a multiple-page scan-to-e-mail job, either one TIFF file is created containing all the pages, or multiple TIFF files are created with one file for each page of the job. Notes: <ul style="list-style-type: none"> • On is the factory default setting. • This menu item applies to all scan functions.
Transmission Log Print log Do not print log Print only for error	Specify whether or not the transmission log prints. Note: “Print log” is the factory default setting.
Log Paper Source Tray [x] Multipurpose Feeder	Specify the paper source for printing e-mail logs. Note: Tray 1 is the factory default setting.
E-mail Bit Depth 1 bit 8 bit	Enable the Text/Photo mode to produce smaller file sizes by using 1-bit images. Note: “8 bit” is the factory default setting.
Custom Job scanning On Off	Copy a document that contains mixed paper sizes. Notes: <ul style="list-style-type: none"> • Off is the factory default setting. • This menu item appears only when a formatted, working printer hard disk is installed.
Scan Preview On Off	Specify whether or not a preview will appear on the display for scan jobs. Notes: <ul style="list-style-type: none"> • Off is the factory default setting. • This menu item appears only when a formatted, working printer hard disk is installed.
Allow Save as Shortcut On Off	Save e-mail addresses as shortcuts. Notes: <ul style="list-style-type: none"> • On is the factory default setting. • When set to Off, the Save as Shortcut button does not appear on the e-mail Destination screen.
Background Removal -4 to 4	Adjust the amount of background visible on a scanned image. Note: 0 is the factory default setting.

Use	To
Color Balance Cyan-Red Magenta-Green Yellow-Blue	Enable an equal balance of colors in the output.
Color Dropout Color Dropout None Red Green Blue Default Red Threshold 0–255 Default Green Threshold 0–255 Default Blue Threshold 0–255	Specify which color to drop during scanning and to adjust the dropout setting for each color threshold. Notes: <ul style="list-style-type: none"> • None is the factory default setting for Color Dropout. • 128 is the factory default setting for each color threshold.
Contrast 0–5 Best for content	Specify the contrast of the output. Note: “Best for content” is the factory default setting.
Mirror Image Off On	Create a mirror image of the original document. Note: Off is the factory default setting.
Negative Image Off On	Create a negative image of the original document. Note: Off is the factory default setting.
Shadow Detail -4 to 4	Adjust the amount of shadow detail visible on a scanned image. Note: 0 is the factory default setting.
Adjust ADF Skew Auto Off On	Correct slight skew in the scanned image. Notes: <ul style="list-style-type: none"> • Auto is the factory default setting. • This menu item appears only in select printer models.
Scan edge to edge Off On	Specify whether the original document is scanned edge-to-edge. Note: Off is the factory default setting.
Sharpness 1–5	Adjust the amount of sharpness on a scanned image. Note: 3 is the factory default setting.
Temperature -4 to 4	Enable the user to specify “warm” or “cool” outputs. “Cool” values generate a bluer output than the default, while “warm” values generate a redder output than the default. Note: 0 is the factory default setting.

Use	To
Use cc:/bcc: Off On	Enable the use of the cc and bcc fields. Note: Off is the factory default setting.

FTP Settings menu

Use	To
Format PDF (.pdf) Secure PDF (.pdf) TIFF (.tif) JPEG (.jpg) XPS (.xps)	Specify the format of the file for FTP sending. Note: PDF (.pdf) is the factory default setting.
PDF Version 1.2–1.7 A–1a	Set the version level of the PDF file for FTP sending. Note: 1.5 is the factory default setting.
Content Type Text Graphics Text/Photo Photo	Specify the content of the original document. Note: Text/Photo is the factory default setting.
Content Source Black/White Laser Color Laser Inkjet Photo/Film Magazine Newspaper Press Other	Specify how the original document was produced. Note: Black/White Laser is the factory default setting.
Color Off On	Specify whether or not copies are printed in color. Note: On is the factory default setting.
Resolution 75 dpi 150 dpi 200 dpi 300 dpi 400 dpi 600 dpi	Specify the quality of the scan in dots per inch (dpi). Note: “150 dpi” is the factory default setting.
Darkness 1–9	Lighten or darken the output. Note: 5 is the factory default setting.

Use	To
Orientation Portrait Landscape	Specify the page orientation of the scanned image. Note: Portrait is the factory default setting.
Original Size Letter Legal Executive Folio Statement Oficio (Mexico) Universal Auto Size Sense Mixed Sizes A4 A5 A6 JIS B5 Custom Scan Size [x] Book Original Business Card 3 x 5 in. 4 x 6 in.	Specify the paper size of the original document. Notes: <ul style="list-style-type: none"> • Letter is the U.S. factory default setting. • A4 is the international factory default setting.
Sides (Duplex) Off Long edge Short edge	Specify the page orientation of text and graphics. Notes: <ul style="list-style-type: none"> • Off is the factory default setting. • “Long edge” assumes binding along the long edge of the page (left edge for portrait and top edge for landscape). • “Short edge” assumes binding along the short edge of the page (top edge for portrait and left edge for landscape).
JPEG Quality Best for content 5–90	Set the quality of a JPEG photo image in relation to the file size and quality of the image. Notes: <ul style="list-style-type: none"> • “Best for content” is the factory default setting. • 5 reduces the file size, but the quality of the image is lessened. • 90 provides the best image quality, but the file size is very large. • This menu item applies to all scan functions.
Text Default 5–90	Set the quality of the text in relation to the file size and quality of the image. Note: 75 is the factory default setting.
Text/Photo Default 5–90	Set the quality of a text/photo image in relation to the file size and quality of the image. Note: 75 is the factory default setting.

Use	To
Photo Default 5–90	Set the quality of a photo image in relation to the file size and quality of the image. Note: 50 is the factory default setting.
Use Multi-Page TIFF On Off	Provide a choice between single-page TIFF files and multiple-page TIFF files. For a multiple-page scan-to-FTP job, either one TIFF file is created containing all the pages, or multiple TIFF files are created with one file for each page of the job. Notes: <ul style="list-style-type: none"> • On is the factory default setting. • This menu item applies to all scan functions.
Transmission Log Print log Do not print log Print only for error	Specify whether the transmission log prints. Note: “Print log” is the factory default setting.
Log Paper Source Tray [x] Multipurpose Feeder	Specify a paper source when printing FTP logs. Note: Tray 1 is the factory default setting.
FTP bit Depth 1 bit 8 bit	Enable the Text/Photo mode to have smaller file sizes by using 1-bit images. Note: 8 bit is the factory default setting.
File Name	Type a base file name. Note: You can enter up to 53 characters.
Custom Job Scanning On Off	Copy a document that contains mixed paper sizes into a single scan job. Note: Off is the factory default setting.
Scan Preview On Off	Specify whether a preview will appear on the display for scan jobs. Notes: <ul style="list-style-type: none"> • Off is the factory default setting. • This menu item appears only when a formatted, working printer hard disk is installed.
Allow Save as Shortcut On Off	Enable shortcut creation for FTP addresses. Note: On is the factory default setting.
Background Removal -4 to 4	Adjust the amount of background visible on a copy. Note: 0 is the factory default setting.
Color Balance Cyan-Red Magenta-Green Yellow-Blue	Enable an equal balance of colors in the output.

Use	To
<p>Color Dropout</p> <p>Color Dropout</p> <ul style="list-style-type: none"> None Red Green Blue <p>Default Red Threshold</p> <p>0–255</p> <p>Default Green Threshold</p> <p>0–255</p> <p>Default Blue Threshold</p> <p>0–255</p>	<p>Specify which color to drop during scanning, and how much the dropout is increased or decreased.</p> <p>Notes:</p> <ul style="list-style-type: none"> • None is the factory default setting for Color Dropout. • 128 is the factory default setting for each color threshold.
<p>Contrast</p> <p>0–5</p> <p>Best for content</p>	<p>Specify the contrast of the output.</p> <p>Note: “Best for content” is the factory default setting.</p>
<p>Mirror Image</p> <p>Off</p> <p>On</p>	<p>Create a mirror image of the original document.</p> <p>Note: Off is the factory default setting.</p>
<p>Negative Image</p> <p>Off</p> <p>On</p>	<p>Create a negative image of the original document.</p> <p>Note: Off is the factory default setting.</p>
<p>Shadow Detail</p> <p>-4 to 4</p>	<p>Adjust the amount of shadow detail visible on a scanned image.</p> <p>Note: 0 is the factory default setting.</p>
<p>Adjust ADF Skew</p> <p>Auto</p> <p>Off</p> <p>On</p>	<p>Correct slight skew in the scanned image.</p> <p>Notes:</p> <ul style="list-style-type: none"> • Auto is the factory default setting. • This menu item is supported only in select printer models.
<p>Scan edge to edge</p> <p>Off</p> <p>On</p>	<p>Specify whether the original document is scanned edge-to-edge.</p> <p>Note: Off is the factory default setting.</p>
<p>Sharpness</p> <p>1–5</p>	<p>Adjust the amount of sharpness of a scanned image.</p> <p>Note: 3 is the factory default setting.</p>
<p>Temperature</p> <p>-4 to 4</p>	<p>Enable the user to specify “warm” or “cool” outputs. “Cool” values generate a bluer output than the default while “warm” values generate a redder output than the default.</p> <p>Note: 0 is the factory default setting.</p>

Flash Drive menu

Scan Settings

Use	To
Format PDF (.pdf) Secure PDF TIFF (.tif) JPEG (.jpg) XPS (.xps)	Specify the format of the file to be sent through FTP. Note: "PDF (.pdf)" is the factory default setting.
PDF Version 1.2–1.7 A-1a	Set the version of the PDF file to be sent through FTP. Note: 1.5 is the factory default setting.
Content Type Text Graphics Text/Photo Photo	Specify the content of the original document. Note: Text/Photo is the factory default setting.
Content Source Black and White Laser Color Laser Inkjet Photo/Film Magazine Newspaper Press Other	Specify how the original document was produced. Note: "Black and White Laser" is the factory default setting.
Resolution 75 dpi 150 dpi 200 dpi 300 dpi 400 dpi 600 dpi	Specify the resolution of the scan in dots per inch (dpi). Note: "150 dpi" is the factory default setting.
Darkness 1–9	Lighten or darken the output. Note: 5 is the factory default setting.
Orientation Portrait Landscape	Specify the orientation of the scanned image. Note: Portrait is the factory default setting.

Use	To
<p>Original Size</p> <ul style="list-style-type: none"> Letter Legal Executive Folio Statement Oficio (Mexico) Auto Size Sense Mixed Sizes A4 A5 A6 JIS B5 Difficult Media Letter Difficult Media A5 Difficult Media Legal Difficult Media A4 Custom Scan Size [x] Book Original Business Card 3 x 5 in. 4 x 6 in. 	<p>Specify the paper size of the original document.</p> <p>Note: Letter is the U.S. factory default setting. A4 is the international factory default setting.</p>
<p>Sides (Duplex)</p> <ul style="list-style-type: none"> Off Long Edge Short Edge 	<p>Specify the page orientation of text and graphics.</p> <p>Notes:</p> <ul style="list-style-type: none"> • Off is the factory default setting. • Long Edge assumes binding along the long edge of the page (left edge for portrait and top edge for landscape). • Short Edge assumes binding along the short edge of the page (top edge for portrait and left edge for landscape).
<p>JPEG Quality</p> <ul style="list-style-type: none"> Best for content 5–90 	<p>Set the quality of a JPEG photo image in relation to file size and quality.</p> <p>Notes:</p> <ul style="list-style-type: none"> • “Best for content” is the factory default setting. • 5 reduces the file size, but the quality of the image is lessened. • 90 provides the best image quality, but the file size is very large. • This menu item applies to all scan functions.
<p>Text Default</p> <ul style="list-style-type: none"> 5–90 	<p>Set the quality of the text in relation to file size and the quality of the image.</p> <p>Note: 75 is the factory default setting.</p>
<p>Text/Photo Default</p> <ul style="list-style-type: none"> 5–90 	<p>Set the quality of a text/photo image in relation to file size and quality.</p> <p>Note: 75 is the factory default setting.</p>
<p>Photo Default</p> <ul style="list-style-type: none"> 5–90 	<p>Set the quality of a photo image in relation to file size and quality.</p> <p>Note: 50 is the factory default setting.</p>

Use	To
Use Multi-Page TIFF On Off	Provide a choice between single-page TIFF files and multiple-page TIFF files. For a multiple-page scan to FTP job, either one TIFF file is created containing all the pages, or multiple TIFF files are created with one file for each page. Notes: <ul style="list-style-type: none"> • On is the factory default setting. • This menu item applies to all scan functions.
File Name	Type a base file name. Note: A maximum of 53 characters is allowed.
Custom Job Scanning On Off	Copy a document containing mixed paper sizes in a single copy job. Note: Off is the factory default setting.
Scan Preview On Off	Specify whether a preview appears on the display for scan jobs. Note: Off is the factory default setting.
Background Removal -4 to 4	Adjust the amount of background visible on a copy. Note: 0 is the factory default setting.
Contrast 0–5 Best for content	Specify the contrast of the scanned image. Note: “Best for content” is the factory default setting.
Mirror Image Off On	Create a mirror image of the original document. Note: Off is the factory default setting.
Negative Image Off On	Create a negative image of the original document. Note: Off is the factory default setting.
Shadow Detail -4 to 4	Adjust the amount of shadow detail visible on a scanned image. Note: 0 is the factory default setting.
Scan edge to edge Off On	Specify whether the original document is scanned edge-to-edge. Note: Off is the factory default setting.
Sharpness 1–5	Adjust the amount of sharpness on a scanned image. Note: 3 is the factory default setting.
Temperature -4 to 4	Enable the user to specify “warm” or “cool” outputs. “Cool” values generate a bluer output than the default while “warm” values generate a redder output than the default.

Print Settings

Copies 1–999	Specify a default number of copies for each print job. Note: 1 is the factory default setting.
Paper Source Tray [x] Multipurpose Feeder Manual Paper Manual Envelope	Set a default paper source for all print jobs. Note: Tray 1 is the factory default setting.
Collate (1,1,1) (2,2,2) (1,2,3) (1,2,3)	Stack the pages of a print job in sequence when printing multiple copies. Note: “(1,2,3) (1,2,3)” is the factory default setting.
Sides (Duplex) 1 sided 2 sided	Specify whether prints are on one side or on both sides of the page. Note: “1 sided” is the factory default setting.
Staple Off On	Specify whether prints are stapled. Notes: <ul style="list-style-type: none"> • Off is the factory default setting. • This menu appears only when a staple finisher is installed.
Duplex Binding Long Edge Short Edge	Define binding for duplexed pages in relation to page orientation. Notes: <ul style="list-style-type: none"> • Long Edge assumes binding along the long edge of the page (left edge for portrait and top edge for landscape). • Short Edge assumes binding along the short edge of the page (top edge for portrait and left edge for landscape).
Paper Saver Off 2-Up 3-Up 4-Up 6-Up 9-Up 12-Up 16-Up	Specify that multiple-page images be printed on one side of a paper. Notes: <ul style="list-style-type: none"> • Off is the factory default setting. • The number selected is the number of page images that will print per side.
Paper Saver Ordering Horizontal Reverse Horizontal Reverse Vertical Vertical	Specify the positioning of multiple-page images. Notes: <ul style="list-style-type: none"> • Horizontal is the factory default setting. • Positioning depends on the number of page images and whether they are in portrait or landscape orientation.

Paper Saver Orientation Auto Landscape Portrait	Specify the orientation of a multiple-page document. Note: Auto is the factory default setting. The printer chooses between portrait and landscape.
Paper Saver Border None Solid	Print a border on each page image. Note: None is the factory default setting.
Separator Sheets Off Between Copies Between Jobs Between Pages	Specify whether blank separator sheets are inserted. Notes: <ul style="list-style-type: none"> • Off is the factory default setting. • Between Copies inserts a blank sheet between each copy of a print job if Collate is set to "(1,2,3) (1,2,3)." If Collate is set to "(1,1,1) (2,2,2)," then a blank page is inserted between each set of printed pages, such as after all page 1's and after all page 2's. • Between Jobs inserts a blank sheet between print jobs. • Between Pages inserts a blank sheet between each page of the print job. This setting is useful when printing transparencies or when inserting blank pages in a document .
Separator Sheet Source Tray [x] Multipurpose Feeder	Specify the paper source for separator sheets. Note: Tray 1 is the factory default setting.
Blank Pages Do Not Print Print	Specify whether blank pages are inserted in a print job. Note: Do Not Print is the factory default setting.

Print Settings

Setup menu

Use	To
Printer Language PCL Emulation PS Emulation	Set the printer language. Notes: <ul style="list-style-type: none"> • PCL Emulation is the factory default setting. • Setting a printer language as the default does not prevent a software program from sending print jobs that use another printer language.

Use	To
Job Waiting On Off	<p>Specify that print jobs be removed from the print queue if they require unavailable printer options or custom settings.</p> <p>Print jobs removed from the print queue are stored in a separate print queue, so other jobs print normally. When the missing information or options are obtained, the stored jobs print.</p> <p>Notes:</p> <ul style="list-style-type: none"> • Off is the factory default setting. • This menu setting appears only when a formatted, working printer hard disk is installed. This requirement ensures that stored jobs are not deleted if the printer loses power.
Print Area Normal Whole Page	<p>Set the logical and physical printable area.</p> <p>Notes:</p> <ul style="list-style-type: none"> • Normal is the factory default setting. When attempting to print data in the non-printable area defined by the Normal setting, the printer clips the image at the boundary. • Whole Page allows the image to be moved into the non-printable area defined by the Normal setting, but the printer will clip the image at the Normal setting boundary. This affects only pages printed using a PCL 5e interpreter. This has no effect on pages printed using the PCL XL or PostScript interpreter.
Download Target RAM Flash Disk	<p>Set the storage location for downloads.</p> <p>Notes:</p> <ul style="list-style-type: none"> • RAM is the factory default setting. Storing downloads in the RAM is temporary. • Storing downloads in flash memory or on a printer hard disk places them in permanent storage. Downloads remain in flash memory or on the printer hard disk even when the printer is turned off. • This menu setting appears only when a formatted, working flash drive or printer hard disk is installed.
Resource Save On Off	<p>Specify how the printer handles temporary downloads, such as fonts and macros stored in the RAM, when the printer receives a job that requires more memory than is available.</p> <p>Notes:</p> <ul style="list-style-type: none"> • Off is the factory default setting. This sets the printer to retain the downloads only until memory is needed. Downloads are deleted in order to process print jobs. • On retains the downloads during language changes and printer resets. If the printer runs out of memory, then Memory Full [38] appears, and downloads are not deleted.

Use	To
Print All Order Alphabetical Oldest First Newest First	Specify the order in which held and confidential jobs are printed when Print All is selected. Note: Alphabetical is the factory default setting. Print jobs always appear in alphabetical order on the printer control panel.

Finishing menu

Use	To
Sides (Duplex) 1 sided 2 sided	Specify whether two-sided (duplex) printing is set as the default for all print jobs. Notes: <ul style="list-style-type: none"> • “1 sided” is the factory default setting. • You can set two-sided printing from the printer software. For Windows users: Click File > Print, and then click Properties, Preferences, Options, or Setup. For Macintosh users: Choose File > Print, and then adjust the settings from the Print dialog and pop-up menus.
Duplex Binding Long Edge Short Edge	Define the way duplexed pages are bound and printed in relation to page orientation. Notes: <ul style="list-style-type: none"> • Long Edge is the factory default setting. This assumes binding along the long edge of the page (left edge for portrait and top edge for landscape). • Short Edge assumes binding along the short edge of the page (top edge for portrait and left edge for landscape).
Copies 1–999	Specify the default number of copies for each print job. Note: 1 is the factory default setting.
Blank Pages Do Not Print Print	Specify whether blank pages are inserted in a print job. Note: Do Not Print is the factory default setting.
Collate (1,1,1) (2,2,2) (1,2,3) (1,2,3)	Stack the pages of a print job in sequence when printing multiple copies. Notes: <ul style="list-style-type: none"> • “(1,1,1) (2,2,2)” is the factory default setting. • On stacks the print job in sequence.

Use	To
Separator Sheets Off Between Copies Between Jobs Between Pages	Specify whether blank separator sheets are inserted. Notes: <ul style="list-style-type: none"> • None is the factory default setting. • Between Copies inserts a blank sheet between each copy of a print job if Collate is set to "(1,2,3) (1,2,3)." If Collate is set to "(1,1,1) (2,2,2)," then a blank page is inserted between each set of printed pages, such as after all page 1's and after all page 2's. • Between Jobs inserts a blank sheet between print jobs. • Between Pages inserts a blank sheet between each page of a print job. This setting is useful when printing transparencies or when inserting blank pages in a document.
Separator Source Tray [x] Manual Feeder	Specify the paper source for separator sheets. Notes: <ul style="list-style-type: none"> • Tray 1 (standard tray) is the factory default setting. • From the Paper menu, set Configure MP to "Cassette" for Manual Feeder to appear as a menu setting.
Paper Saver Off 2-Up 3-Up 4-Up 6-Up 9-Up 12-Up 16-Up	Print multiple-page images on one side of a paper. Notes: <ul style="list-style-type: none"> • Off is the factory default setting. • The number selected is the number of page images that will print per side.
Paper Saver Ordering Horizontal Reverse Horizontal Reverse Vertical Vertical	Specify the positioning of multiple-page images when using Paper Saver. Notes: <ul style="list-style-type: none"> • Horizontal is the factory default setting. • Positioning depends on the number of page images and whether they are in portrait or landscape orientation.
Paper Saver Orientation Auto Landscape Portrait	Specify the orientation of a multiple-page document. Note: Auto is the factory default setting. The printer chooses between portrait and landscape.
Paper Saver Border None Solid	Print a border when using Paper Saver. Note: None is the factory default setting.
Staple Job Off On	Specify whether printed output is stapled. Notes: <ul style="list-style-type: none"> • Off is the factory default setting. • This menu item appears only when a supported staple finisher is installed.

Use	To
Run Stapler Test	Print a report that confirms that the stapler finisher is functioning properly. Note: This menu item appears only when a supported stapler finisher is installed.

Quality menu

Use	To
Print Resolution 300 dpi 600 dpi 1200 dpi 1200 Image Q 2400 Image Q	Specify the printed output resolution in dots per inch. Note: 600 dpi is the factory default setting.
Pixel Boost Off Fonts Horizontally Vertically Both directions Isolated	Enable more pixels to print in clusters for clarity, in order to enhance images horizontally or vertically, or to enhance fonts. Note: Off is the factory default setting.
Toner Darkness 1–10	Lighten or darken the printed output. Notes: <ul style="list-style-type: none"> • 8 is the factory default setting. • Selecting a smaller number can help conserve toner.
Enhance Fine Lines On Off	Enable a print mode preferable for files such as architectural drawings, maps, electrical circuit diagrams, and flow charts. Notes: <ul style="list-style-type: none"> • Off is the factory default setting. • You can set this option from the printer software. For Windows users, click File > Print, and then click Properties, Preferences, Options, or Setup. For Macintosh users, choose File > Print, and then adjust the settings from the Print dialog and pop-up menus. • To set this option using the Embedded Web Server, type the network printer IP address in the Web browser address field.
Gray Correction Auto Off	Automatically adjust the contrast enhancement applied to images. Note: Auto is the factory default setting.
Brightness -6 to 6	Adjust the printed output either by lightening or darkening it. You can conserve toner by lightening the output. Note: 0 is the factory default setting.
Contrast 0–5	Adjust the contrast of printed objects. Note: 0 is the factory default setting.

Job Accounting menu

Note: This menu item appears only when a formatted, working printer hard disk is installed. Make sure the printer hard disk is not read/write- or write-protected.

Use	To
Job Accounting Log Off On	Determine and set if the printer creates a log of the print jobs it receives. Note: Off is the factory default setting.
Job Accounting Utilities	Print and delete log files or export them to a flash drive.
Accounting Log Frequency Weekly Monthly	Determine and set how often a log file is created. Note: Monthly is the factory default setting.
Log Action at End of Frequency None E-mail Current Log E-mail & Delete Current Log Post Current Log Post & Delete Current Log	Determine and set how the printer responds when the frequency threshold expires. Note: None is the factory default setting.
Disk Near Full Level Off 1–99	Specify the maximum size of the log file before the printer executes the Disk Near Full Action. Note: 5 is the factory default setting.
Disk Near Full Action None E-mail Current Log E-mail & Delete Current Log E-mail & Delete Oldest Log Post Current Log Post & Delete Current Log Post & Delete Oldest Log Delete Current Log Delete Oldest Log Delete All Logs Delete All But Current	Determine and set how the printer responds when the printer hard disk is nearly full. Notes: <ul style="list-style-type: none"> • None is the factory default setting. • The value defined in Disk Near Full Level determines when this action is triggered.
Disk Full Action None E-mail & Delete Current Log E-mail & Delete Oldest Log Post & Delete Current Log Post & Delete Oldest Log Delete Current Log Delete Oldest Log Delete All Logs Delete All But Current	Determine and set how the printer responds when disk usage reaches the maximum limit (100MB). Note: None is the factory default setting.
URL to Post Logs	Determine and set where the printer posts job accounting logs.

Use	To
E-mail Address to Send Logs	Specify the e-mail address to which the printer sends job accounting logs.
Log File Prefix	Specify the prefix you want for the log file name. Note: The current host name defined in the TCP/IP menu is used as the default log file prefix.

Utilities menu

Use	To
Remove Held Jobs Confidential Held Not Restored All	Delete confidential and held jobs from the printer hard disk. Notes: <ul style="list-style-type: none"> • Selecting a setting affects only print jobs that are resident in the printer. Bookmarks, print jobs on flash drives, and other types of held jobs are not affected. • Not Restored removes all Print and Hold jobs that are <i>not</i> restored from the printer hard disk or memory.
Format Flash Yes No	Format the flash memory. Warning—Potential Damage: Do not turn off the printer while the flash memory is being formatted. Notes: <ul style="list-style-type: none"> • Yes deletes all data stored in flash memory. • No cancels the format request. • Flash memory refers to the memory added by installing a flash memory card in the printer. • The flash memory option card must not be read/write- or write-protected. • This menu item appears only when a non-defective flash memory card is installed.
Delete Downloads on Disk Delete Now Do Not Delete	Delete downloads from the printer hard disk, including all held jobs, buffered jobs, and parked jobs. Notes: <ul style="list-style-type: none"> • Delete Now sets the printer to delete the downloads and allows the display to return to the originating screen after the deletion. • Do Not Delete sets the printer display to return to the main Utilities menu for touch-screen printer models. When selected in non-touch-screen printer models, Do Not Delete sets the printer to return to the originating screen after the deletion.
Activate Hex Trace	Assist in isolating the source of a print job problem. Notes: <ul style="list-style-type: none"> • When activated, all data sent to the printer is printed in hexadecimal and character representation, and control codes are not executed. • To exit or deactivate Hex Trace, turn off or reset the printer.

Use	To
Coverage Estimator Off On	Provide an estimate of the percentage coverage of toner on a page. The estimate is printed on a separate page at the end of each print job. Note: Off is the factory default setting.

XPS menu

Use	To
Print Error Pages Off On	Print a page containing information on errors, including XML markup errors. Note: Off is the factory default setting.

PDF menu

Use	To
Scale to Fit Yes No	Scale page content to fit the selected paper size. Note: No is the factory default setting.
Annotations Do Not Print Print	Print annotations in a PDF. Note: Do Not Print is the factory default setting.

PostScript menu

Use	To
Print PS Error On Off	Print a page containing the PostScript error. Note: Off is the factory default setting.
Lock PS Startup Mode On Off	Disable the SysStart file. Note: Off is the factory default setting.
Font Priority Resident Flash/Disk	Establish the font search order. Notes: <ul style="list-style-type: none"> • Resident is the factory default setting. • This menu item is available only when a formatted flash memory option card or printer hard disk is installed and operating properly. • Make sure the flash memory option or printer hard disk is not read/write-, write-, or password-protected. • Job Buffer Size must not be set to 100%.

PCL Emul menu

Use	To
Font Source Resident Disk Download Flash All	Specify the set of fonts used by the Font Name menu. Notes: <ul style="list-style-type: none"> • “Resident” is the factory default setting. Resident shows the factory default set of fonts downloaded in the RAM. • “Flash” and “Disk” settings show all fonts resident in that option. • The flash option must be properly formatted and cannot be read/write-, write-, or password-protected. • “Download” shows all the fonts downloaded in the RAM. • “All” shows all fonts available to any option.
Font Name Courier 10	Identify a specific font and the option where it is stored. Note: Courier 10 is the factory default setting. Courier 10 shows the font name, font ID, and the storage location in the printer. The font source abbreviation is R for Resident, F for Flash, K for Disk, and D for Download.
Symbol Set 10U PC-8 12U PC-850	Specify the symbol set for each font name. Notes: <ul style="list-style-type: none"> • 10U PC-8 is the US factory default setting. 12U PC-850 is the international factory default setting. • A symbol set is a set of alphabetic and numeric characters, punctuation, and special symbols. Symbol sets support the different languages or specific programs such as math symbols for scientific text. Only the supported symbol sets are shown.
PCL Emulation Settings Point Size 1.00–1008.00	Change the point size for scalable typographic fonts. Notes: <ul style="list-style-type: none"> • 12 is the factory default setting. • Point size refers to the height of the characters in the font. One point equals approximately 0.014 inch. • Point sizes can be increased or decreased in 0.25-point increments.
PCL Emulation Settings Pitch 0.08–100	Specify the font pitch for scalable monospaced fonts. Notes: <ul style="list-style-type: none"> • 10 is the factory default setting. • Pitch refers to the number of fixed-space characters per inch (cpi). • Pitch can be increased or decreased in 0.01-cpi increments. • For nonscalable monospaced fonts, the pitch appears on the display but it cannot be changed.
PCL Emulation Settings Orientation Portrait Landscape	Specify the orientation of text and graphics on the page. Notes: <ul style="list-style-type: none"> • Portrait is the factory default setting. Portrait prints text and graphics parallel to the short edge of the page. • Landscape prints text and graphics parallel to the long edge of the page.

Use	To
PCL Emulation Settings Lines per Page 1–255	Specify the number of lines that print on each page. Notes: <ul style="list-style-type: none"> • 60 is the US factory default setting. 64 is the international default setting. • The printer sets the amount of space between each line based on the Lines per Page, Paper Size, and Orientation settings. Select the Paper Size and Orientation you want before setting Lines per Page.
PCL Emulation Settings A4 Width 198 mm 203 mm	Set the printer to print on A4-size paper. Notes: <ul style="list-style-type: none"> • “198 mm” is the factory default setting. • The 203-mm setting sets the width of the page to allow printing of eighty 10-pitch characters.
PCL Emulation Settings Auto CR after LF On Off	Specify whether the printer automatically performs a carriage return (CR) after a line feed (LF) control command. Note: Off is the factory default setting.
PCL Emulation Settings Auto LF after CR On Off	Specify whether the printer automatically performs a line feed (LF) after a carriage return (CR) control command. Note: Off is the factory default setting.
Tray Renumber Assign MP Feeder Off None 0–199 Assign Tray [x] Off None 0–199 Assign Manual Paper Off None 0–199 Assign Manual Env Off None 0–199	Configure the printer to work with printer software or programs that use different source assignments for trays and feeders. Notes: <ul style="list-style-type: none"> • “Off” is the factory default setting. • “None” ignores the Select Paper Feed command. This option appears only when it is selected by the PCL 5 interpreter. • “0–199” allows a custom setting to be assigned.

Use	To
<p>Tray Renumber</p> <ul style="list-style-type: none"> View Factory Defaults MPF Default = 8 T1 Default = 1 T1 Default = 4 T1 Default = 5 T1 Default = 20 T1 Default = 21 Env Default = 6 MPaper Default = 2 MEnv Default = 3 	<p>Display the factory default setting assigned to each tray or feeder.</p>
<p>Tray Renumber</p> <ul style="list-style-type: none"> Restore Defaults Yes No 	<p>Restore all tray and feeder assignments to the factory default settings.</p>

HTML menu

Use		To
<p>Font Name</p> <ul style="list-style-type: none"> Albertus MT Antique Olive Apple Chancery Arial MT Avant Garde Bodoni Bookman Chicago Clarendon Cooper Black Copperplate Coronet Courier Eurostile Garamond Geneva Gill Sans Goudy Helvetica Hoefler Text Intl CG Times Intl Courier Intl Univers 	<ul style="list-style-type: none"> Joanna MT Letter Gothic Lubalin Graph Marigold MonaLisa Recut Monaco New CenturySbk New York Optima Oxford Palatino StempelGaramond Taffy Times TimesNewRoman Univers Zapf Chancery NewSansMTCS NewSansMTCT New SansMTJA NewSansMTKO 	<p>Set the default font for HTML documents.</p> <p>Note: The Times font is used in HTML documents that do not specify a font.</p>

Use	To
Font Size 1–255 pt	Set the default font size for HTML documents. Notes: <ul style="list-style-type: none"> • 12 pt is the factory default setting. • Font size can be increased in 1-point increments.
Scale 1–400%	Scale the default font for HTML documents. Notes: <ul style="list-style-type: none"> • 100% is the factory default setting. • Scaling can be increased in 1% increments.
Orientation Portrait Landscape	Set the page orientation for HTML documents. Note: Portrait is the factory default setting.
Margin Size 8–255 mm	Set the page margin for HTML documents. Notes: <ul style="list-style-type: none"> • 19 mm is the factory default setting. • Margin size can be increased in 1-mm increments.
Backgrounds Do Not Print Print	Specify whether to print backgrounds on HTML documents. Note: Print is the factory default setting.

Image menu

Use	To
Auto Fit On Off	Select the optimal paper size, scaling, and orientation. Note: On is the factory default setting. It overrides scaling and orientation settings for some images.
Invert On Off	Invert bitonal monochrome images. Notes: <ul style="list-style-type: none"> • Off is the factory default setting. • This setting does not apply to GIF or JPEG images.
Scaling Anchor Top Left Best Fit Anchor Center Fit Height/Width Fit Height Fit Width	Scale the image to fit the selected paper size. Notes: <ul style="list-style-type: none"> • Best Fit is the factory default setting. • When Auto Fit is set to On, Scaling is automatically set to Best Fit.

Use	To
Orientation Portrait Landscape Reverse Portrait Reverse Landscape	Set the image orientation. Note: Portrait is the factory default setting.

Help menu

The Help menu consists of a series of Help pages that are stored in the multifunction printer (MFP) as PDF files. They contain information about using the printer and performing various tasks, including copying, scanning, and faxing.

English, French, German, and Spanish translations are stored in the printer.

Menu item	Description
Print All Guides	Prints all the guides
Copy Guide	Provides information about making copies and changing settings
E-mail Guide	Provides information about sending e-mails using addresses, shortcut numbers, or the address book, and about changing settings
Fax Guide	Provides information about sending faxes using fax numbers, shortcut numbers, or the address book, and about changing settings
FTP Guide	Provides information about scanning documents directly to an FTP server using an FTP address, shortcut numbers, or the address book, and about changing settings
Print Defects Guide	Provides help in resolving repeating defects in copies or prints
Information Guide	Provides help in locating additional information

Saving money and the environment

Saving paper and toner

Studies show that as much as 80% of the carbon footprint of a printer is related to paper usage. You can significantly reduce your carbon footprint by using recycled paper and the following printing suggestions, such as printing on both sides of the paper and printing multiple pages on one side of a single sheet of paper.

For more information on how you can quickly save paper and energy using one printer setting, see [“Using Eco-Mode” on page 200](#).

Conserving supplies

Use both sides of the paper

If your printer model supports two-sided printing, then you can control whether print appears on one or two sides of the paper.

Notes:

- Two-sided printing is the default setting in the print driver.
- For a complete list of supported products and countries, go to www.dell.com/support.

Place multiple pages on one sheet of paper

You can print up to 16 consecutive pages of a multiple-page document onto one side of a single sheet of paper by setting multiple page printing (N-Up) for the print job.

Check your first draft for accuracy

Before printing or making multiple copies of a document:

- Use the preview feature to see how the document looks like before you print it.
- Print one copy of the document to check its content and format for accuracy.

Avoid paper jams

Correctly set the paper type and size to avoid paper jams. For more information, see [“Avoiding jams” on page 224](#).

Saving energy

Using Eco-Mode

- 1 Open a Web browser, and then type the printer IP address in the address field.

Notes:

- View the printer IP address on the printer home screen. The IP address appears as four sets of numbers separated by periods, such as 123.123.123.123.
- If you are using a proxy server, then temporarily disable it to load the Web page correctly.

2 Click **Settings > General Settings > Eco-Mode >** select a setting

Use	To
Off	Use the factory default settings for all settings associated with Eco-Mode. Off supports the performance specifications of the printer.
Energy	Reduce energy use, especially when the printer is idle. <ul style="list-style-type: none"> • Printer engine motors do not start until it is ready to print. You may notice a short delay before the first page is printed. • The printer enters Sleep mode after one minute of inactivity.
Energy/Paper	Use all the settings associated with Energy and Paper modes.
Plain Paper	<ul style="list-style-type: none"> • Enable the automatic two-sided (duplex) feature. • Turn off print log features.

3 Click **Submit**.

Reducing printer noise

Enable Quiet Mode to reduce printer noise.

1 Open a Web browser, and then type the printer IP address in the address field.**Notes:**

- View the printer IP address on the printer home screen. The IP address appears as four sets of numbers separated by periods, such as 123.123.123.123.
- If you are using a proxy server, then temporarily disable it to load the Web page correctly.

2 Click **Settings > General Settings > Quiet Mode >** select a setting

Use	To
On	Reduce printer noise. Notes: <ul style="list-style-type: none"> • Print jobs are processed at a reduced speed. • Printer engine motors do not start until a document is ready to print. There will be a short delay before the first page is printed.
Off	Use factory default settings. Note: This setting supports the performance specifications of the printer.

3 Click **Submit**.

Adjusting Sleep mode

To save energy, decrease the number of minutes the printer waits before it enters Sleep mode.

Available settings range from 1–180 minutes. The factory default setting is 30 minutes.

Using the Embedded Web Server

- 1 Open a Web browser, and then type the printer IP address in the address field.

Notes:

- View the printer IP address on the printer home screen. The IP address appears as four sets of numbers separated by periods, such as 123.123.123.123.
- If you are using a proxy server, then temporarily disable it to load the Web page correctly.

- 2 Click **Settings** > **General Settings** > **Timeouts**.

- 3 In the Sleep Mode field, enter the number of minutes you want for the printer to wait before it enters Sleep Mode.

- 4 Click **Submit**.

Using the printer control panel

- 1 From the home screen, navigate to:



> **Settings** > **General Settings** > **Timeouts** > **Sleep Mode**

- 2 In the Sleep Mode field, select the number of minutes you want for the printer to wait before it enters Sleep Mode.

- 3 Touch .

Using Hibernate mode

Hibernate is an ultra-low-power operating mode.

Notes:

- Three days is the default amount of time before the printer enters Hibernate mode.
- Make sure to wake the printer from Hibernate mode before sending a print job. A hard reset or a long press of the Sleep button wakes the printer from Hibernate mode.
- If the printer is in Hibernate mode, then the Embedded Web Server is disabled.

- 1 From the home screen, navigate to:



> **Settings** > **General Settings**

- 2 From the “Press Sleep Button” or “Press and Hold Sleep Button” menu, select **Hibernate**, and then touch **Submit**.

Setting Hibernate Timeout

Hibernate Timeout lets you set the amount of time the printer waits after a print job is processed before it goes into a reduced power state.

Using the Embedded Web Server

- 1 Open a Web browser, and then type the printer IP address in the address field.

Notes:

- View the printer IP address on the printer home screen. The IP address appears as four sets of numbers separated by periods, such as 123.123.123.123.
- If you are using a proxy server, then temporarily disable it to load the Web page correctly.

- 2 Click **Settings** > **General Settings** > **Timeouts**.

- 3 From the Hibernate Timeout menu, select the number of hours, days, weeks, or months you want for the printer to wait before it goes into a reduced power state.

- 4 Click **Submit**.

Using the printer control panel

- 1 From the printer control panel, navigate to:



> **Settings** > **General Settings** > **Timeouts** > **Hibernate Timeout**

- 2 Select the amount of time the printer waits after a print job is processed before it enters Hibernate mode.

- 3 Touch .

Using Schedule Power Modes

Schedule Power Modes lets you schedule when the printer goes into a reduced power state or into Ready state.

Note: This feature is available only in network printers or printers connected to print servers.

Using the Embedded Web Server

- 1 Open a Web browser, and then type the printer IP address in the address field.

Notes:

- View the printer IP address on the printer home screen. The IP address appears as four sets of numbers separated by periods, such as 123.123.123.123.
- If you are using a proxy server, then temporarily disable it to load the Web page correctly.

- 2 Click **Settings** > **General Settings** > **Schedule Power Modes**.

- 3 From the Action menu, select the power mode.

- 4 From the Time menu, select the time.

- 5 From the Day(s) menu, select the day or days.

- 6 Click **Add**.

Adjusting the brightness of the display

To save energy, or if you are have trouble reading your display, adjust the brightness of the display.

Available settings range from 20–100. The factory default setting is 100.

Using the Embedded Web Server

- 1 Open a Web browser, and then type the printer IP address in the address field.

Notes:

- View the printer IP address on the home screen. The IP address appears as four sets of numbers separated by periods, such as 123.123.123.123.
- If you are using a proxy server, then temporarily disable it to load the Web page correctly.

- 2 Click **Settings** > **General Settings**.

- 3 In the Screen Brightness field, enter the brightness percentage you want for the display.

- 4 Click **Submit**.

Using the printer control panel

- 1 From the home screen, navigate to:



> **Settings** > **General Settings** > **Screen Brightness**

- 2 In the Screen Brightness field, enter the brightness percentage you want for the display.

- 3 Touch .

Recycling

Recycling Dell products

To return Dell products for recycling:

- 1 Visit our Web site at www.dell.com/recycle.
- 2 Select your country or region.
- 3 Follow the instructions on the computer screen.

Securing the printer

Statement of Volatility

Your printer contains various types of memory that can store device and network settings, and user data.

Types of memory	Description
Volatile memory	Your printer uses standard <i>Random Access Memory</i> (RAM) to temporarily buffer user data during simple print and copy jobs.
Non-volatile memory	Your printer may use two forms of non-volatile memory: EEPROM and NAND (flash memory). Both types are used to store the operating system, device settings, network information, scanner and bookmark settings, and embedded solutions.
Hard disk memory	Some printers have a hard disk drive installed. The printer hard disk is designed for device-specific functionality. This lets the device retain buffered user data from complex scan, print, copy, and fax jobs, as well as form data, and font data.

Erase the content of any installed printer memory in the following circumstances:

- The printer is being decommissioned.
- The printer hard disk is being replaced.
- The printer is being moved to a different department or location.
- The printer is being serviced by someone from outside your organization.
- The printer is being removed from your premises for service.
- The printer is being sold to another organization.

Disposing of a printer hard disk

Note: Some printer models may not have a printer hard disk installed.

In high-security environments, it may be necessary to take additional steps to make sure that confidential data stored in the printer hard disk cannot be accessed when the printer—or its hard disk—is removed from your premises.

- **Degaussing**—Flushes the hard disk with a magnetic field that erases stored data
- **Crushing**—Physically compresses the hard disk to break component parts and render them unreadable
- **Milling**—Physically shreds the hard disk into small metal bits

Note: Most data can be erased electronically, but the only way to guarantee that all data is completely erased is to physically destroy each hard disk where data is stored.

Erasing volatile memory

The volatile memory (RAM) installed in your printer requires a power source to retain information. To erase the buffered data, simply turn off the printer.

Erasing non-volatile memory

- **Individual settings, device and network settings, security settings, and embedded solutions**—Erase information and settings by selecting **Wipe All Settings** in the Configuration menu.
- **Fax data**—Erase fax settings and data by selecting **Wipe All Settings** in the Configuration menu.

1 Turn off the printer.

2 Hold down **2** and **6** while turning the printer on. Release the buttons only when the screen with the progress bar appears.

The printer performs a power-on sequence, and then the Configuration menu appears. When the printer is fully powered up, the touch screen displays a list of functions, instead of the standard home screen icons.

3 Touch **Wipe All Settings**.

The printer will restart several times during this process.

Note: Wipe All Settings securely removes device settings, solutions, jobs, faxes, and passwords from the printer memory.

4 Touch **Back > Exit Config Menu**.

The printer will perform a power-on reset, and then return to normal operating mode.

Erasing printer hard disk memory

Notes:

- Some printer models may not have a printer hard disk installed.
- Configuring Erase Temporary Data Files in the printer menus lets you remove residual confidential material left by print jobs by securely overwriting files that have been marked for deletion.

Using the printer control panel

1 Turn off the printer.

2 Hold down **2** and **6** while turning the printer on. Release the buttons only when the screen with the progress bar appears.

The printer performs a power-on sequence, and then the Configuration menu appears. When the printer is fully turned on, the touch screen displays a list of functions.

3 Touch **Wipe Disk**, and then touch one of the following:

- **Wipe disk (fast)**—This lets you overwrite the disk with all zeroes in a single pass.
- **Wipe disk (secure)**—This lets you overwrite the disk with random bit patterns several times, followed by a verification pass. A secure overwrite is compliant with the DoD 5220.22-M standard for securely erasing data from a hard disk. Highly confidential information should be wiped using this method.

4 Touch **Yes** to proceed with disk wiping.

Notes:

- A status bar will indicate the progress of the disk wiping task.

- Disk wiping can take from several minutes to more than an hour, during which the printer will be unavailable for other user tasks.

5 Touch **Back** > **Exit Config Menu**.

The printer will perform a power-on reset, and then return to normal operating mode.

Configuring printer hard disk encryption

Enable hard disk encryption to prevent loss of sensitive data in the event the printer or its hard disk is stolen.

Note: Some printer models may not have a printer hard disk installed.

Using the Embedded Web Server

1 Open a Web browser, and then type the printer IP address in the address field.

Notes:

- View the printer IP address on the printer home screen. The IP address appears as four sets of numbers separated by periods, such as 123.123.123.123.
- If you are using a proxy server, then temporarily disable it to load the Web page correctly.

2 Click **Settings** > **Security** > **Disk Encryption**.

Note: Disk Encryption appears in the Security Menu only when a formatted, non-defective printer hard disk is installed.

3 From the Disk encryption menu, select **Enable**.

Notes:

- Enabling disk encryption will erase the contents of the printer hard disk.
- Disk encryption can take from several minutes to more than an hour, during which the printer will be unavailable for other user tasks.

4 Click **Submit**.

Using the printer control panel

1 Turn off the printer.

2 Hold down **2** and **6** while turning the printer on. Release the buttons only when the screen with the progress bar appears.

The printer performs a power-on sequence, and then the Configuration menu appears. When the printer is fully turned on, a list of functions appears on the printer display.

3 Touch **Disk Encryption** > **Enable**.

Note: Enabling disk encryption will erase the contents of the printer hard disk.

4 Touch **Yes** to proceed with disk wiping.

Notes:

- Do not turn off the printer during the encryption process. Doing so may result in loss of data.
- Disk encryption can take from several minutes to more than an hour, during which the printer will be unavailable for other user tasks.

- A status bar will indicate the progress of the disk wiping task. After the disk has been encrypted, the printer will return to the Enable/Disable screen.

5 Touch **Back > Exit Config Menu**.

The printer will perform a power-on reset, and then return to normal operating mode.

Finding printer security information

In high-security environments, you may need to take additional steps to make sure that confidential data stored in the printer cannot be accessed by unauthorized persons. For more information, check the *Embedded Web Server—Security: Administrator's Guide* from your printer CD or from our Web site, or contact the place where you purchased the printer.

Maintaining the printer

Warning—Potential Damage: Failure to maintain optimum printer performance, or to replace parts and supplies, may cause damage to your printer.

Cleaning printer parts

Cleaning the printer

Note: You may need to perform this task after every few months.

Warning—Potential Damage: Damage to the printer caused by improper handling is not covered by the printer warranty.

- 1 Make sure that the printer is turned off and unplugged from the electrical outlet.



CAUTION—SHOCK HAZARD: To avoid the risk of electrical shock when cleaning the exterior of the printer, unplug the power cord from the electrical outlet and disconnect all cables from the printer before proceeding.

- 2 Remove paper from the standard bin and multipurpose feeder.
- 3 Remove any dust, lint, and pieces of paper around the printer using a soft brush or vacuum.
- 4 Dampen a clean, lint-free cloth with water, and use it to wipe the outside of the printer.

Warning—Potential Damage: Do not use household cleaners or detergents to prevent damage to the exterior of the printer.

- 5 Make sure all areas of the printer are dry before sending a new print job.

Cleaning the scanner glass

Clean the scanner glass if you encounter print quality problems, such as streaks on copied or scanned images.

- 1 Slightly dampen a soft, lint-free cloth or paper towel with water.
- 2 Open the scanner cover.



- 3 Clean all the areas shown, and then let them dry.



1	White underside of the scanner cover
2	Scanner glass
3	ADF glass
4	White underside of the ADF cover

- 4 Close the scanner cover.

Checking the status of parts and supplies

Checking the status of parts and supplies on the printer control panel

From the home screen, touch **Status/Supplies** > **View Supplies**.

Checking the status of parts and supplies from the Embedded Web Server

Note: Make sure the computer and the printer are connected to the same network.

- 1 Open a Web browser, and then type the printer IP address in the address field.

Notes:

- View the printer IP address on the home screen. The IP address appears as four sets of numbers separated by periods, such as 123.123.123.123.
- If you are using a proxy server, then temporarily disable it to load the Web page correctly.

- 2 Click **Device Status** > **More Details**.

Estimated number of remaining pages

The estimated number of remaining pages is based on the recent printing history of the printer. Its accuracy may vary significantly and is dependent on many factors, such as actual document content, print quality settings, and other printer settings.

The accuracy of the estimated number of remaining pages may decrease when the actual printing consumption is different from the historical printing consumption. Consider the variable level of accuracy before purchasing or replacing supplies based on the estimate. Until an adequate print history is obtained on the printer, initial estimates assume future supplies consumption based on the International Organization for Standardization* test methods and page content.

* Average continuous black declared cartridge yield in accordance with ISO/IEC 19752.

Ordering supplies

Ordering supplies using the Supplies Ordering Utility

- 1 Use the Search command on the Start menu to locate Status Monitor Center.
- 2 Open the application, and then click **Order Supplies**.

Ordering supplies using Printer Home

- 1 Use the Search command on the Start menu to locate Dell Printer Home.
- 2 Open the application, and then click **Maintenance** > **Order supplies**.

Ordering toner cartridges

To order toner cartridges, contact the place where you purchased the printer.

Ordering an imaging unit

To order an imaging unit, contact the place where you purchased the printer.

Ordering a maintenance kit

To order a maintenance kit, contact the place where you purchased the printer.

Ordering an ADF separator roller

Order an ADF separator roller when the ADF fails to pick paper or picks more than one sheet of paper at a time.

For information on replacing the ADF separator roller, see the instruction sheet that came with the part.

Storing supplies

Choose a cool, clean storage area for the printer supplies. Store supplies right side up in their original packing until you are ready to use them.

Do not expose supplies to:

- Direct sunlight
- Temperatures above 35°C (95°F)
- High humidity above 80%
- Salty air
- Corrosive gases
- Heavy dust

Replacing supplies

Replacing the toner cartridge

- 1 Press the button on the right side of the printer, and then open the front door.

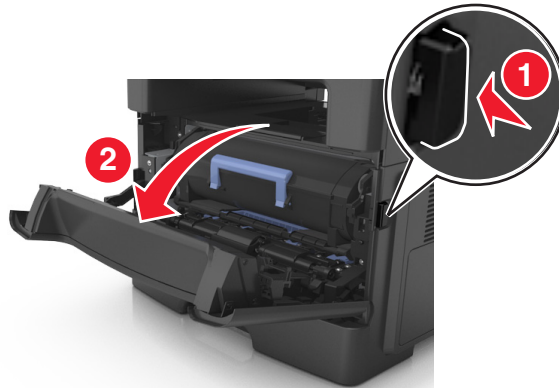

- 2 Pull the toner cartridge out using the handle.



- 3 Unpack the toner cartridge, and then remove all packing materials.
- 4 Shake the new cartridge to redistribute the toner.

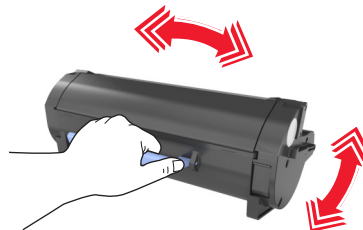

- 5 Insert the toner cartridge into the printer by aligning the side rails of the cartridge with the arrows on the side rails inside the printer.

Warning—Potential Damage: Do not expose the imaging unit to direct light for more than 10 minutes. Extended exposure to light may cause print quality problems.

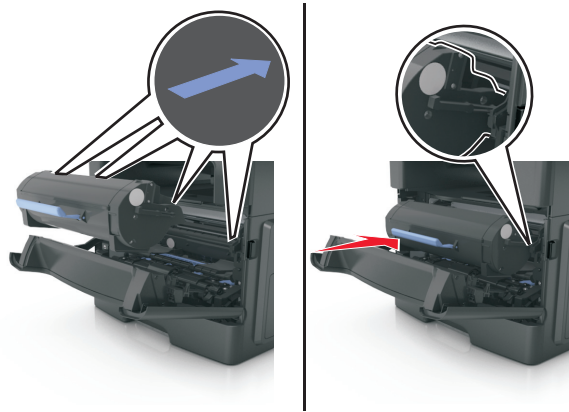

6 Close the front door.

Replacing the imaging unit

1 Press the button on the right side of the printer, and then open the front door.

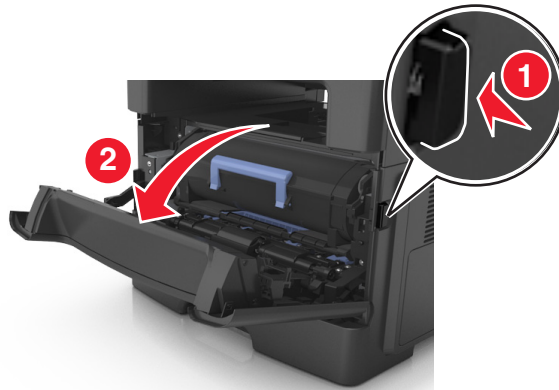

2 Pull the toner cartridge out using the handle.



- 3 Lift the blue handle, and then pull the imaging unit out of the printer.

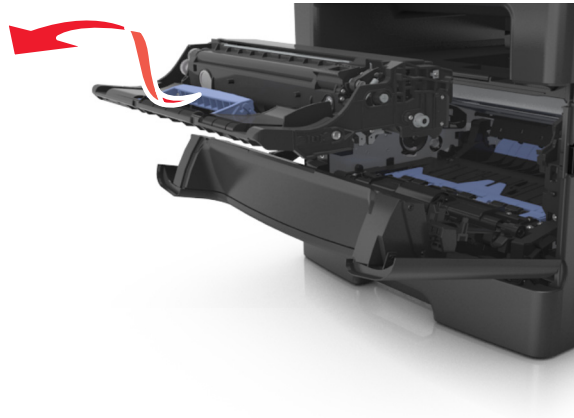

- 4 Unpack the new imaging unit, and then shake it.

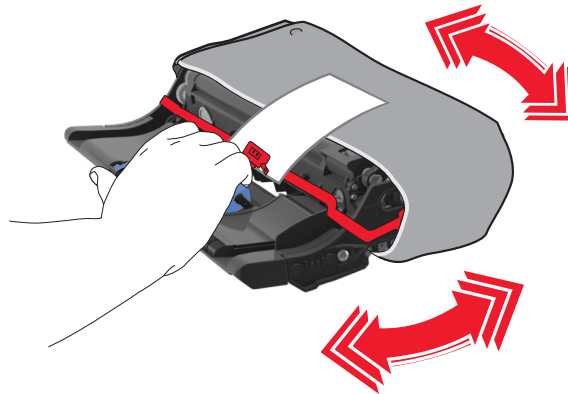

- 5 Remove all packing materials from the imaging unit.

Warning—Potential Damage: Do not expose the imaging unit to direct light for more than 10 minutes. Extended exposure to light may cause print quality problems.

Warning—Potential Damage: Do not touch the photoconductor drum. Doing so may affect the print quality of future print jobs.

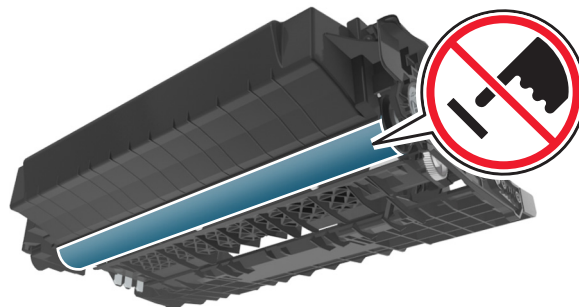

- 6 Insert the imaging unit into the printer by aligning the arrows on the side rails of the imaging unit with the arrows on the side rails inside the printer.

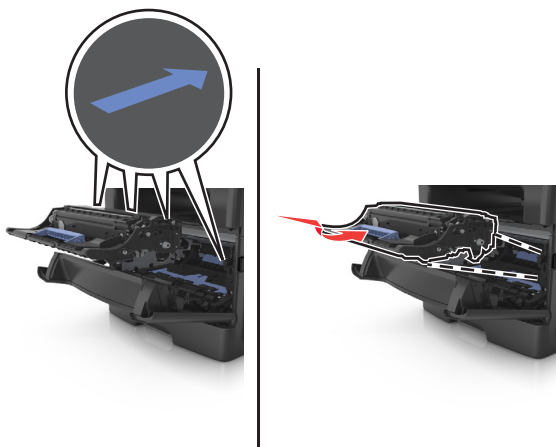

- 7 Insert the toner cartridge into the printer by aligning the side rails of the cartridge with the arrows on the side rails inside the printer.

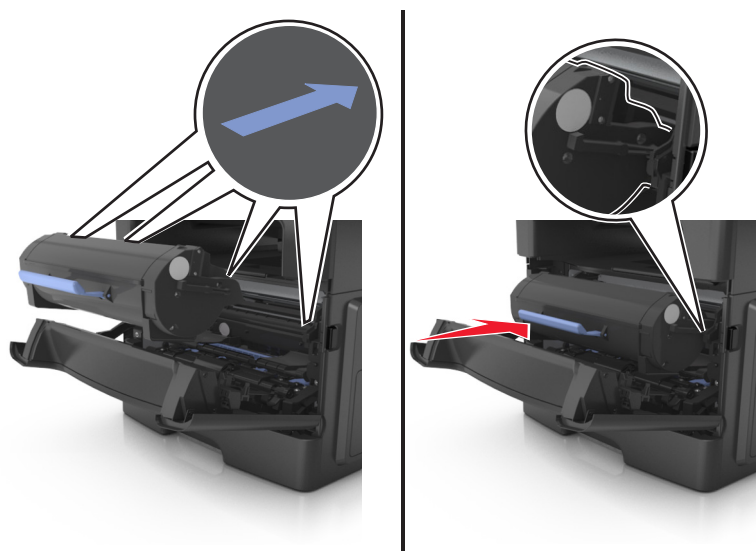

- 8 Close the front door.

Replacing the staple cartridge

- 1 Open the stapler door.

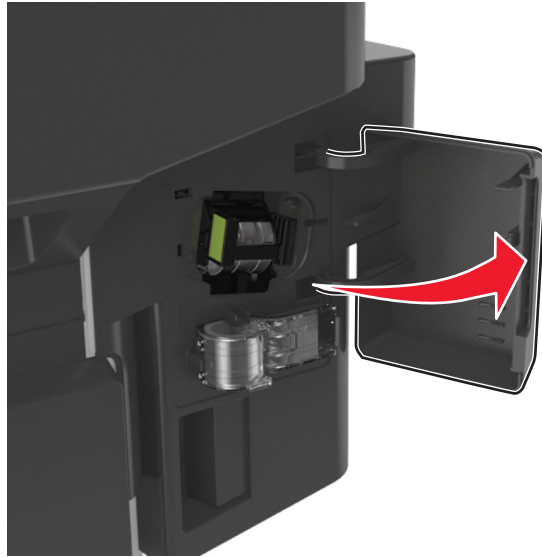

- 2 Pull out the staple cartridge from the finisher.

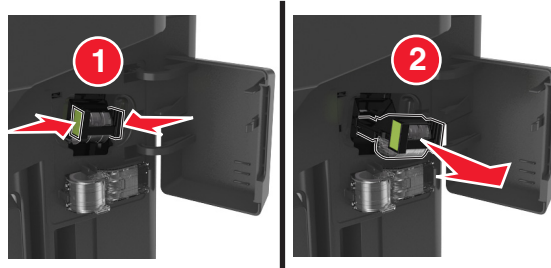

- 3 Hold both sides of the empty staple case with your fingers, pull, and then lift the empty staple case from the cartridge.

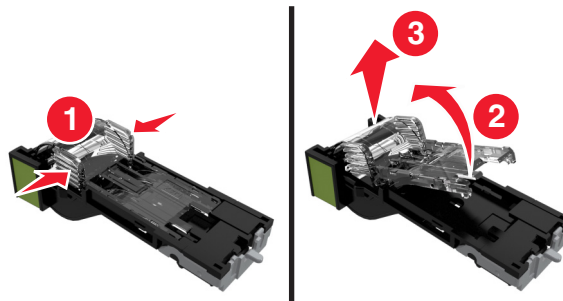

4 Remove the spare staple case from its holder.

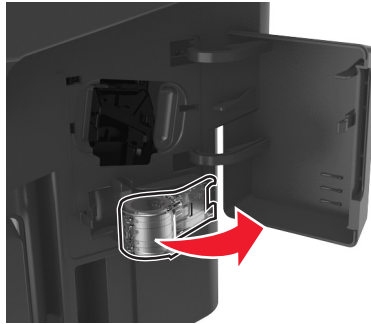

5 Insert the spare staple case into the staple cartridge.

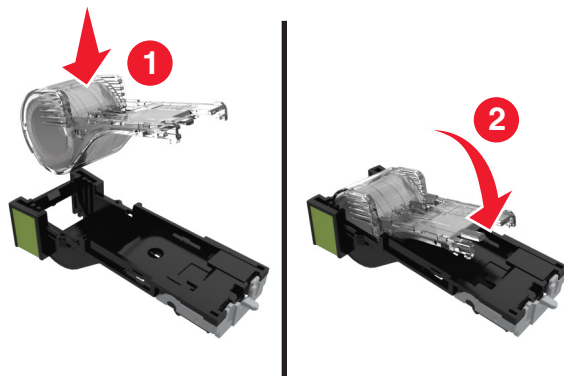

6 Push the staple cartridge into the finisher until it *clicks* into place.

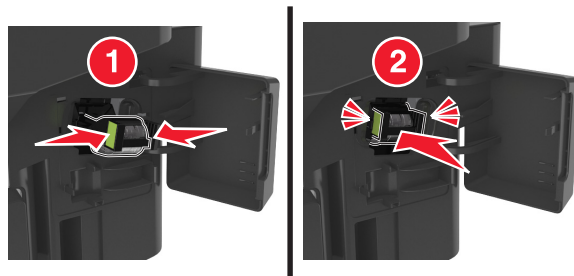

7 Replace the spare staple case for future use.

8 Close the stapler door.

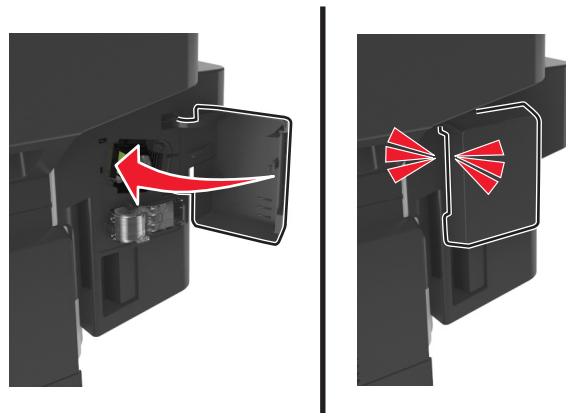

Moving the printer

Before moving the printer

⚠ CAUTION—POTENTIAL INJURY: The printer weight is greater than 18 kg (40 lb) and requires two or more trained personnel to lift it safely.

⚠ CAUTION—POTENTIAL INJURY: Before moving the printer, follow these guidelines to avoid personal injury or printer damage:

- Turn the printer off using the power switch, and then unplug the power cord from the electrical outlet.
- Disconnect all cords and cables from the printer before moving it.
- If an optional tray is installed, then remove it from the printer. To remove the optional tray, slide the latch on the right side of the tray toward the front of the tray until it *clicks* into place.



- Use the handholds located on both sides of the printer to lift it.
- Make sure your fingers are not under the printer when you set it down.
- Before setting up the printer, make sure there is adequate clearance around it.

Use only the power cord provided with this product or the manufacturer's authorized replacement.

Warning—Potential Damage: Damage to the printer caused by improper moving is not covered by the printer warranty.

Moving the printer to another location

The printer and its hardware options can be safely moved to another location by following these precautions:

- Any cart used to move the printer must have a surface able to support the full footprint of the printer.
- Any cart used to move the hardware options must have a surface able to support the dimensions of the hardware options.
- Keep the printer in an upright position.
- Avoid severe jarring movements.

Shipping the printer

When shipping the printer, use the original packaging or call the place of purchase for a relocation kit.

Managing the printer

Managing printer messages

Use the Status Messenger application to view error messages requiring your intervention on your printer. When there is an error, a bubble appears telling you what the error is, and points you to the appropriate recovery information.

If you installed Status Messenger with your printer software, then the application launches automatically when the software installation is completed. The installation is successful if you see the Status Messenger icon in the system tray.

Notes:

- This feature is available only in Windows XP or later.
- Make sure bidirectional communication support is in place so the printer and the computer can communicate.

Disabling Status Messenger

- 1 From the system tray, right-click the Status Messenger icon.
- 2 Select **Exit**.

Enabling Status Messenger

- 1 Use the Search command on the Start menu to locate Status Messenger.
- 2 Open the application.

Accessing Status Monitor Center

Use this application to view the status of any USB- or network-connected printer and to order supplies online.

Note: Make sure bidirectional communication support is in place so the printer and the computer can communicate.

- 1 Use the Search command on the Start menu to locate Status Monitor Center.
- 2 Open the application.

Checking the virtual display

- 1 Open a Web browser, and then type the printer IP address in the address field.

Notes:

- View the printer IP address in the TCP/IP section in the Network/Ports menu. The IP address appears as four sets of numbers separated by periods, such as 123.123.123.123.
 - If you are using a proxy server, then temporarily disable it to load the Web page correctly.
- 2 Check the virtual display that appears at the top left corner of the screen.
The virtual display works as an actual display would work on a printer control panel.

Setting up e-mail alerts

Configure the printer to send you e-mail alerts when the supplies are getting low or when the paper needs to be changed or added, or when there is a paper jam.

- 1 Open a Web browser, and then type the printer IP address in the address field.

Notes:

- View the printer IP address on the printer home screen. The IP address appears as four sets of numbers separated by periods, such as 123.123.123.123.
- If you are using a proxy server, then temporarily disable it to load the Web page correctly.

- 2 Click **Settings**.

- 3 From the Other Settings menu, click **E-mail Alert Setup**.

- 4 Select the items you want to be notified on, and then type the e-mail addresses.

- 5 Click **Submit**.

Note: For information on setting up the e-mail server, contact your system support person.

Viewing reports

You can view some reports from the Embedded Web Server. These reports are useful for assessing the status of the printer, network, and supplies.

- 1 Open a Web browser, and then type the printer IP address in the address field.

Notes:

- View the printer IP address on the printer home screen. The IP address appears as four sets of numbers separated by periods, such as 123.123.123.123.
- If you are using a proxy server, then temporarily disable it to load the Web page correctly.

- 2 Click **Reports**, and then click the type of report you want to view.

Configuring supply notifications from the Embedded Web Server

You can determine how you would like to be notified when supplies run nearly low, low, very low, or reach their end-of-life by setting the selectable alerts.

Notes:

- Selectable alerts can be set on the toner cartridge, imaging unit, and maintenance kit.
- All selectable alerts can be set for nearly low, low, and very low supply conditions. Not all selectable alerts can be set for the end-of-life supply condition. E-mail selectable alert is available for all supply conditions.
- The percentage of estimated remaining supply that prompts the alert can be set on some supplies for some supply conditions.

- 1 Open a Web browser, and then type the printer IP address in the address field.

Notes:

- View the printer IP address on the printer home screen. The IP address appears as four sets of numbers separated by periods, such as 123.123.123.123.
- If you are using a proxy server, then temporarily disable it to load the Web page correctly.

2 Click **Settings > Print Settings > Supply Notifications**.

3 From the drop-down menu for each supply, select one of the following notification options:

Notification	Description
Off	The normal printer behavior for all supplies occurs.
E-mail Only	The printer generates an e-mail when the supply condition is reached. The status of the supply appears on the menus page and status page.
Warning	The printer displays the warning message and generates an e-mail about the status of the supply. The printer does not stop when the supply condition is reached.
Continuable Stop ¹	The printer stops processing jobs when the supply condition is reached, and the user needs to press a button to continue printing.
Non Continuable Stop ^{1,2}	The printer stops processing jobs when the supply condition is reached. The supply must be replaced to continue printing.
¹ The printer generates an e-mail about the status of the supply when supply notification is enabled. ² The printer stops when some supplies become empty to prevent damage.	

4 Click **Submit**.

Restoring factory default settings

If you want to keep a list of the current menu settings for reference, then print a menu settings page before restoring the factory default settings. For more information, see [“Printing a menu settings page” on page 50](#).

If you want a more comprehensive method of restoring the printer factory default settings, then perform the Wipe All Settings option. For more information, see [“Erasing non-volatile memory” on page 206](#).

Warning—Potential Damage: Restoring factory defaults returns most printer settings to the original factory default settings. Exceptions include the display language, custom sizes and messages, and network/port menu settings. All downloads stored in the RAM are deleted. Downloads stored in the flash memory or in a printer hard disk are not affected.

From the home screen, navigate to:

 > **Settings > General Settings > Factory Defaults > Restore Now** > 

Clearing jams

Jam error messages appear on the printer display and include the area of the printer where the jam occurred. When there is more than one jam, the number of jammed pages is displayed.

Avoiding jams

Load paper properly

- Make sure paper lies flat in the tray.

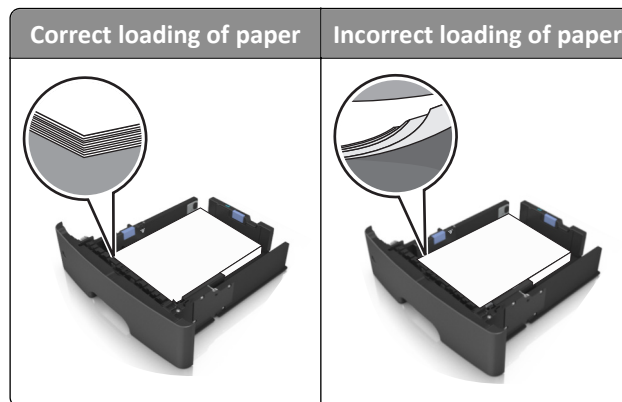

- Do not remove a tray while the printer is printing.
- Do not load a tray while the printer is printing. Load it before printing, or wait for a prompt to load it.
- Do not load too much paper. Make sure the stack height is below the maximum paper fill indicator.
- Do not slide the paper into the tray. Load paper as shown in the illustration.

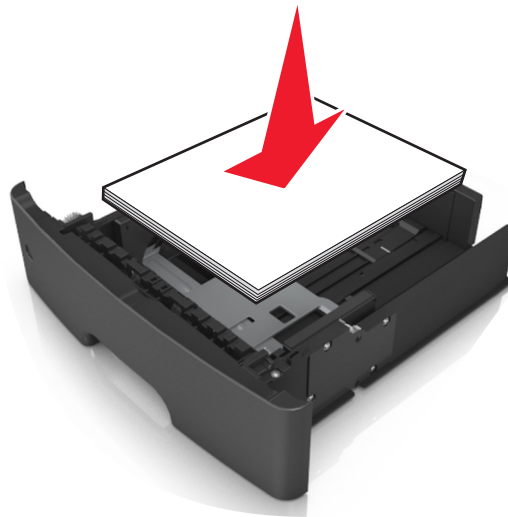

- Make sure the guides in the tray or the multipurpose feeder are properly positioned and are not pressing tightly against the paper or envelopes.
- Push the tray firmly into the printer after loading paper.

Use recommended paper

- Use only recommended paper or specialty media.
- Do not load wrinkled, creased, damp, bent, or curled paper.
- Flex, fan, and straighten paper before loading it.

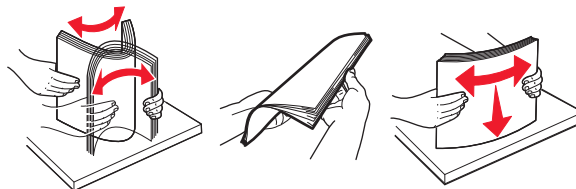

- Do not use paper that has been cut or trimmed by hand.
- Do not mix paper sizes, weights, or types in the same tray.
- Make sure the paper size and type are set correctly on the computer or printer control panel.
- Store paper according to manufacturer recommendations.

Understanding jam messages and locations

When a jam occurs, a message indicating the jam location and information to clear the jam appears on the printer display. Open the doors, covers, and trays indicated on the display to remove the jam.

Notes:

- When Jam Assist is set to On, the printer automatically flushes blank pages or pages with partial prints to the standard bin after a jammed page has been cleared. Check your printed output stack for discarded pages.
- When Jam Recovery is set to On or Auto, the printer reprints jammed pages. However, the Auto setting does not guarantee that the page will print.

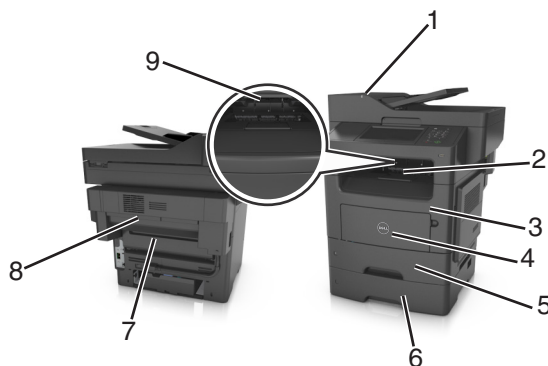

	Jam access area	Printer control panel message	What to do
1	Automatic document feeder (ADF)	[x]-page jam, open ADF to clear jam. [28y.xx]	Remove all paper from the ADF tray, and then remove the jammed paper.
2	Standard bin	[x]-page jam, clear standard bin. [20y.xx]	Remove the jammed paper.
3	Front door	[x]-page jam, open front door. [20y.xx]	Open the front door, then remove the toner cartridge and imaging unit, and then the jammed paper.

	Jam access area	Printer control panel message	What to do
4	Multipurpose feeder	[x]-page jam, clear manual feeder. [25y.xx]	Remove all paper from the multipurpose feeder, and then remove the jammed paper.
5	Tray 1	[x]-page jam, remove tray 1 to clear duplex. [23y.xx]	Pull out tray 1 completely, then push the front duplex flap down, and then remove the jammed paper. Note: You may need to open the rear door to clear some 23y.xx paper jams.
6	Tray [x]	[x]-page jam, open tray [x]. [24y.xx]	Pull the indicated tray out, and then remove the jammed paper.
7	Rear door	[x]-page jam, open rear door. [20y.xx]	Open the rear door, and then remove the jammed paper.
8	Finisher rear door	[x]-page jam, remove all pages from the finisher's output bin. Leave paper in bin [45y.xx]	<ul style="list-style-type: none"> • Open the finisher rear door, and then remove the jammed paper. • Open the narrow door, and then remove the jammed paper.
9	Finisher output bin	[x]-page jam, remove all pages from the output bin. Leave paper in bin [45y.xx]	<ul style="list-style-type: none"> • Move the left paper guide to the left and the right paper guide to the right, and then remove the jammed paper from the finisher bin. • Open the finisher rear door and the narrow door, and then remove any jammed pages.

[x]-page jam, open automatic feeder top cover. [28y.xx]

- 1 Remove all original documents from the ADF tray.

Note: The message is cleared when the pages are removed from the ADF tray.

- 2 Open the ADF cover.

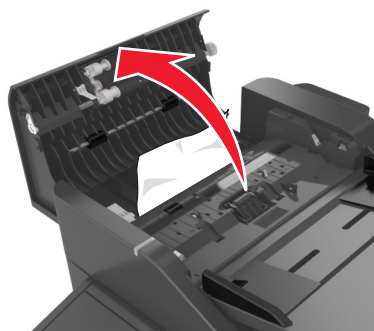

- 3 Firmly grasp the jammed paper on each side, and then gently pull it out.

Note: Make sure all paper fragments are removed.

- 4 Close the ADF cover.

- 5 Straighten the edges of the original documents, then load the documents into the ADF, and then adjust the paper guide.

- 6 From the printer control panel, touch **Done** to clear the message and continue printing.

[x]-page jam, clear standard bin. [20y.xx]

- 1 Firmly grasp the jammed paper on each side, and then gently pull it out.

Note: Make sure all paper fragments are removed.



- 2 From the printer control panel, touch **Done** to clear the message and continue printing.

[x]-page jam, open rear door. [20y.xx]

- 1 Open the front door to loosen the jammed paper in the rear door.

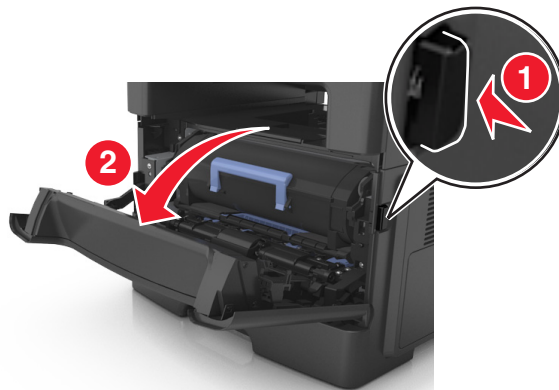

- 2 Gently pull down the rear door.



CAUTION—HOT SURFACE: The inside of the printer might be hot. To reduce the risk of injury from a hot component, allow the surface to cool before touching it.

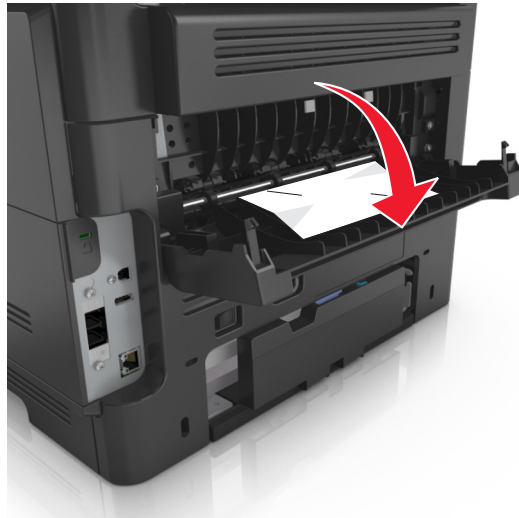

3 Firmly grasp the jammed paper on each side, and then gently pull it out.

Note: Make sure all paper fragments are removed.



4 Close the front and rear door.

5 From the printer control panel, select **Done** to clear the message and continue printing.

[x]-page jam, open front door. [20y.xx]

 **CAUTION—HOT SURFACE:** The inside of the printer might be hot. To reduce the risk of injury from a hot component, allow the surface to cool before touching it.

- 1 Press the button on the right side of the printer, and then open the front door.

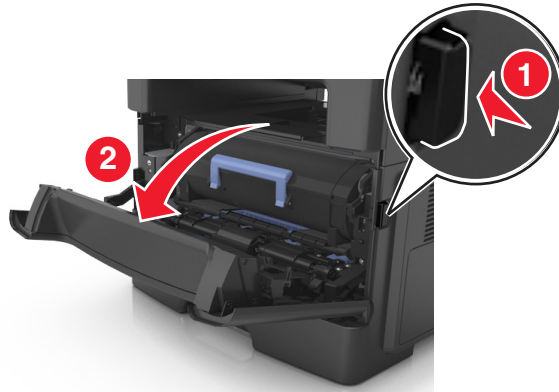

- 2 Pull out the toner cartridge using the handle.



- 3 Lift the blue handle, and then pull out the imaging unit from the printer.

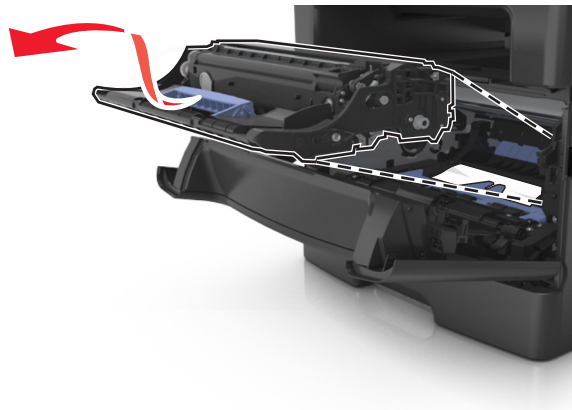

Warning—Potential Damage: Do not touch the shiny blue photoconductor drum under the imaging unit. Doing so may affect the quality of future print jobs.

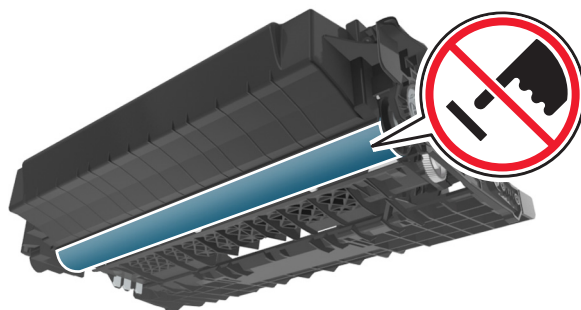

- 4 Place the imaging unit aside on a flat, smooth surface.

Warning—Potential Damage: Do not expose the imaging unit to direct light for more than 10 minutes. Extended exposure to light may cause print quality problems.

- 5 Lift the blue flap in front of the printer.

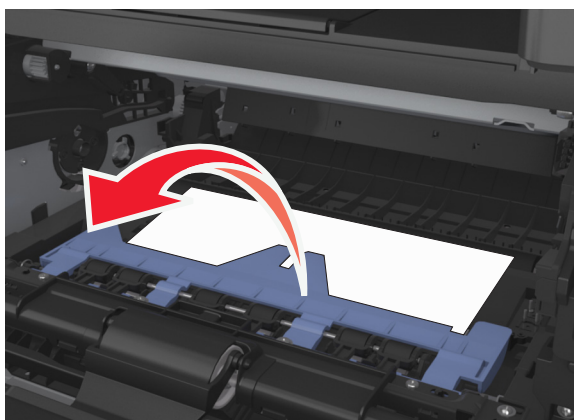

- 6 Firmly grasp the jammed paper on each side, and then gently pull it out.

Note: Make sure all paper fragments are removed.

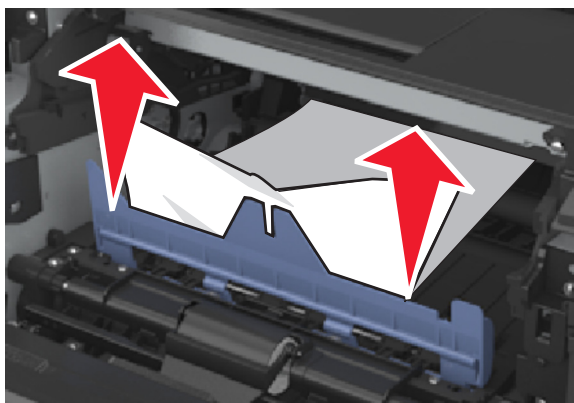

- 7** Insert the imaging unit by aligning the arrows on the side rails of the unit with the arrows on the side rails inside the printer, and then insert the imaging unit into the printer.

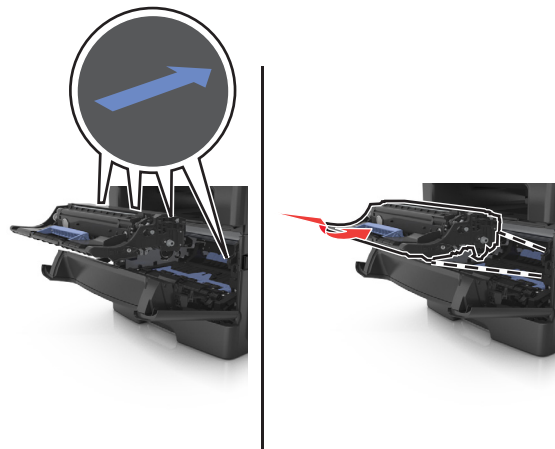

- 8** Insert the toner cartridge by aligning the side rails of the cartridge with the arrows on the side rails inside the printer, and then insert the cartridge into the printer.

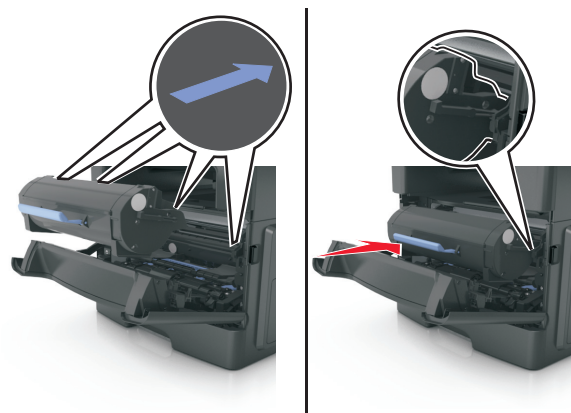

- 9** Close the front door.
- 10** From the printer control panel, select **Continue** to clear the message and continue printing.

[x]-page jam, remove tray 1 to clear duplex. [23y.xx]

- 1 Pull out the tray completely.



- 2 Locate the lever, and then pull it down to release the jam.

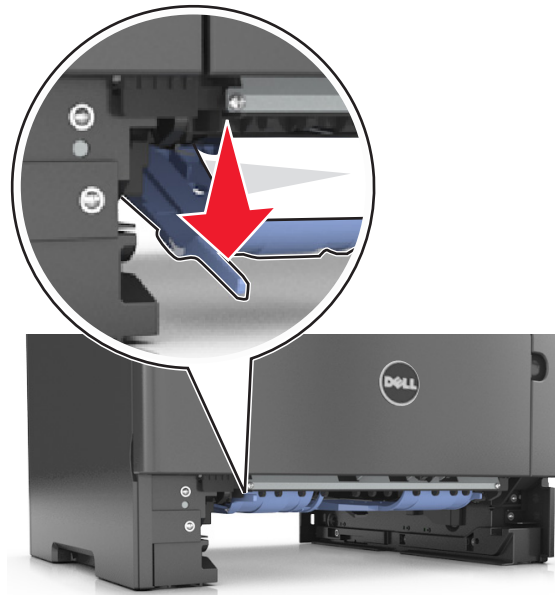

- 3 Firmly grasp the jammed paper on each side, and then gently pull it out.

Note: Make sure all paper fragments are removed.



4 Insert the tray.

5 From the printer control panel, touch **Done** to clear the message and continue printing.

[x]-page jam, clear manual feeder. [25y.xx]

1 From the multipurpose feeder, firmly grasp the jammed paper on each side, and then gently pull it out.

Note: Make sure all paper fragments are removed.



2 Flex the sheets back and forth to loosen them, and then fan them. Do not fold or crease the paper. Straighten the edges on a level surface.

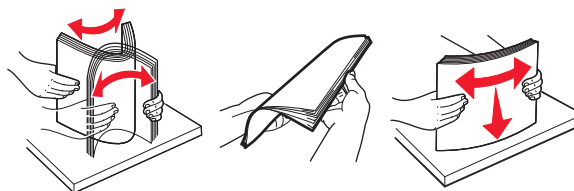

- 3 Reload paper into the multipurpose feeder.



Note: Make sure the paper guide lightly rests against the edge of the paper.

- 4 From the printer control panel, touch **Done** to clear the message and continue printing.

[x]-page jam, open tray [x]. [24y.xx]

- 1 Pull out the tray completely.

Note: The message on the printer display indicates the tray where the jammed paper is located.



- 2 Firmly grasp the jammed paper on each side, and then gently pull it out.

Note: Make sure all paper fragments are removed.



3 Insert the tray.

4 From the printer control panel, touch **Done** to clear the message and continue printing.

[x]-page jam, remove all pages from the output bin. Leave paper in bin. [45y.xx]

Paper jam in the finisher bin

1 Empty the standard bin.



2 Move the paper guides to the sides.



3 Remove all jammed pages from inside the access areas.

Note: Make sure all paper fragments are removed.



4 If necessary, touch **Done** from the printer control panel to clear the message and continue printing.

Paper jam in the finisher rear door

1 Open the finisher rear door.

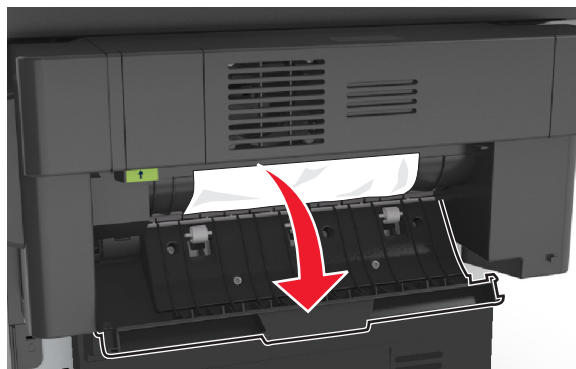

2 Firmly grasp the jammed paper on each side, and then gently pull it out.

Note: Make sure all paper fragments are removed.

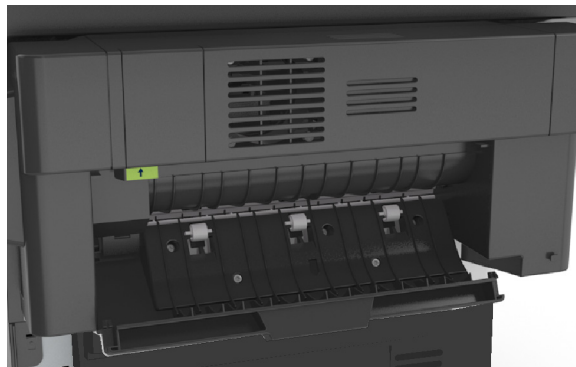

- 3 Open the finisher narrow door, and then remove any paper fragments inside the narrow door.

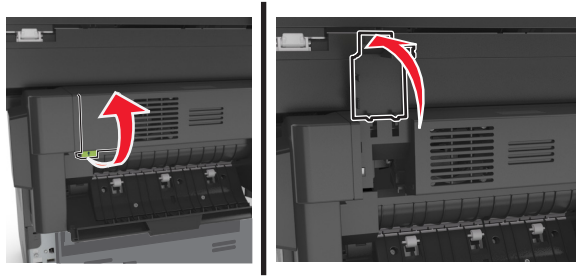

- 4 Close the narrow door.

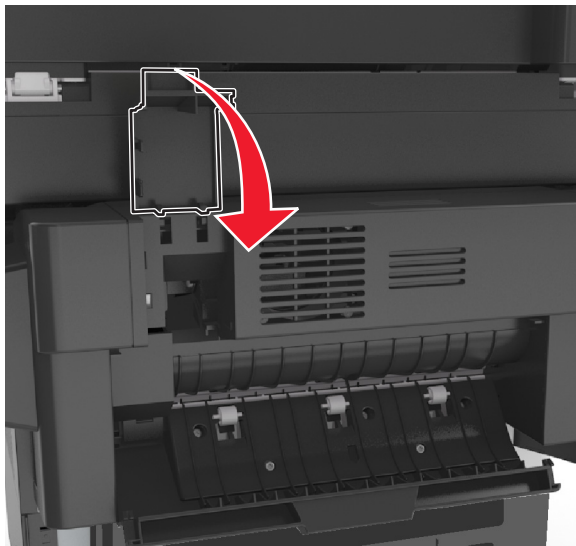

- 5 Close the finisher rear door.



- 6 If necessary, touch **Done** from the printer control panel to clear the message and continue printing.

Staple jam in the finisher

- 1 Open the staple access door.

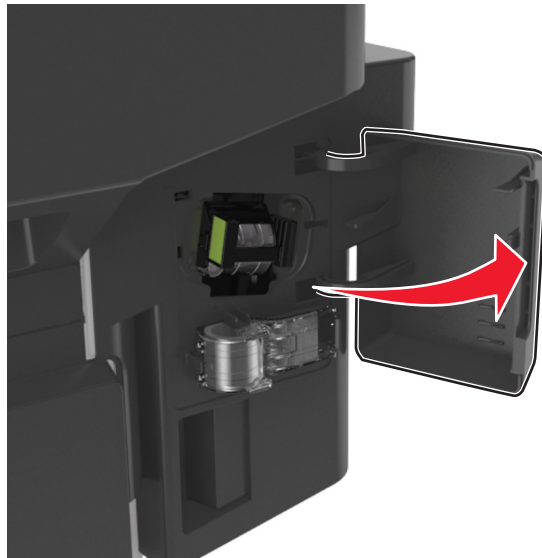

- 2 Pull out the staple cartridge from the finisher.

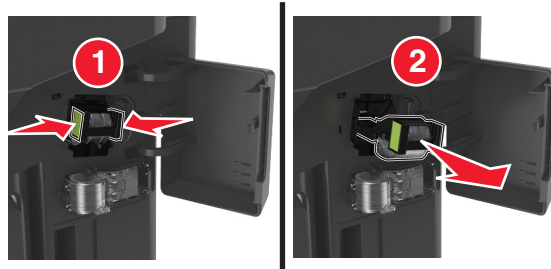

- 3 Lift the staple guard, and then remove any jammed or loose staples.

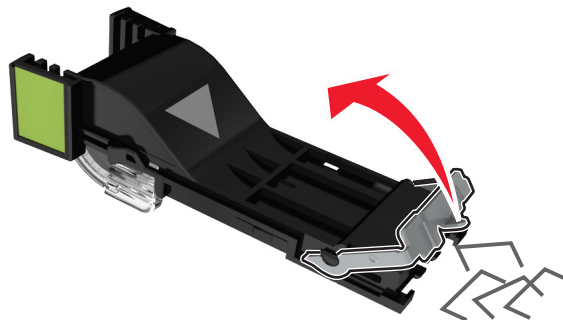

- 4 Press down the staple guard until it *clicks* into place.

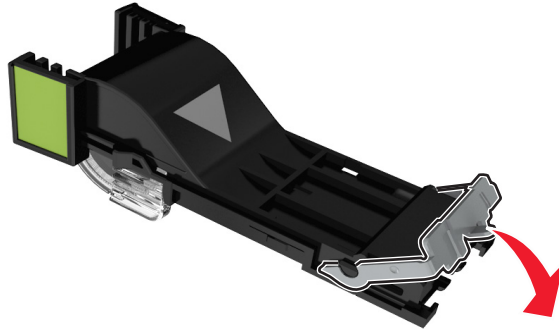

- 5 Insert staple cartridge back into the finisher until it *clicks* into place.

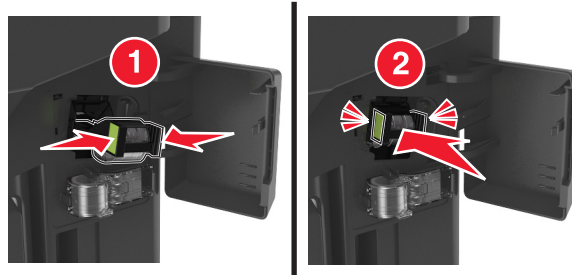

- 6 Close the staple access door.

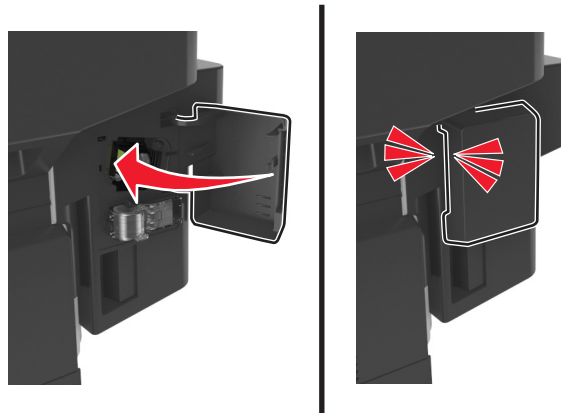

- 7 If necessary, touch **Done** from the printer control panel to clear the message and continue printing.

Troubleshooting

Understanding the printer messages

Cartridge low [88.xy]

You may need to order a replacement toner cartridge. If necessary, touch **Continue** on the printer control panel to clear the message and continue printing.

Cartridge nearly low [88.xy]

If necessary, touch **Continue** on the printer control panel to clear the message and continue printing.

Cartridge very low, [x] estimated pages remain [88.xy]

You may need to replace the toner cartridge very soon. For more information, see the “Replacing supplies” section of the *User’s Guide*.

If necessary, touch **Continue** on the printer control panel to clear the message and continue printing.

Change [paper source] to [custom type name] load [orientation]

Try one or more of the following:

- Load the correct size and type of paper in the tray or feeder, specify the paper size and type in the Paper menu on the printer control panel, and then touch **Finished changing paper**.
- Touch **Reset active bin** to reset the active bin for a linked set of bins.
- Cancel the print job.

Change [paper source] to [custom string] load [orientation]

Try one or more of the following:

- Load the correct size and type of paper in the tray or feeder, specify the paper size and type in the Paper menu on the printer control panel, and then touch **Finished changing paper**.
- Touch **Reset active bin** to reset the active bin for a linked set of bins.
- Cancel the print job.

Change [paper source] to [paper size] load [orientation]

Try one or more of the following:

- Load the correct size and type of paper in the tray or feeder, specify the paper size and type in the Paper menu on the printer control panel, and then touch **Finished changing paper**.
- Touch **Reset active bin** to reset the active bin for a linked set of bins.
- Cancel the print job.

Change [paper source] to [paper type] [paper size] load [orientation]

Try one or more of the following:

- Load the correct size and type of paper in the tray or feeder, specify the paper size and type in the Paper menu on the printer control panel, and then touch **Finished changing paper**.
- Touch **Reset active bin** to reset the active bin for a linked set of bins.
- Cancel the print job.

Check tray [x] connection

Try one or more of the following:

- Turn off the printer, and then turn it back on.

If the error occurs a second time, then:

- 1 Turn off the printer.
- 2 Unplug the power cord from the electrical outlet.
- 3 Remove the indicated tray.
- 4 Reattach the tray.
- 5 Connect the power cord to a properly grounded electrical outlet.
- 6 Turn the printer back on.

If the error occurs again, then:

- 1 Turn off the printer.
 - 2 Unplug the power cord from the electrical outlet.
 - 3 Remove the tray.
 - 4 Contact technical support.
- From the printer control panel, touch **Continue** to clear the message and resume the job.

Close front door

Close the front door of the printer.

Close rear door

Close the rear door of the printer.

Close finisher rear door

Close the rear door of the finisher.

Close flatbed cover and load originals if restarting job [2yy.xx]

Try one or more of the following:

- Touch **Scan from automatic feeder** to continue scanning from the ADF immediately after the last successful scan job.
- Touch **Scan from flatbed** to continue scanning from the scanner glass immediately after the last successful scan job.
- Touch **Finish job without further scanning** to end the last successful scan job.

Note: This does not cancel the scan job. All successfully scanned pages will be processed further for copying, faxing, or e-mailing.

- Touch **Cancel job** to clear the message and cancel the scan job.

Complex page, some data may not have printed [39]

Try one or more of the following:

- From the printer control panel, touch **Continue** to ignore the message and continue printing.
- Cancel current print job.
- Install additional printer memory.

Configuration change, some held jobs were not restored [57]

Held jobs are invalidated because of the following possible changes in the printer:

- The printer firmware has been updated.
- The tray for the print job has been removed.
- The print job is sent from a flash drive that is no longer attached to the USB port.
- The printer hard disk contains print jobs that were stored when the hard disk was installed in a different printer model.

From the printer control panel, touch **Continue** to clear the message.

Defective flash detected [51]

Try one or more of the following:

- Replace the defective flash memory card.
- From the printer control panel, touch **Continue** to ignore the message and continue printing.
- Cancel the current print job.

Disk full [62]

Try one or more of the following:

- From the printer control panel, touch **Continue** to clear the message and continue processing.
- Delete fonts, macros, and other data stored in the printer hard disk.
- Install a printer hard disk with larger capacity.

Disk must be formatted for use in this device

From the printer control panel, touch **Format disk** to format the printer hard disk and clear the message.

Note: Formatting deletes all the files stored in the printer hard disk.

Disk near full. Securely clearing disk space.

Try one or more of the following:

- Touch **Continue** to clear the message and continue printing.
- Delete fonts, macros, and other data stored on the printer hard disk.
- Install a hard disk with higher capacity.

Error reading USB drive. Remove USB.

An unsupported USB device is inserted. Remove the USB device, and then insert a supported one.

Error reading USB hub. Remove hub.

An unsupported USB hub has been inserted. Remove the USB hub, and then install a supported one.

Fax memory full

From the printer control panel, touch **Continue** to clear the message.

Fax partition inoperative. Contact system administrator.

Try one or more of the following:

- From the printer control panel, touch **Continue** to clear the message.
- Turn off the printer, and then turn it back on. If the message appears again, then contact your system support person.

Fax server 'To Format' not set up. Contact system administrator.

Try one or more of the following:

- From the printer control panel, touch **Continue** to clear the message.
- Complete the Fax Server setup. If the message appears again, then contact your system support person.

Fax Station Name not set up. Contact system administrator.

Try either of the following:

- From the printer control panel, touch **Continue** to clear the message.
- Complete the Analog Fax setup. If the message appears again after completing the setup, then contact your system support person.

Fax Station Number not set up. Contact system administrator.

Try one or more of the following:

- From the printer control panel, touch **Continue** to clear the message.
- Complete the Analog Fax setup. If the message appears again after completing the setup, then contact your system support person.

Imaging unit low [84.xy]

You may need to order a replacement imaging unit. If necessary, select **Continue** on the printer control panel to clear the message and continue printing.

Imaging unit nearly low [84.xy]

If necessary, touch **Continue** on the printer control panel to clear the message and continue printing.

Imaging unit very low, [x] estimated pages remain [84.xy]

You may need to replace the imaging unit very soon. For more information, see the “Replacing supplies” section of the *User’s Guide*.

If necessary, touch **Continue** on the printer control panel to clear the message and continue printing.

Incompatible tray [x] [59]

Try one or more of the following:

- Remove the indicated tray.
- From the printer control panel, touch **Continue** to clear the message and continue printing without using the indicated tray.

Incorrect paper size, open [paper source] [34]

Try one or more of the following:

- Load the correct size and type of paper in the tray, and then specify the paper size and type in the Paper menu on the printer control panel.
- Make sure the correct paper size and type are specified in Print Properties or the Print dialog settings.
- Check if the paper size is correctly set. For example, if MP Feeder Size is set to Universal, then make sure the paper is large enough for the data being printed.
- Check the length and width guides and make sure the paper is loaded properly in the tray.
- From the printer control panel, touch **Continue** to clear the message and print using a different tray.
- Cancel the print job.

Insufficient memory to collate job [37]

Try one or more of the following:

- From the printer control panel, touch **Continue** to print the part of the job already stored and begin collating the rest of the print job.
- Cancel the current print job.

Insufficient memory for Flash Memory Defragment operation [37]

Try one or more of the following:

- From the printer control panel, touch **Continue** to stop the defragmentation and continue printing.
- Delete fonts, macros, and other data in the printer memory.
- Install additional printer memory.

Insufficient memory, some Held Jobs were deleted [37]

From the printer control panel, touch **Continue** to clear the message.

Insufficient memory, some held jobs will not be restored [37]

Try one or more of the following:

- From the printer control panel, touch **Continue** to clear the message.
- Delete other held jobs to free up additional printer memory.

Insufficient memory to support Resource Save feature [35]

Install additional printer memory or touch **Continue** to disable Resource Save, clear the message, and continue printing.

Load [paper source] with [custom type name] [paper orientation]

Try one or more of the following:

- Load the tray or feeder with the correct size and type of paper.
- To use the tray with the correct paper size or type, touch **Finished loading paper** on the printer control panel.

Note: If the printer detects a tray that has the correct paper size and type, then it feeds from that tray. If the printer cannot detect a tray that has the correct paper size and type, then it prints from the default paper source.

- Cancel the current job.

Load [paper source] with [custom string] [paper orientation]

Try one or more of the following:

- Load the indicated tray or feeder with the correct size and type of paper.
- To use the tray with the correct paper size or type, touch **Finished loading paper** on the printer control panel.

Note: If the printer finds a tray that has the correct paper size and type, then it feeds from that tray. If the printer cannot find a tray with the correct paper type and size, then it prints from the default paper source.

- Cancel the current job.

Load [paper source] with [paper size] [paper orientation]

Try one or more of the following:

- Load the specified tray or feeder with the correct size of paper.
- To use the tray or feeder with the correct size of paper, touch **Finished loading paper** on the printer control panel.

Note: If the printer finds a tray or feeder that has the correct size of paper, then it feeds from that tray or feeder. If the printer cannot find a tray or feeder with the correct size of paper, then it prints from the default paper source.

- Cancel the current job.

Load [paper source] with [paper type] [paper size] [paper orientation]

Try one or more of the following:

- Load the specified tray or feeder with the correct size and type of paper.
- To use the tray or feeder with the correct size and type of paper, touch **Finished loading paper** on the printer control panel.

Note: If the printer finds a tray or feeder that has the correct size and type of paper, then it feeds from that tray or feeder. If the printer cannot find a tray or feeder with the correct size and type of paper, then it prints from the default paper source.

- Cancel the current job.

Load Manual Feeder with [custom type name] [paper orientation]

Try one or more of the following:

- Load the feeder with the correct size and type of paper.
- From the printer control panel, touch **Prompt each page, paper loaded** or **Do not prompt, paper loaded** to clear the message and continue printing.
- From the printer control panel, touch **Automatically select paper** to use the paper loaded in the tray.
- Cancel the print job.

Load Manual Feeder with [custom string] [paper orientation]

Try one or more of the following:

- Load the feeder with the correct size and type of paper.
- From the printer control panel, touch **Prompt each page, paper loaded** or **Do not prompt, paper loaded** to clear the message and continue printing.
- From the printer control panel, touch **Automatically select paper** to use the paper loaded in the tray.
- Cancel the print job.

Load Manual Feeder with [paper size] [paper orientation]

Try one or more of the following:

- Load the feeder with the correct size of paper.
- From the printer control panel, touch **Prompt each page, paper loaded** or **Do not prompt, paper loaded** to clear the message and continue printing.
- From the printer control panel, touch **Automatically select paper** to use the paper loaded in the tray.
- Cancel the print job.

Load Manual Feeder with [paper type] [paper size] [paper orientation]

Try one or more of the following:

- Load the feeder with the correct size and type of paper.
- From the printer control panel, touch **Prompt each page, paper loaded** or **Do not prompt, paper loaded** to clear the message and continue printing.
- From the printer control panel, touch **Automatically select paper** to use the paper loaded in the tray.
- Cancel the print job.

Maintenance kit low [80.xy]

You may need to order a maintenance kit. For more information, contact technical support or your Dell printer dealer.

If necessary, touch **Continue** to clear the message and continue printing.

Maintenance kit nearly low [80.xy]

For more information, contact technical support or your Dell printer dealer.

If necessary, touch **Continue** to clear the message and continue printing.

Maintenance kit very low, [x] estimated pages remain [80.xy]

You may need to replace the maintenance kit very soon. For more information, contact technical support or your Dell printer dealer.

If necessary, touch **Continue** to clear the message and continue printing.

Memory full [38]

Try one or more of the following:

- From the printer control panel, touch **Cancel job** to clear the message.
- Install additional printer memory.

Memory full, cannot print faxes

From the printer control panel, touch **Continue** to clear the message without printing. Held faxes attempt to print after the printer is restarted.

Memory full, cannot send faxes

- 1 From the printer control panel, touch **Continue** to clear the message and cancel the fax job.
- 2 Try one or more of the following:
 - Reduce the fax resolution, and then resend the fax job.
 - Reduce the number of pages in the fax, and then resend the fax job.

Network [x] software error [54]

Try one or more of the following:

- From the printer control panel, touch **Continue** to continue printing.
- Turn off the printer, wait for about 10 seconds, and then turn the printer back on.
- Update the network firmware in the printer or print server. For more information, contact technical support or your Dell printer dealer.

No analog phone line connected to modem, fax is disabled.

Connect the printer to an analog phone line.

Non-Dell [supply type], see User's Guide [33.xy]

Note: The supply type can either be a toner cartridge or imaging unit.

The printer has detected a non-Dell supply or part installed in the printer.

Your Dell printer is designed to function best with genuine Dell supplies and parts. Use of third-party supplies or parts may affect the performance, reliability, or life of the printer and its imaging components.

All life indicators are designed to function with Dell supplies and parts, and may deliver unpredictable results if third-party supplies or parts are used. Imaging component usage beyond the intended life may damage your Dell printer or associated components.

Warning—Potential Damage: Use of third-party supplies or parts can affect warranty coverage. Damage caused by the use of third-party supplies or parts are not covered by the warranty.

To accept any and all of these risks and to proceed with the use of non-genuine supplies or parts in your printer, press and hold  and # on the printer control panel simultaneously for 15 seconds to clear the message and continue printing.

If you do not wish to accept these risks, then remove the third-party supply or part from your printer, and then install a genuine Dell supply or part.

Note: For the list of supported supplies, see the “Ordering supplies” section of the *User's Guide* or visit www.dell.com/support/printers.

Not enough free space in flash memory for resources [52]

Try one or more of the following:

- From the printer control panel, touch **Continue** to clear the message and continue printing.
- Delete fonts, macros, and other data stored in the flash memory.
- Install a flash memory card with larger capacity.

Note: Downloaded fonts and macros not previously stored in the flash memory are deleted.

Paper changes needed

Try one or more of the following:

- From the printer control panel, touch **Prompt for each page** to continue printing.
- Touch **Use current supplies** to continue printing using the paper loaded in the tray.
- Cancel the current print job.

Parallel port [x] disabled [56]

Try one or more of the following:

- From the printer control panel, touch **Continue** to clear the message.
- Enable the parallel port. From the printer control panel, navigate to:
Network/Ports > Parallel [x] > Parallel Buffer > Auto

Note: The printer discards any data received through the parallel port.

Printer had to restart. Last job may be incomplete.

From the printer control panel, touch **Continue** to clear the message and continue printing.

For more information, visit www.dell.com/support/printers or contact technical support.

Remove defective disk [61]

Remove and replace the defective printer hard disk.

Remove paper from standard output bin

Remove the paper stack from the standard bin.

Replace defective imaging unit [31.xy]

Replace the defective imaging unit to clear the message. For more information, see the instruction sheet that came with the supply.

Note: If you do not have a replacement imaging unit, then see the “Ordering supplies” section of the *User’s Guide* or visit our Web site.

Reinstall missing or unresponsive cartridge [31.xy]

Try one or more of the following:

- Check if the toner cartridge is missing. If missing, install the toner cartridge.
For information on installing the cartridge, see the “Replacing supplies” section of the *User’s Guide*.
- If the toner cartridge is installed, then remove the unresponsive toner cartridge, and then reinstall it.

Note: If the message appears after reinstalling the supply, then the cartridge is defective. Replace the toner cartridge.

Replace cartridge, printer region mismatch [42.xy]

Install a suitable toner cartridge.

Replace cartridge, 0 estimated pages remain [88.xy]

Replace the toner cartridge to clear the message and continue printing. For more information, see the instruction sheet that came with the supply or see the “Replacing supplies” section of the *User’s Guide*.

Note: If you do not have a replacement cartridge, then visit our Web site or contact the place where you purchased the printer.

Replace imaging unit, 0 estimated pages remain [84.xy]

Replace the imaging unit to clear the message and continue printing. For more information, see the instruction sheet that came with the supply or see the “Replacing supplies” section of the *User’s Guide*.

Note: If you do not have a replacement imaging unit, then visit our Web site or contact the place where you purchased the printer.

Replace maintenance kit, 0 estimated pages remain [80.xy]

The printer is scheduled for maintenance. Contact technical support or your Dell printer dealer, and then report the message.

Replace all originals if restarting job.

Try one or more of the following:

- Touch **Cancel job** to clear the message and cancel the scan job.
- Touch **Scan from automatic feeder** to continue scanning from the ADF immediately after the last successful scan job.

- Touch **Scan from flatbed** to continue scanning from the scanner immediately after the last successful scan job.
- Touch **Finish job without further scanning** to end the last successful scan job.
- Touch **Restart job** to restart the scan job with the same settings from the previous scan job.

Reinstall missing or unresponsive imaging unit [31.xy]

Try one or more of the following:

- Check if the imaging unit is missing. If missing, install the imaging unit.
For information on installing the imaging unit, see the “Replacing supplies” section of the *User’s Guide*.
- If the imaging unit is installed, then remove the unresponsive imaging unit, and then reinstall it.

Note: If the message appears after reinstalling the supply, then the imaging unit is defective. Replace the imaging unit.

Replace unsupported cartridge [32.xy]

Remove the toner cartridge, and then install a supported one to clear the message and continue printing. For more information, see the instruction sheet that came with the supply or see the “Replacing supplies” section of the *User’s Guide*.

Note: If you do not have a replacement cartridge, then visit our Web site or contact the place where you purchased the printer.

Replace unsupported imaging unit [32.xy]

Remove the imaging unit, and then install a supported one to clear the message and continue printing. For more information, see the instruction sheet that came with the supply or see the “Replacing supplies” section of the *User’s Guide*.

Note: If you do not have a replacement imaging unit, then visit our Web site or contact the place where you purchased the printer.

Restore held jobs?

Try one or more of the following:

- From the printer control panel, touch **Restore** to restore all held jobs stored in the printer hard disk.
- From the printer control panel, touch **Do not restore** if you do not want to restore any of the print jobs.

Scanner automatic feeder cover open

Close the ADF cover.

Scanner disabled by admin [840.01]

Print without the scanner, or contact your system support person.

Scanner disabled. Contact system administrator if problem persists. [840.02]

Try one or more of the following:

- Touch **Continue with scanner disabled** to return to the home screen, and then contact your system support person.
- Touch **Reboot and automatically enable scanner** to cancel the job.

Note: This attempts to enable the scanner.

Scanner jam, remove all originals from the scanner [2yy.xx]

Remove the jammed paper from the scanner.

Scanner jam, remove jammed originals from the scanner [2yy.xx]

Remove the jammed paper from the scanner.

Serial port [x] disabled [56]

Try one or more of the following:

- From the printer control panel, touch **Continue** to clear the message.
The printer discards any data received through the specified serial port.
- Make sure Serial Buffer is not set to Disabled.
- From the printer control panel, set Serial Buffer to Auto in the Serial [x] menu.

SMTP server not set up. Contact system administrator.

From the printer control panel, touch **Continue** to clear the message.

Note: If the message appears again, then contact your system support person.

Some held jobs were not restored

From the printer control panel, touch **Continue** to delete the indicated job.

Note: Held jobs that are not restored remain in the printer hard disk and are inaccessible.

Standard network software error [54]

Try one or more of the following:

- From the printer control panel, touch **Continue** to continue printing.
- Turn off the printer, and then turn it back on.
- Update the network firmware in the printer or print server. For more information, visit the Dell support Web site at www.dell.com/support/printers or contact your system support person.

Standard USB port disabled [56]

Try one or more of the following:

- From the printer control panel, touch **Continue** to clear the message.
- Enable the USB port. From the printer control panel, navigate to:
Network/Ports > USB Buffer > Auto

Note: The printer discards any data received through the USB port.

Supply needed to complete job

Do either of the following:

- Install the missing supply to complete the job.
- Cancel the current job.

Too many flash options installed [58]

- 1 Turn off the printer.
- 2 Unplug the power cord from the electrical outlet.
- 3 Remove the extra flash memory.
- 4 Connect the power cord to a properly grounded electrical outlet.
- 5 Turn the printer back on.

Too many trays attached [58]

- 1 Turn off the printer.
- 2 Unplug the power cord from the electrical outlet.
- 3 Remove the extra trays.
- 4 Connect the power cord to a properly grounded electrical outlet.
- 5 Turn the printer back on.

Unformatted flash detected [53]

Try one or more of the following:

- From the printer control panel, touch **Continue** to stop the defragmentation and continue printing.
- Format the flash memory.

Note: If the error message remains, then the flash memory may be defective and needs to be replaced.

Unsupported disk

Remove the unsupported printer hard disk, and then insert a supported one.

Unsupported option in slot [x] [55]

- 1 Turn off the printer.
- 2 Unplug the power cord from the electrical outlet.
- 3 Remove the unsupported option card from the printer controller board, and then replace it with a supported card.
- 4 Connect the power cord to a properly grounded electrical outlet.
- 5 Turn the printer back on.

USB port [x] disabled [56]

From the printer control panel, touch **Continue** to clear the message.

Notes:

- The printer discards any data received through the USB port.
- Make sure the USB Buffer menu is not set to Disabled.

Weblink server not set up. Contact system administrator.

From the printer control panel, touch **Continue** to clear the message.

Note: If the message appears again, then contact your system support person.

Solving printer problems

- “Basic printer problems” on page 254
- “Option problems” on page 257
- “Paper feed problems” on page 260

Basic printer problems

The printer is not responding

Action	Yes	No
<p>Step 1 Make sure the printer is turned on.</p> <p>Is the printer turned on?</p>	Go to step 2.	Turn on the printer.
<p>Step 2 Check if the printer is in Sleep mode or Hibernate mode.</p> <p>Is the printer in Sleep mode or Hibernate mode?</p>	Press the Sleep button to wake the printer from Sleep mode or Hibernate mode.	Go to step 3.

Action	Yes	No
<p>Step 3 Check if one end of the power cord is plugged into the printer and the other to a properly grounded electrical outlet.</p> <p>Is the power cord plugged into the printer and a properly grounded electrical outlet?</p>	Go to step 4.	Plug one end of the power cord into the printer and the other to a properly grounded electrical outlet.
<p>Step 4 Check other electrical equipment plugged into the electrical outlet.</p> <p>Does other electrical equipment work?</p>	Unplug the other electrical equipment, and then turn on the printer. If the printer does not work, then reconnect the other electrical equipment.	Go to step 5.
<p>Step 5 Check if the cables connecting the printer and the computer are inserted in the correct ports.</p> <p>Are the cables inserted in the correct ports?</p>	Go to step 6.	Make sure to match the following: <ul style="list-style-type: none"> • The USB symbol on the cable with the USB symbol on the printer • The appropriate Ethernet cable with the Ethernet port
<p>Step 6 Make sure the electrical outlet is not turned off by a switch or breaker.</p> <p>Is the electrical outlet turned off by a switch or breaker?</p>	Turn on the switch or reset the breaker.	Go to step 7.
<p>Step 7 Check if the printer is plugged into any surge protectors, uninterruptible power supplies, or extension cords.</p> <p>Is the printer plugged into any surge protectors, uninterruptible power supplies, or extension cords?</p>	Connect the printer power cord directly to a properly grounded electrical outlet.	Go to step 8.
<p>Step 8 Check if one end of the printer cable is plugged into a port on the printer and the other to the computer, print server, option, or other network device.</p> <p>Is the printer cable securely attached to the printer and the computer, print server, option, or other network device?</p>	Go to step 9.	Connect the printer cable securely to the printer and the computer, print server, option, or other network device.
<p>Step 9 Make sure to install all hardware options properly and remove any packing material.</p> <p>Are all hardware options properly installed and all packing material removed?</p>	Go to step 10.	Turn off the printer, remove all packing materials, then reinstall the hardware options, and then turn on the printer.

Action	Yes	No
<p>Step 10 Check if you have selected the correct port settings in the printer driver.</p> <p>Are the port settings correct?</p>	Go to step 11.	Use correct printer driver settings.
<p>Step 11 Check the installed printer driver.</p> <p>Is the correct printer driver installed?</p>	Go to step 12.	Install the correct printer driver.
<p>Step 12 Turn off the printer, then wait for about 10 seconds, and then turn the printer back on.</p> <p>Is the printer working?</p>	The problem is solved.	Contact technical support .

Printer display is blank

Action	Yes	No
<p>Step 1 Press the Sleep button on the printer control panel.</p> <p>Does Ready appear on the printer display?</p>	The problem is solved.	Go to step 2.
<p>Step 2 Turn off the printer, then wait for about 10 seconds, and then turn the printer back on.</p> <p>Do Please wait and Ready appear on the printer display?</p>	The problem is solved.	Turn off the printer, and then contact technical support .

Option problems

Cannot detect internal option

Action	Yes	No
<p>Step 1 Turn off the printer, then wait for about 10 seconds, and then turn on the printer.</p> <p>Does the internal option operate correctly?</p>	The problem is solved.	Go to step 2.
<p>Step 2 Check if the internal option is properly installed in the controller board.</p> <ul style="list-style-type: none"> a Turn off the printer using the power switch, and then unplug the power cord from the electrical outlet. b Make sure the internal option is installed in the appropriate connector in the controller board. c Connect the power cord to the printer, then to a properly grounded electrical outlet, and then turn on the printer. <p>Is the internal option properly installed in the controller board?</p>	Go to step 3.	Connect the internal option to the controller board.
<p>Step 3 Print a menu settings page, and then check to see if the internal option is listed in the Installed Features list.</p> <p>Is the internal option listed in the menu settings page?</p>	Go to step 4.	Reinstall the internal option.
<p>Step 4</p> <ul style="list-style-type: none"> a Check if the internal option is selected. It may be necessary to manually add the internal option in the printer driver to make it available for print jobs. For more information, see “Adding available options in the print driver” on page 44. b Resend the print job. <p>Does the internal option operate correctly?</p>	The problem is solved.	Contact technical support .

Tray problems

Action	Yes	No
<p>Step 1</p> <p>a Pull out the tray, and then do one or more of the following:</p> <ul style="list-style-type: none"> • Check for paper jams or misfeeds. • Check if the paper size indicators on the paper guides are aligned with the paper size indicators on the tray. • If you are printing on custom-size paper, then make sure that the paper guides rest against the edges of the paper. • Make sure the paper is below the maximum paper fill indicator. • Make sure paper lies flat in the tray. <p>b Check if the tray closes properly.</p> <p>Is the tray working?</p>	The problem is solved.	Go to step 2.
<p>Step 2</p> <p>a Turn off the printer, then wait about 10 seconds, and then turn the printer back on.</p> <p>b Resend the print job.</p> <p>Is the tray working?</p>	The problem is solved.	Go to step 3.
<p>Step 3</p> <p>Check if the tray is installed and recognized by the printer.</p> <p>Print a menu settings page, and then check if the tray is listed in the Installed Features list.</p> <p>Is the tray listed in the menu settings page?</p>	Go to step 4.	Reinstall the tray. For more information, see the setup documentation that came with the tray.
<p>Step 4</p> <p>Check if the tray is available in the printer driver.</p> <p>Note: If necessary, manually add the tray in the printer driver to make it available for print jobs. For more information, see “Adding available options in the print driver” on page 44.</p> <p>Is the tray available in the printer driver?</p>	The problem is solved.	Contact technical support .

Cannot detect memory card

Action	Yes	No
<p>Make sure the memory card is installed.</p> <p>a Install the memory card. For more information, see “Installing a memory card” on page 29.</p> <p>Note: Check if the memory card is securely connected to the printer controller board.</p> <p>b Print a menu settings page, and then check if the card is listed in the Installed Options list.</p> <p>Is the card listed in the Installed Options list?</p>	<p>The problem is solved.</p>	<p>Contact technical support.</p>

Internal Solutions Port does not operate correctly

Action	Yes	No
<p>Step 1</p> <p>Make sure the Internal Solutions Port (ISP) is installed.</p> <p>a Install the ISP. For more information, see “Installing an Internal Solutions Port” on page 32.</p> <p>b Print a menu settings page, and then check if the ISP is listed in the Installed Features list.</p> <p>Is the ISP listed in the Installed Features list?</p>	<p>Go to step 2.</p>	<p>Check if you have a supported ISP.</p> <p>Note: An ISP from another printer may not work on this printer.</p>
<p>Step 2</p> <p>Check the cable and the ISP connection.</p> <p>a Use the correct cable, and then make sure it is securely connected to the ISP.</p> <p>b Check if the ISP solution interface cable is securely connected into the receptacle of the controller board.</p> <p>Note: The ISP solution interface cable and the receptacle on the controller board are color-coded.</p> <p>Does the Internal Solutions Port operate correctly?</p>	<p>The problem is solved.</p>	<p>Contact technical support.</p>

USB/parallel interface card does not operate correctly

Action	Yes	No
<p>Step 1</p> <p>Make sure the USB or parallel interface card is installed.</p> <p>a Install the USB or parallel interface card. For more information, see “Installing an Internal Solutions Port” on page 32.</p> <p>b Print a menu settings page, and then check if the USB or parallel interface card is listed in the Installed Features list.</p> <p>Is the USB or parallel interface card listed in the Installed Features list?</p>	<p>Go to step 2.</p>	<p>Check if you have a supported USB or parallel interface card.</p> <p>Note: A USB or parallel interface card from another printer may not work on this printer.</p>

Action	Yes	No
<p>Step 2</p> <p>Check the cable and the USB or parallel interface card connection. Use the correct cable, and then make sure it is securely connected to the USB or parallel interface card.</p> <p>Does the USB or parallel interface card operate correctly?</p>	The problem is solved.	Contact technical support .

Paper feed problems

Paper frequently jams

Action	Yes	No
<p>Step 1</p> <p>a Pull out the tray, and then do one or more of the following:</p> <ul style="list-style-type: none"> • Make sure paper lies flat in the tray. • Check if the paper size indicators on the paper guides are aligned with the paper size indicators on the tray. • Check if the paper guides are aligned against the edges of the paper. • Make sure the paper is below the maximum paper fill indicator. • Check if you are printing on a recommended paper size and type. <p>b Insert the tray properly. If jam recovery is enabled, then the print jobs will reprint automatically.</p> <p>Do paper jams still occur frequently?</p>	Go to step 2.	The problem is solved.
<p>Step 2</p> <p>a Load paper from a fresh package. Note: Paper absorbs moisture due to high humidity. Store paper in its original wrapper until you use it.</p> <p>b Resend the print job.</p> <p>Do paper jams still occur frequently?</p>	Go to step 3.	The problem is solved.
<p>Step 3</p> <p>a Review the tips on avoiding jams. For more information, see “Avoiding jams” on page 224.</p> <p>b Follow the recommendations, and then resend the print job.</p> <p>Do paper jams still occur frequently?</p>	Contact technical support .	The problem is solved.

Paper jam message remains after jam is cleared

Action	Yes	No
<p>Check the entire paper path for jammed paper.</p> <ul style="list-style-type: none"> a Remove any jammed paper. b From the printer control panel, touch Continue to clear the message. <p>Does the paper jam message remain?</p>	<p>Contact technical support.</p>	<p>The problem is solved.</p>

Jammed pages are not reprinted

Action	Yes	No
<p>Turn on Jam Recovery.</p> <ul style="list-style-type: none"> a From the home screen, navigate to: <ul style="list-style-type: none">  > Settings > General Settings > Print Recovery b From the Jam Recovery menu, touch the arrows to scroll to On or Auto. c Touch Submit. <p>Do pages reprint after a jam?</p>	<p>The problem is solved.</p>	<p>Contact technical support.</p>

Solving print problems

Printing problems

Multiple-language PDF files do not print

Action	Yes	No
<p>Step 1</p> <ul style="list-style-type: none"> a Check if the print options for the PDF output are set to embed all fonts. For more information, see the documentation that came with Adobe Acrobat. b Generate a new PDF file, and then resend the print job. <p>Do the files print?</p>	<p>The problem is solved.</p>	<p>Go to step 2.</p>
<p>Step 2</p> <ul style="list-style-type: none"> a Open the document you want to print in Adobe Acrobat. b Click File > Print > Advanced > Print As Image > OK > OK. <p>Do the files print?</p>	<p>The problem is solved.</p>	<p>Contact technical support.</p>

Error message about reading the flash drive appears

Action	Yes	No
<p>Step 1 Check if the flash drive is inserted into the front USB port. Note: The flash drive will not work if it is inserted into the rear USB port.</p> <p>Is the flash drive inserted into the front USB port?</p>	Go to step 2.	Insert the flash drive into the front USB port.
<p>Step 2 Check if the indicator light on the printer control panel is blinking green. Note: A green blinking light indicates that the printer is busy.</p> <p>Is the indicator light blinking green?</p>	Wait until the printer is ready, then view the held jobs list, and then print the documents.	Go to step 3.
<p>Step 3 a Check for an error message on the display. b Clear the message.</p> <p>Does the error message still appear?</p>	Go to step 4.	The problem is solved.
<p>Step 4 Check if the flash drive is supported. For more information on tested and approved USB flash drives, see “Supported flash drives and file types” on page 77.</p> <p>Does the error message still appear?</p>	Go to step 5.	The problem is solved.
<p>Step 5 Check if the USB port is disabled by the system support person.</p> <p>Does the error message still appear?</p>	Contact technical support .	The problem is solved.

Print jobs do not print

Action	Yes	No
<p>Step 1 a From the document you are trying to print, open the Print dialog and check if you have selected the correct printer. Note: If the printer is not the default printer, then you must select the printer for each document that you want to print. b Resend the print job.</p> <p>Do the jobs print?</p>	The problem is solved.	Go to step 2.



Action	Yes	No
<p>Step 2</p> <p>a Check if the printer is plugged in and turned on, and if Ready appears on the printer display.</p> <p>b Resend the print job.</p> <p>Do the jobs print?</p>	The problem is solved.	Go to step 3.
<p>Step 3</p> <p>If an error message appears on the printer display, then clear the message.</p> <p>Note: The printer continues to print after clearing the message.</p> <p>Do the jobs print?</p>	The problem is solved.	Go to step 4.
<p>Step 4</p> <p>a Check if the ports (USB, serial, or Ethernet) are working and if the cables are securely connected to the computer and the printer.</p> <p>Note: For more information, see the setup documentation that came with the printer.</p> <p>b Resend the print job.</p> <p>Do the jobs print?</p>	The problem is solved.	Go to step 5.
<p>Step 5</p> <p>a Turn off the printer, wait for about 10 seconds, and then turn the printer back on.</p> <p>b Resend the print job.</p> <p>Do the jobs print?</p>	The problem is solved.	Go to step 6.
<p>Step 6</p> <p>a Remove, and then reinstall the printer software. For more information, see “Installing the printer” on page 44.</p> <p>Note: The printer software is available at www.dell.com/support/printers.</p> <p>b Resend the print job.</p> <p>Do the jobs print?</p>	The problem is solved.	Contact technical support .

Confidential and other held jobs do not print

Note: Confidential, Verify, Reserve, and Repeat print jobs may be deleted if the printer requires extra memory to process additional held jobs.

Action	Yes	No
<p>Step 1 Open the held jobs folder on the printer display, and then verify that your print job is listed.</p> <p>Is your print job listed in the held jobs folder?</p>	Go to step 2.	Select one of the Print and Hold options, and then resend the print job. For more information, see “Printing confidential and other held jobs” on page 78.
<p>Step 2 The print job may contain a formatting error or invalid data.</p> <ul style="list-style-type: none"> • Delete the print job, and then send it again. • For PDF files, generate a new PDF, and then print it again. <p>If you are printing from the Internet, then the printer may be reading multiple job titles as duplicates and deleting all jobs except the first one.</p> <p>For Windows users</p> <ol style="list-style-type: none"> Open the Print Properties folder. From the Print and Hold dialog, select the “Keep duplicate documents” check box. Enter a PIN number. <p>For Macintosh users Save each print job, name each job differently, and then send the individual jobs to the printer.</p> <p>Does the job print?</p>	The problem is solved.	Go to step 3.
<p>Step 3 Free up additional printer memory by deleting some of the held jobs.</p> <p>Does the job print?</p>	The problem is solved.	Add additional printer memory.

Print job takes longer than expected

Action	Yes	No
<p>Step 1 Change the environmental settings of the printer.</p> <p>a From the printer control panel, navigate to:</p> <p> > Settings > General Settings</p> <p>b Select Eco-Mode or Quiet Mode, and then select Off.</p> <p>Note: Disabling Eco-Mode or Quiet Mode may increase the consumption of energy or supplies, or both.</p> <p>Did the job print?</p>	The problem is solved.	Go to step 2.
<p>Step 2 Reduce the number and size of fonts, the number and complexity of images, and the number of pages in the print job, and then resend the job</p> <p>Did the job print?</p>	The problem is solved.	Go to step 3.
<p>Step 3</p> <p>a Remove held jobs stored in the printer memory.</p> <p>b Resend the print job.</p> <p>Did the job print?</p>	The problem is solved.	Go to step 4.
<p>Step 4</p> <p>a Disable the Page Protect feature. From the printer control panel, navigate to:</p> <p> >Settings > General Settings > Print Recovery > Page Protect > Off</p> <p>b Resend the print job.</p> <p>Did the job print?</p>	The problem is solved.	Go to step 5.
<p>Step 5</p> <p>a Check if the cable connections to the printer and print server are secure. For more information, see the setup documentation that came with the printer.</p> <p>b Resend the print job.</p> <p>Did the job print?</p>	The problem is solved.	Go to step 6.
<p>Step 6 Install additional printer memory, and then resend the print job.</p> <p>Did the job print?</p>	The problem is solved.	Contact technical support .

Job prints from the wrong tray or on the wrong paper

Action	Yes	No
<p>Step 1</p> <p>a Check if you are printing on paper that is supported by the tray.</p> <p>b Resend the print job.</p> <p>Did the job print from the correct tray or on the correct paper?</p>	The problem is solved.	Go to step 2.
<p>Step 2</p> <p>a From the Paper menu on the printer control panel, set the paper size and type to match the paper loaded in the tray.</p> <p>b Resend the print job.</p> <p>Did the job print from the correct tray or on the correct paper?</p>	The problem is solved.	Go to step 3.
<p>Step 3</p> <p>a Depending on your operating system, open Printing Preferences or the Print dialog, and then specify the paper type.</p> <p>b Resend the print job.</p> <p>Did the job print from the correct tray or on the correct paper?</p>	The problem is solved.	Go to step 4.
<p>Step 4</p> <p>a Check if the trays are not linked.</p> <p>b Resend the print job.</p> <p>Did the job print from the correct tray or on the correct paper?</p>	The problem is solved.	Contact technical support .

Incorrect characters print

Action	Yes	No
<p>Step 1</p> <p>Make sure the printer is not in Hex Trace mode.</p> <p>Note: If Ready Hex appears on the printer display, then turn off the printer, and then turn it back on to deactivate Hex Trace mode.</p> <p>Is the printer in Hex Trace mode?</p>	Deactivate Hex Trace mode.	Go to step 2.
<p>Step 2</p> <p>a From the printer control panel, select Standard Network or Network [x], and then set SmartSwitch to On.</p> <p>b Resend the print job.</p> <p>Do incorrect characters print?</p>	Contact technical support .	The problem is solved.

Tray linking does not work

Notes:

- The trays can detect paper length.
- The multipurpose feeder does not automatically detect the paper size. You must set the size from the Paper Size/Type menu.

Action	Yes	No
<p>Step 1</p> <p>a Open the trays, and then check if they contain paper of the same size and type.</p> <ul style="list-style-type: none"> • Check if the paper guides are in the correct positions for the size of the paper loaded in each tray. • Check if the paper size indicators on the paper guides are aligned with the paper size indicators on the tray. <p>b Resend the print job.</p> <p>Do the trays link correctly?</p>	The problem is solved.	Go to step 2.
<p>Step 2</p> <p>a From the printer control panel, set the paper size and type in the Paper menu to match the paper loaded in the trays to be linked.</p> <p>Note: The paper size and type must match for trays to be linked.</p> <p>b Resend the print job.</p> <p>Do the trays link correctly?</p>	The problem is solved.	Contact technical support .

Large jobs do not collate

Action	Yes	No
<p>Step 1</p> <p>a From the Finishing menu on the printer control panel, set Collate to (1,2,3) (1,2,3).</p> <p>b Resend the print job.</p> <p>Did the job print and collate correctly?</p>	The problem is solved.	Go to step 2.
<p>Step 2</p> <p>a From the printer software, set Collate to (1,2,3) (1,2,3).</p> <p>Note: Setting Collate to (1,1,1) (2,2,2) in the software overrides the setting in the Finishing menu.</p> <p>b Resend the print job.</p> <p>Did the job print and collate correctly?</p>	The problem is solved.	Go to step 3.

Action	Yes	No
<p>Step 3</p> <p>Reduce the complexity of the print job by eliminating the number and size of fonts, the number and complexity of images, and the number of pages in the job.</p> <p>Did the job print and collate correctly?</p>	<p>The problem is solved.</p>	<p>Contact technical support.</p>

Unexpected page breaks occur

Action	Yes	No
<p>Increase the printing timeout.</p> <p>a From the home screen, navigate to:</p> <p> > Settings > General Settings > Timeouts</p> <p>b Increase the Print Timeout setting, and then touch Submit.</p> <p>c Resend the print job.</p> <p>Did the file print correctly?</p>	<p>The problem is solved.</p>	<p>Check the original file for manual page breaks.</p>

Print quality problems

Characters have jagged or uneven edges

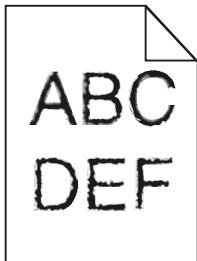

Action	Yes	No
<p>Step 1</p> <p>a Print a font sample list to check if the fonts you are using are supported by the printer.</p> <p>1 From the printer control panel, navigate to:</p> <p> > Reports > Print Fonts</p> <p>2 Touch PCL Fonts or PostScript Fonts.</p> <p>b Use a font that is supported by the printer or install the font that you want to use. For more information, contact your system support person.</p> <p>c Resend the print job.</p> <p>Do prints still contain characters that have jagged or uneven edges?</p>	<p>Go to step 2.</p>	<p>The problem is solved.</p>

Action	Yes	No
<p>Step 2</p> <p>a Use a font that is supported by the printer or install the font that you want to use on your computer. For more information, contact your system support person.</p> <p>b Resend the print job.</p> <p>Do prints still contain characters that have jagged or uneven edges?</p>	<p>Contact technical support.</p>	<p>The problem is solved.</p>

Printer is printing blank pages

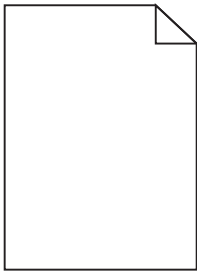

Action	Yes	No
<p>Step 1</p> <p>a Check if there is packing material left on the imaging unit.</p> <ol style="list-style-type: none"> 1 Remove the toner cartridge, and then the imaging unit. 2 Check if the packing material is properly removed from the imaging unit. <p>Warning—Potential Damage: Do not expose the imaging unit to direct light for more than 10 minutes. Extended exposure to light may cause print quality problems.</p> <ol style="list-style-type: none"> 3 Reinstall the imaging unit, and then the cartridge. <p>b Resend the print job.</p> <p>Is the printer still printing blank pages?</p>	<p>Go to step 2.</p>	<p>The problem is solved.</p>
<p>Step 2</p> <p>a Redistribute the toner in the imaging unit.</p> <ol style="list-style-type: none"> 1 Remove the toner cartridge, and then the imaging unit. 2 Firmly shake the imaging unit. <p>Warning—Potential Damage: Do not expose the imaging unit to direct light for more than 10 minutes. Extended exposure to light may cause print quality problems.</p> <ol style="list-style-type: none"> 3 Reinstall the imaging unit, and then the cartridge. <p>b Resend the print job.</p> <p>Is the printer still printing blank pages?</p>	<p>Go to step 3.</p>	<p>The problem is solved.</p>

Action	Yes	No
<p>Step 3 Replace the imaging unit, and then resend the print job.</p> <p>Is the printer still printing blank pages?</p>	<p>Contact technical support.</p>	<p>The problem is solved.</p>

Clipped pages or images

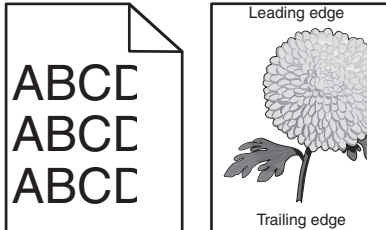

Action	Yes	No
<p>Step 1</p> <p>a Move the width and length guides in the tray to the correct positions for the paper loaded.</p> <p>b Resend the print job.</p> <p>Is the page or image clipped?</p>	<p>Go to step 2.</p>	<p>The problem is solved.</p>
<p>Step 2</p> <p>From the printer control panel, set the paper size and type in the Paper menu to match the paper loaded in the tray.</p> <p>Do the paper size and type match the paper loaded in the tray?</p>	<p>Go to step 3.</p>	<p>Do one or more of the following:</p> <ul style="list-style-type: none"> Specify the paper size from the tray settings to match the paper loaded in the tray. Change the paper loaded in the tray to match the paper size specified in the tray settings.
<p>Step 3</p> <p>a Depending on your operating system, specify the paper size from Printing Preferences or from the Print dialog.</p> <p>b Resend the print job.</p> <p>Is the page or image clipped?</p>	<p>Go to step 4.</p>	<p>The problem is solved.</p>

Action	Yes	No
<p>Step 4</p> <p>a Reinstall the imaging unit.</p> <ol style="list-style-type: none"> 1 Remove the toner cartridge. 2 Remove the imaging unit. <p>Warning—Potential Damage: Do not expose the imaging unit to direct light for more than 10 minutes. Extended exposure to light may cause print quality problems.</p> <ol style="list-style-type: none"> 3 Install the imaging unit, and then the cartridge. <p>b Resend the print job.</p> <p>Is the page or image clipped?</p>	<p>Contact technical support.</p>	<p>The problem is solved.</p>

Prints on color transparencies appear dark when projected

Note: This problem occurs when projecting transparencies with reflective overhead projectors. To obtain the highest projected color quality, transmissive overhead projectors are recommended.

Action	Yes	No
<p>Step 1</p> <p>From the printer control panel, make sure the paper type setting is set to Transparency.</p> <p>Is the paper type setting correct?</p>	<p>Go to step 2.</p>	<p>Set the paper type to Transparency.</p>
<p>Step 2</p> <p>Reduce the toner darkness, and then resend the print job.</p> <p>Does the print on the color transparency look lighter?</p>	<p>The problem is solved.</p>	<p>Go to step 3.</p>
<p>Step 3</p> <p>Make sure you are using a recommended type of color transparency, and then resend the print job.</p> <p>Does the print on the color transparency look lighter?</p>	<p>The problem is solved.</p>	<p>Contact technical support.</p>

Shadow images appear on prints

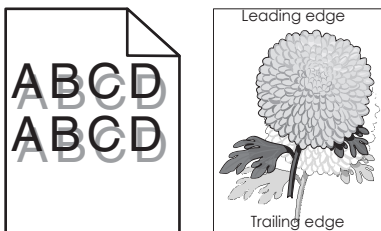

Action	Yes	No
<p>Step 1 Load paper with the correct paper type and weight in the tray.</p> <p>Is paper with the correct paper type and weight loaded in the tray?</p>	Go to step 2.	Load paper with the correct paper type and weight in the tray.
<p>Step 2 From the printer control panel, set the paper type and weight in the Paper menu to match the paper loaded in the tray.</p> <p>Is the tray set to the type and weight of the paper loaded?</p>	Go to step 3.	Change the paper loaded in the tray to match the paper type and weight specified in the tray settings.
<p>Step 3</p> <ul style="list-style-type: none"> a Depending on your operating system, specify the paper type and weight from Printing Preferences or from the Print dialog. b Resend the print job. <p>Do shadow images still appear on prints?</p>	Go to step 4.	The problem is solved.
<p>Step 4 Replace the imaging unit, and then resend the print job.</p> <p>Do shadow images still appear on prints?</p>	Contact technical support .	The problem is solved.

Gray background on prints

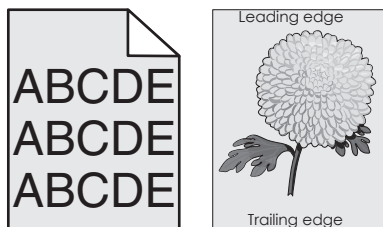

Action	Yes	No
<p>Step 1 Check if Allow Background Removal is set to Off.</p> <ul style="list-style-type: none"> a From the General Settings menu, set Allow Background Removal to On. b Resend the print job. <p>Did the background disappear from the prints?</p>	The problem is solved.	Go to step 2.

Action	Yes	No
<p>Step 2 Adjust the toner darkness to a lighter setting.</p> <p>a From the Quality Menu, select a lower value to reduce toner density.</p> <ul style="list-style-type: none"> • 4 is the factory default setting. • If Print Mode is set to Black Only, then a setting of 5 increases toner density and darkness for all print jobs. <p>b Resend the print job.</p> <p>Did the background disappear from the prints?</p>	The problem is solved.	Go to step 3.
<p>Step 3 Reinstall the toner cartridge.</p> <p>a Remove the cartridge.</p> <p>b Install the cartridge.</p> <p>c Resend the print job.</p> <p>Did the background disappear from the prints?</p>	The problem is solved.	Go to step 4.
<p>Step 4 Check if off-white background is selected.</p> <p>a Depending on your operating system, set off-white background from Print Properties or the Print dialog.</p> <p>b Resend the print job.</p> <p>Did the background disappear from the prints?</p>	The problem is solved.	Contact technical support .

Incorrect margins on prints

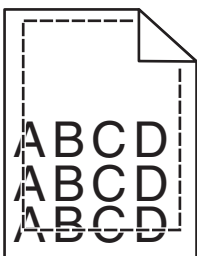

Action	Yes	No
<p>Step 1</p> <p>a Move the width and length guides in the tray to the correct positions for the paper size loaded.</p> <p>b Resend the print job.</p> <p>Are the margins correct?</p>	The problem is solved.	Go to step 2.

Action	Yes	No
<p>Step 2</p> <p>From the printer control panel, set the paper size in the Paper menu to match the paper loaded in the tray.</p> <p>Does the paper size match the paper loaded in the tray?</p>	Go to step 3.	<p>Do one or more of the following:</p> <ul style="list-style-type: none"> Specify the paper size from the tray settings to match the paper loaded in the tray. Change the paper loaded in the tray to match the paper size specified in the tray settings.
<p>Step 3</p> <p>a Depending on your operating system, specify the paper size from Printing Preferences or from the Print dialog.</p> <p>b Resend the print job.</p> <p>Are the margins correct?</p>	The problem is solved.	Contact technical support .

Paper curl

Action	Yes	No
<p>Step 1</p> <p>Move the width and length guides in the tray to the correct positions for the size of the paper loaded.</p> <p>Are the width and length guides positioned correctly?</p>	Go to step 2.	Adjust the width and length guides.
<p>Step 2</p> <p>From the printer control panel, set the paper type and weight in the Paper menu to match the paper loaded in the tray.</p> <p>Do the paper type and weight match the type and weight of the paper in the tray?</p>	Go to step 3.	Specify the paper type and weight from the tray settings to match the paper loaded in the tray.
<p>Step 3</p> <p>a Depending on your operating system, specify the paper type and weight from Printing Preferences or from the Print dialog.</p> <p>b Resend the print job.</p> <p>Is the paper still curled?</p>	Go to step 4.	The problem is solved.
<p>Step 4</p> <p>a Remove the paper from the tray, and then turn it over.</p> <p>b Resend the print job.</p> <p>Is the paper still curled?</p>	Go to step 5.	The problem is solved.

Action	Yes	No
<p>Step 5</p> <p>a Load paper from a fresh package.</p> <p>Note: Paper absorbs moisture due to high humidity. Store paper in its original wrapper until you use it.</p> <p>b Resend the print job.</p> <p>Is the paper still curled?</p>	<p>Contact technical support.</p>	<p>The problem is solved.</p>

Print irregularities

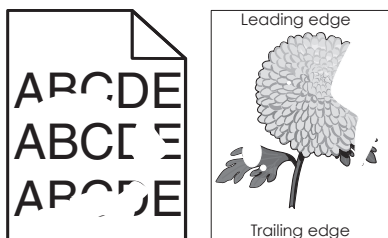

Action	Yes	No
<p>Step 1</p> <p>a Move the width and length guides in the tray to the correct positions for the size of the paper loaded in the tray.</p> <p>b Resend the print job.</p> <p>Do print irregularities still appear?</p>	<p>Go to step 2.</p>	<p>The problem is solved.</p>
<p>Step 2</p> <p>From the printer control panel, set the paper size and type in the Paper menu to match the paper loaded in the tray.</p> <p>Do the printer settings match the type and weight of the paper loaded in the tray?</p>	<p>Go to step 3.</p>	<p>Specify the paper size and type from the tray settings to match the paper loaded in the tray.</p>
<p>Step 3</p> <p>a Depending on your operating system, specify the paper type and weight from Printing Preferences or from the Print dialog.</p> <p>b Resend the print job.</p> <p>Do print irregularities still appear?</p>	<p>Go to step 4.</p>	<p>The problem is solved.</p>
<p>Step 4</p> <p>Check if the paper loaded in the tray has texture or rough finishes.</p> <p>Are you printing on textured or rough paper?</p>	<p>From the printer control panel, set the paper texture in the Paper menu to match the paper loaded in the tray.</p>	<p>Go to step 5.</p>

Action	Yes	No
<p>Step 5</p> <p>a Load paper from a fresh package.</p> <p>Note: Paper absorbs moisture due to high humidity. Store paper in its original wrapper until you use it.</p> <p>b Resend the print job.</p> <p>Do print irregularities still appear?</p>	Go to step 6.	The problem is solved.
<p>Step 6</p> <p>Replace the imaging unit, and then resend the print job.</p> <p>Do print irregularities still appear?</p>	Contact technical support or your Dell printer dealer.	The problem is solved.

Repeating defects appear on prints

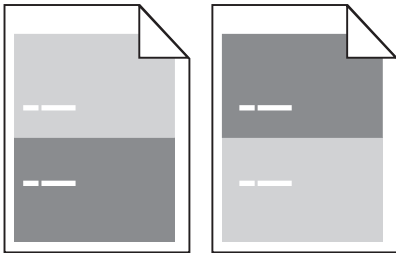

Action	Yes	No
<p>Step 1</p> <p>Measure the distance between the defects.</p> <p>Check for a distance between the defects that equals:</p> <ul style="list-style-type: none"> • 97 mm (3.82 in.) • 47 mm (1.85 in.) • 38 mm (1.5 in.) <p>Is the distance between defects equal to one of the listed measurements?</p>	Go to step 2.	<p>1 Check if the distance between the defects equal to 80 mm (3.15 in.)</p> <p>2 Take note of the distance, and then contact technical support or your Dell printer dealer.</p>
<p>Step 2</p> <p>Replace the imaging unit, and then resend the print job.</p> <p>Do the repeating defects still appear?</p>	Contact technical support or your Dell printer dealer.	The problem is solved.

Print is too dark

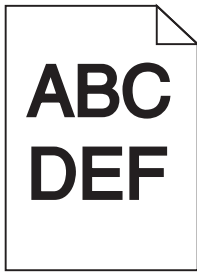

Action	Yes	No
<p>Step 1</p> <p>a From the Quality menu on the printer control panel, reduce the toner darkness.</p> <p>Note: 8 is the factory default setting.</p> <p>b Resend the print job.</p> <p>Is the print still too dark?</p>	Go to step 2.	The problem is solved.
<p>Step 2</p> <p>a From the printer control panel, set the paper type, texture and weight in the Paper menu to match the paper loaded in the tray.</p> <p>b Resend the print job.</p> <p>Is the tray set to the type, texture, and weight of the paper loaded?</p>	Go to step 3.	<p>Do one or more of the following:</p> <ul style="list-style-type: none"> Specify the paper type, texture, and weight from the tray settings to match the paper loaded in the tray. Change the paper loaded in the tray to match the paper type, texture and weight specified in the tray settings.
<p>Step 3</p> <p>a Depending on your operating system, specify the paper type, texture and weight from Printing Preferences or from the Print dialog.</p> <p>b Resend the print job.</p> <p>Is the print still too dark?</p>	Go to step 4.	The problem is solved.
<p>Step 4</p> <p>Check if the paper loaded in the tray has texture or rough finishes.</p> <p>Are you printing on textured or rough paper?</p>	From the printer control panel, change the texture settings in the Paper Texture menu to match the paper you are printing on.	Go to step 5.

Action	Yes	No
<p>Step 5</p> <p>a Load paper from a fresh package.</p> <p>Note: Paper absorbs moisture due to high humidity. Store paper in its original wrapper until you use it.</p> <p>b Resend the print job.</p> <p>Is the print still too dark?</p>	Go to step 6.	The problem is solved.
<p>Step 6</p> <p>Replace the imaging unit, and then resend the print job.</p> <p>Is the print still too dark?</p>	Contact technical support .	The problem is solved.

Print is too light

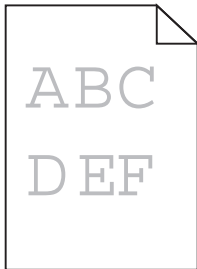

Action	Yes	No
<p>Step 1</p> <p>a From the Quality menu on the printer control panel, increase the toner darkness.</p> <p>Note: 8 is the factory default setting.</p> <p>b Resend the print job.</p> <p>Is the print still too light?</p>	Go to step 2.	The problem is solved.
<p>Step 2</p> <p>From the printer control panel, set the paper type, texture, and weight in the Paper menu to match the paper loaded in the tray.</p> <p>Is the tray set to the type, texture, and weight of the paper loaded?</p>	Go to step 3.	Change the paper type, texture, and weight to match the paper loaded in the tray.
<p>Step 3</p> <p>a Depending on your operating system, specify the paper type, texture, and weight from Printing Preferences or from the Print dialog.</p> <p>b Resend the print job.</p> <p>Is the print still too light?</p>	Go to step 4.	The problem is solved.

Action	Yes	No
<p>Step 4 Make sure that the paper has no texture or rough finishes.</p> <p>Are you printing on textured or rough paper?</p>	<p>From the printer control panel, change the texture settings in the Paper Texture menu to match the paper you are printing on.</p>	<p>Go to step 5.</p>
<p>Step 5 a Load paper from a fresh package. Note: Paper absorbs moisture due to high humidity. Store paper in its original wrapper until you use it. b Resend the print job.</p> <p>Is the print still too light?</p>	<p>Go to step 6.</p>	<p>The problem is solved.</p>
<p>Step 6 a Redistribute the toner in the imaging unit. 1 Remove the toner cartridge, and then the imaging unit. 2 Firmly shake the imaging unit. Warning—Potential Damage: Do not expose the imaging unit to direct light for more than 10 minutes. Extended exposure to light may cause print quality problems. 3 Install the imaging unit, and then the cartridge. b Resend the print job.</p> <p>Is the print still too light?</p>	<p>Go to step 7.</p>	<p>The problem is solved.</p>
<p>Step 7 Replace the imaging unit, and then resend the print job.</p> <p>Is the print still too light?</p>	<p>Contact technical support.</p>	<p>The problem is solved.</p>

Skewed print

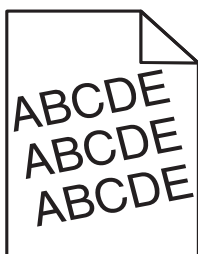

Action	Yes	No
<p>Step 1</p> <ul style="list-style-type: none"> a Move the width and length guides in the tray to the correct positions for the size of the paper loaded. b Resend the print job. <p>Is the print still skewed?</p>	Go to step 2.	The problem is solved.
<p>Step 2</p> <ul style="list-style-type: none"> a Check if you are printing on a paper that is supported by the tray. b Resend the print job. <p>Is the print still skewed?</p>	Contact technical support .	The problem is solved.

Printer is printing solid black pages



Action	Yes	No
<p>Step 1</p> <ul style="list-style-type: none"> a Reinstall the imaging unit. <ul style="list-style-type: none"> 1 Remove the toner cartridge, and then the imaging unit. <p>Warning—Potential Damage: Do not expose the imaging unit to direct light for more than 10 minutes. Extended exposure to light may cause print quality problems.</p> 2 Install the imaging unit, and then the cartridge. b Resend the print job. <p>Is the printer printing solid black pages?</p>	Go to step 2.	The problem is solved.
<p>Step 2</p> <p>Replace the imaging unit, and then resend the print job.</p> <p>Is the printer printing solid black pages?</p>	Contact technical support .	The problem is solved.

Transparency print quality is poor

Action	Yes	No
<p>Step 1 From the printer control panel, set the paper type in the Paper menu to match the paper loaded in the tray.</p> <p>Is the paper type for the tray set to Transparency?</p>	Go to step 2.	Set the paper type to Transparency.
<p>Step 2 <ul style="list-style-type: none"> a Check if you are using a recommended type of transparency. b Resend the print job. </p> <p>Is the print quality still poor?</p>	Contact technical support .	The problem is solved.

Streaked horizontal lines appear on prints

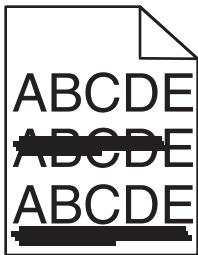

Action	Yes	No
<p>Step 1 <ul style="list-style-type: none"> a Depending on your operating system, specify the tray or feeder from Printing Preferences or the Print dialog. b Resend the print job. </p> <p>Do streaked horizontal lines appear on prints?</p>	Go to step 2.	The problem is solved.
<p>Step 2 From the printer control panel, set the paper type and weight in the Paper menu to match the paper loaded in the tray.</p> <p>Do the paper type and weight match the type and weight of the paper in the tray?</p>	Go to step 3.	Change the paper type and weight to match the paper loaded in the tray.
<p>Step 3 <ul style="list-style-type: none"> a Load paper from a fresh package. Note: Paper absorbs moisture due to high humidity. Store paper in its original wrapper until you use it. b Resend the print job. </p> <p>Do streaked horizontal lines appear on prints?</p>	Go to step 4.	The problem is solved.

Action	Yes	No
<p>Step 4</p> <p>a Reinstall the imaging unit.</p> <p>1 Remove the toner cartridge, and then the imaging unit.</p> <p>Warning—Potential Damage: Do not expose the imaging unit to direct light for more than 10 minutes. Extended exposure to light may cause print quality problems.</p> <p>2 Install the imaging unit, and then the cartridge.</p> <p>b Resend the print job.</p> <p>Do streaked horizontal lines appear on prints?</p>	Go to step 5.	The problem is solved.
<p>Step 5</p> <p>Replace the imaging unit, and then resend the print job.</p> <p>Do streaked horizontal lines appear on prints?</p>	Contact technical support .	The problem is solved.

Streaked vertical lines appear on prints

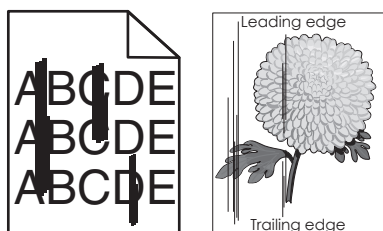

Action	Yes	No
<p>Step 1</p> <p>a Depending on your operating system, specify the paper type, texture, and weight from Printing Preferences or from the Print dialog.</p> <p>b Resend the print job.</p> <p>Do streaked vertical lines appear on prints?</p>	Go to step 2.	The problem is solved.
<p>Step 2</p> <p>From the printer control panel, set the paper texture, type, and weight in the Paper menu to match the paper loaded in the tray.</p> <p>Do the paper texture, type, and weight match the paper in the tray?</p>	Go to step 3.	<p>Do one or more of the following:</p> <ul style="list-style-type: none"> Specify the paper texture, type, and weight from the tray settings to match the paper loaded in the tray. Change the paper loaded in the tray to match the paper texture, type, and weight specified in the tray settings.

Action	Yes	No
<p>Step 3</p> <p>a Load paper from a fresh package.</p> <p>Note: Paper absorbs moisture due to high humidity. Store paper in its original wrapper until you use it.</p> <p>b Resend the print job.</p> <p>Do streaked vertical lines appear on prints?</p>	Go to step 4.	The problem is solved.
<p>Step 4</p> <p>a Reinstall the imaging unit.</p> <p>1 Remove the toner cartridge, and then the imaging unit.</p> <p>Warning—Potential Damage: Do not expose the imaging unit to direct light for more than 10 minutes. Extended exposure to light may cause print quality problems.</p> <p>2 Install the imaging unit, and then the cartridge.</p> <p>b Resend the print job.</p> <p>Do streaked vertical lines appear on prints?</p>	Go to step 5.	The problem is solved.
<p>Step 5</p> <p>Replace the imaging unit, and then resend the print job.</p> <p>Do streaked vertical lines appear on prints?</p>	Contact technical support or your Dell printer dealer.	The problem is solved.

Horizontal voids appear on prints

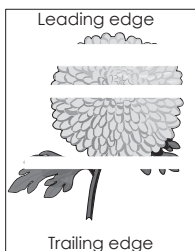

Action	Yes	No
<p>Step 1</p> <p>a Make sure your software program is using a correct fill pattern.</p> <p>b Resend the print job.</p> <p>Do horizontal voids appear on prints?</p>	Go to step 2.	The problem is solved.
<p>Step 2</p> <p>a Load the specified tray or feeder with a recommended type of paper.</p> <p>b Resend the print job.</p> <p>Do horizontal voids appear on prints?</p>	Go to step 3.	The problem is solved.

Action	Yes	No
<p>Step 3</p> <p>a Redistribute the toner in the imaging unit.</p> <ol style="list-style-type: none"> 1 Remove the toner cartridge, and then the imaging unit. 2 Firmly shake the imaging unit. <p>Warning—Potential Damage: Do not expose the imaging unit to direct light for more than 10 minutes. Extended exposure to light may cause print quality problems.</p> <ol style="list-style-type: none"> 3 Reinstall the imaging unit, and then the cartridge. <p>b Resend the print job.</p> <p>Do horizontal voids appear on prints?</p>	Go to step 4.	The problem is solved.
<p>Step 4</p> <p>Replace the imaging unit, and then resend the print job.</p> <p>Do horizontal voids appear on prints?</p>	Contact technical support .	The problem is solved.

Vertical voids appear on prints

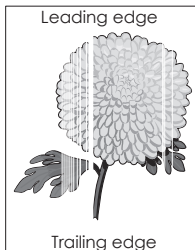

Action	Yes	No
<p>Step 1</p> <p>a Make sure your software program is using a correct fill pattern.</p> <p>b Resend the print job.</p> <p>Do vertical voids appear on prints?</p>	Go to step 2.	The problem is solved.
<p>Step 2</p> <p>a From the printer control panel, set the paper type and weight in the Paper menu to match the paper loaded in the tray.</p> <p>b Resend the print job.</p> <p>Do vertical voids appear on prints?</p>	Go to step 3.	The problem is solved.
<p>Step 3</p> <p>Check if you are using a recommended type of paper.</p> <p>a Load the specified tray or feeder with a recommended type of paper.</p> <p>b Resend the print job.</p> <p>Do vertical voids appear on prints?</p>	Go to step 4.	The problem is solved.

Action	Yes	No
<p>Step 4</p> <p>a Redistribute the toner in the imaging unit.</p> <ol style="list-style-type: none"> 1 Remove the toner cartridge, and then the imaging unit. 2 Firmly shake the imaging unit. <p>Warning—Potential Damage: Do not expose the imaging unit to direct light for more than 10 minutes. Extended exposure to light may cause print quality problems.</p> <ol style="list-style-type: none"> 3 Reinstall the imaging unit, and then the cartridge. <p>b Resend the print job.</p> <p>Do vertical voids appear on prints?</p>	Go to step 5.	The problem is solved.
<p>Step 5</p> <p>Replace the imaging unit, and then resend the print job.</p> <p>Do vertical voids appear on prints?</p>	Contact technical support .	The problem is solved.

Toner specks appear on prints

Action	Yes	No
<p>Replace the imaging unit, and then resend the print job.</p> <p>Do toner specks appear on prints?</p>	Contact technical support .	The problem is solved.

Toner fog or background shading appears on prints

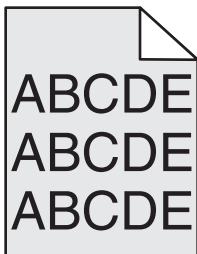

Action	Yes	No
<p>Step 1</p> <p>Reinstall the imaging unit.</p> <ol style="list-style-type: none"> a Remove, and then install the imaging unit. b Resend the print job. <p>Does fog or shading appear on prints?</p>	Go to step 2.	The problem is solved.

Action	Yes	No
<p>Step 2 Replace the imaging unit, and then resend the print job.</p> <p>Does fog or shading appear on prints?</p>	Contact technical support or your Dell printer dealer.	The problem is solved.

Toner rubs off

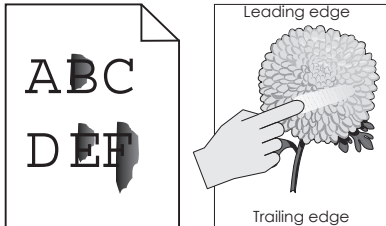

Action	Yes	No
<p>Step 1 From the Paper menu on the printer control panel, check the paper type, texture, and weight.</p> <p>Do the paper type, texture, and weight match the paper loaded in the tray?</p>	Go to step 2.	Specify the paper type, texture, and weight from the tray settings to match the paper loaded in the tray.
<p>Step 2 Resend the print job.</p> <p>Does the toner still rub off?</p>	Contact technical support or your Dell printer dealer.	The problem is solved.

Uneven print density

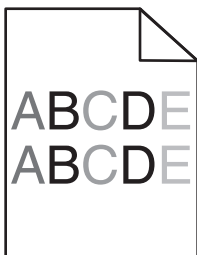

Action	Yes	No
<p>Replace the imaging unit, and then resend the print job.</p> <p>Is the print density uneven?</p>	Contact technical support .	The problem is solved.

Solving copy problems

- “Copier does not respond” on page 287

- “Scanner unit does not close” on page 287
- “Poor copy quality” on page 288
- “Partial document or photo copies” on page 289

Copier does not respond

Action	Yes	No
<p>Step 1 Check if an error or status message appears on the display.</p> <p>Does an error or status message appear?</p>	Clear the error or status message.	Go to step 2.
<p>Step 2 Check if the power cord is plugged into the printer and a properly grounded electrical outlet.</p> <p>Is the power cord plugged into the printer and a properly grounded electrical outlet?</p>	Go to step 3.	Connect the power cord to the printer and a properly grounded electrical outlet.
<p>Step 3 Turn off the printer, then wait for about 10 seconds, and then turn it back on.</p> <p>Did Performing Self Test and Ready appear?</p>	The problem is solved.	Contact technical support .

Scanner unit does not close

Action	Yes	No
<p>Check if there are no obstructions between the scanner unit and the printer.</p> <ul style="list-style-type: none"> a Lift the scanner unit. b Remove any obstruction that keeps the scanner unit open. c Lower the scanner unit. <p>Did the scanner unit close properly?</p>	The problem is solved.	Contact technical support .

Poor copy quality

Action	Yes	No
<p>Step 1 Check if an error or status message appears on the display.</p> <p>Does an error or status message appear?</p>	Clear the error or status message.	Go to step 2.
<p>Step 2 Check the quality of the original document.</p> <p>Is the quality of the original document satisfactory?</p>	Go to step 3.	Increase the scan resolution setting for a higher-quality output.
<p>Step 3 If dark marks appear on prints, then clean the scanner glass and the ADF glass using a clean, lint-free cloth dampened with water.</p> <p>Is the scanner glass clean?</p>	Go to step 4.	See “Cleaning the scanner glass” on page 210.
<p>Step 4 Send a print job, and then check for print quality problems.</p> <ul style="list-style-type: none"> a From the General Settings menu, adjust the Eco-Mode settings. b From the Copy menu, adjust the toner darkness. c If the print remains faded, then replace the toner cartridge. <p>Is the print quality satisfactory?</p>	Go to step 5.	See “Print quality problems” on page 268.
<p>Step 5 Check the placement of the document or photo.</p> <p>Make sure the document or photo is loaded facedown on the scanner glass in the upper left corner.</p> <p>Is the document or photo loaded correctly?</p>	Go to step 6.	Place the document or photo facedown on the scanner glass in the upper left corner.
<p>Step 6 Increase the scan resolution setting for a higher-quality output.</p> <p>Did the increased resolution produce a higher-quality output?</p>	The problem is solved.	Go to step 7.
<p>Step 7 Check the copy settings.</p> <p>From the Copy screen, check if the Content Type and Content Source settings are correct for the document being scanned.</p> <p>Are the Content Type and Content Source settings correct for the document being scanned?</p>	Go to step 8.	Change the Content Type and Content Source settings to match the document being scanned.

Action	Yes	No
<p>Step 8</p> <p>Check for patterns on print.</p> <p>a From the Copy screen, navigate to: Advanced Options > Advanced Imaging > Sharpness > select a lower setting</p> <p>b On the Copy screen, make sure no scaling is being selected.</p> <p>Do patterns appear on prints?</p>	Go to step 9.	The problem is solved.
<p>Step 9</p> <p>Check for missing or faded text on prints.</p> <p>a From the Copy screen, navigate to: Advanced Options > Advanced Imaging</p> <p>b Adjust the settings:</p> <ul style="list-style-type: none"> • Improve sharpness—Increase the sharpness setting. • Remove background—Reduce the current background removal setting. • Increase contrast—Increase the current setting. • Decrease shadow—Reduce the current setting. <p>Do prints have missing or faded text?</p>	Go to step 10.	The problem is solved.
<p>Step 10</p> <p>Check for washed-out or overexposed output.</p> <p>a From the Copy screen, navigate to: Advanced Options > Advanced Imaging</p> <p>b Adjust the settings of the following:</p> <ul style="list-style-type: none"> • Background removal—Reduce the current setting. • Shadow detail—Reduce the current background removal setting. <p>c Resend the copy job.</p> <p>Do pages show washed-out or overexposed prints?</p>	Contact technical support .	The problem is solved.

Partial document or photo copies

Action	Yes	No
<p>Step 1</p> <p>Check the placement of the document or photo.</p> <p>Make sure the document or photo is loaded facedown on the scanner glass in the upper left corner.</p> <p>Is the document or photo loaded correctly?</p>	Go to step 2.	Place the document or photo facedown on the scanner glass in the upper left corner.

Action	Yes	No
<p>Step 2</p> <p>Check if the paper size setting matches the size of the paper loaded in the tray.</p> <p>From the Paper menu on the printer control panel, check the Paper Size setting.</p> <p>Does the paper size setting match the size of the paper loaded in the tray.</p>	Go to step 3.	Change the paper size setting to match the paper loaded in the tray, or load the tray with paper that matches the paper size setting.
<p>Step 3</p> <p>a Specify the paper size. Depending on your operating system, specify the paper size in Printing Preferences or the Print dialog.</p> <p>b Resend the print job.</p> <p>Do copies print properly?</p>	The problem is solved.	Contact technical support .



Solving fax problems

- “Fax and e-mail functions are not set up” on page 290
- “Caller ID is not shown” on page 291
- “Cannot send or receive a fax” on page 291
- “Can send but not receive faxes” on page 293
- “Can receive but not send faxes” on page 294
- “Received fax has poor print quality” on page 295

Fax and e-mail functions are not set up

Notes:

- Before you troubleshoot, check if the fax cables are connected.
- The indicator light is blinking red until you set up fax and e-mail.

Action	Yes	No
<p>a From the home screen, navigate to:</p> <p> > Settings > General Settings > Run initial setup > Yes > Submit</p> <p>b Turn off the printer, and then turn it back on.</p> <p>The “Select your language” screen appears on the printer display.</p> <p>c Select a language, and then touch .</p> <p>d Select a country or region, and then touch Next.</p> <p>e Select a time zone, and then touch Next.</p> <p>f Select Fax and E-mail, and then touch Next.</p> <p>Are fax and e-mail functions set up?</p>	The problem is solved.	Contact technical support .

Caller ID is not shown

Action	Yes	No
<p>Contact your telephone company to check if your telephone line is subscribed to the caller ID service.</p> <p>Notes:</p> <ul style="list-style-type: none"> • If your region supports multiple caller ID patterns, then you may have to change the default setting. There are two settings available: FSK (pattern 1) and DTMF (pattern 2). • The availability of these settings in the Fax menu depends on whether your country or region supports multiple caller ID patterns. • Contact your telephone company to determine which pattern or switch setting to use. <p>Does the caller ID appear?</p>	<p>The problem is solved.</p>	<p>Contact technical support.</p>

Cannot send or receive a fax

Action	Yes	No
<p>Step 1</p> <p>Check if an error or status message appears on the display.</p> <p>Is there an error or status message on the display?</p>	<p>Clear the error or status message.</p>	<p>Go to step 2.</p>
<p>Step 2</p> <p>Check if the power cord is plugged into the printer and a properly grounded electrical outlet.</p> <p>Is the power cord plugged into the printer and a properly grounded electrical outlet?</p>	<p>Go to step 3.</p>	<p>Connect the power cord to the printer and a properly grounded electrical outlet.</p>
<p>Step 3</p> <p>Check the power.</p> <p>Check if the printer is plugged in and turned on, and if Ready appears on the display.</p> <p>Is the printer turned on, and does Ready appear on the display?</p>	<p>Go to step 4.</p>	<p>Turn on the printer, and then wait until Ready appears on the display.</p>
<p>Step 4</p> <p>Check the printer connections.</p> <p>If applicable, check if the cable connections for the following equipment are secure:</p> <ul style="list-style-type: none"> • Telephone • Handset • Answering machine <p>Are the cable connections secure?</p>	<p>Go to step 5.</p>	<p>Securely connect the cables.</p>

Action	Yes	No
<p>Step 5</p> <p>a Check the telephone wall jack.</p> <ol style="list-style-type: none"> 1 Plug the telephone cable into the wall jack. 2 Listen for a dial tone. 3 If you do not hear a dial tone, then plug a different telephone cable into the wall jack. 4 If you still do not hear a dial tone, then plug the telephone cable into a different wall jack. 5 If you hear a dial tone, then connect the printer to that wall jack. <p>b Try sending or receiving a fax.</p> <p>Can you send or receive a fax?</p>	<p>The problem is solved.</p>	<p>Go to step 6.</p>
<p>Step 6</p> <p>Check if the printer is connected to an analog phone service or the correct digital connector.</p> <p>The fax modem is an analog device. Certain devices can be connected to the printer so that digital telephone services can be used.</p> <ul style="list-style-type: none"> • If you are using an ISDN telephone service, then connect the printer to an analog telephone port (an R-interface port) on an ISDN terminal adapter. For more information and to request an R-interface port, contact your ISDN provider. • If you are using DSL, then connect to a DSL filter or router that will support analog use. For more information, contact your DSL provider. • If you are using a PBX telephone service, then make sure you are connecting to an analog connection on the PBX. If none exists, then consider installing an analog telephone line for the fax machine. <p>Is the printer connected to an analog phone service or the correct digital connector?</p>	<p>Go to step 7.</p>	<p>Connect the printer to an analog phone service or the correct digital connector.</p>
<p>Step 7</p> <p>Check for a dial tone.</p> <p>Did you hear a dial tone?</p>	<p>Go to step 8.</p>	<ul style="list-style-type: none"> • Try calling the fax number to make sure that it is working properly. • If the telephone line is being used by another device, then wait until the other device is finished before sending a fax. • If you are using the On Hook Dial feature, then turn up the volume to check if you hear a dial tone.

Action	Yes	No
<p>Step 8 Temporarily disconnect other equipment (such as answering machines, computers with modems, or telephone line splitters) between the printer and the telephone line, and then try sending or receiving a fax.</p> <p>Can you send or receive a fax?</p>	The problem is solved.	Go to step 9.
<p>Step 9 a Temporarily disable call waiting. Contact your telephone company to obtain the keypad sequence for temporarily disabling call waiting. b Try sending or receiving a fax.</p> <p>Can you send or receive a fax?</p>	The problem is solved.	Go to step 10.
<p>Step 10 a Temporarily disable voice mail service. For more information, contact your telephone company. Note: If you want to use both voice mail and the printer, then consider adding a second telephone line for the printer. b Try sending or receiving a fax.</p> <p>Can you send or receive a fax?</p>	The problem is solved.	Go to step 11.
<p>Step 11 Scan the original document one page at a time. a Dial the fax number. b Scan the document one page at a time.</p> <p>Can you send or receive a fax?</p>	The problem is solved.	Contact technical support .

Can send but not receive faxes

Action	Yes	No
<p>Step 1 Check the tray or feeder. If empty, then load paper in the tray or feeder.</p> <p>Can you receive faxes?</p>	The problem is solved.	Go to step 2.

Action	Yes	No
<p>Step 2 Check the ring count delay settings.</p> <p>a Open a Web browser, and then type the printer IP address in the address field.</p> <p>Notes:</p> <ul style="list-style-type: none"> • View the printer IP address on the printer home screen. The IP address appears as four sets of numbers separated by periods, such as 123.123.123.123. • If you are using a proxy server, then temporarily disable it to load the Web page correctly. <p>b Click Settings > Fax Settings > Analog Fax Setup.</p> <p>c In the “Rings to Answer” field, enter the number of times you want the phone to ring before the printer answers.</p> <p>d Click Submit.</p> <p>Can you receive faxes?</p>	<p>The problem is solved.</p>	<p>Go to step 3.</p>
<p>Step 3 Replace the toner cartridge. For more information, see the instruction sheet that came with the supply.</p> <p>Can you receive faxes?</p>	<p>The problem is solved.</p>	<p>Contact technical support.</p>

Can receive but not send faxes

Action	Yes	No
<p>Step 1 Check if the printer is in Fax mode.</p> <p>From the home screen, touch Fax to put the printer in Fax mode, and then send the fax.</p> <p>Note: The Multi Send application does not support the XPS output type. To use XPS, use the regular faxing method.</p> <p>Can you send faxes?</p>	<p>The problem is solved.</p>	<p>Go to step 2.</p>
<p>Step 2 Load the original document properly.</p> <p>Load the original document faceup, short edge first into the ADF tray or facedown on the scanner glass in the upper left corner.</p> <p>Note: Do not load postcards, photos, small items, transparencies, photo paper, or thin media (such as magazine clippings) into the ADF tray. Place these items on the scanner glass.</p> <p>Can you send faxes?</p>	<p>The problem is solved.</p>	<p>Go to step 3.</p>

Action	Yes	No
<p>Step 3 Set up the shortcut number properly.</p> <ul style="list-style-type: none"> • Check if the shortcut number has been set for the telephone number that you want to dial. • Dial the telephone number manually. <p>Can you send faxes?</p>	The problem is solved.	Contact technical support .

Received fax has poor print quality

Action	Yes	No
<p>Step 1 Ask the person who sent you the fax to:</p> <ol style="list-style-type: none"> Check if the quality of the original document is satisfactory. Increase the fax scan resolution, if possible. Resend the fax. <p>Is the fax print quality satisfactory?</p>	The problem is solved.	Go to step 2.
<p>Step 2 Decrease the incoming fax transmission speed.</p> <ol style="list-style-type: none"> Open a Web browser, and then type the printer IP address in the address field. <p>Notes:</p> <ul style="list-style-type: none"> • View the printer IP address on the printer home screen. The IP address appears as four sets of numbers separated by periods, such as 123.123.123.123. • If you are using a proxy server, then temporarily disable it to load the Web page correctly. • Print a network setup page or menu settings page, and then locate the IP address in the TCP/IP section. <ol style="list-style-type: none"> Click Settings > Fax Settings > Analog Fax Setup. In the Max Speed menu, click one of the following: <ul style="list-style-type: none"> • 2400 • 4800 • 9600 • 14400 • 33600 Click Submit, and then resend the fax. <p>Is the fax print quality satisfactory?</p>	The problem is solved.	Go to step 3.

Action	Yes	No
<p>Step 3 Replace the toner cartridge. When Cartridge low [88.xy] appears, replace the cartridge, and then resend the fax.</p> <p>Is the fax print quality satisfactory?</p>	<p>The problem is solved.</p>	<p>Contact technical support.</p>

Solving scanner problems

- “The scanner does not respond” on page 296
- “Scan job was not successful” on page 297
- “Scanner unit does not close” on page 298
- “Scanning takes too long or freezes the computer” on page 298
- “Poor scanned image quality” on page 299
- “Partial document or photo scans” on page 300
- “Cannot scan from a computer” on page 300

The scanner does not respond

Action	Yes	No
<p>Step 1 Check if the printer is turned on.</p> <p>Is the printer turned on?</p>	<p>Go to step 2.</p>	<p>Turn on the printer.</p>
<p>Step 2 Check if the printer cable is securely attached to the printer and the computer, print server, option, or other network device.</p> <p>Is the printer cable securely attached to the printer and the computer, print server, option, or other network device?</p>	<p>Go to step 3.</p>	<p>Connect the printer cable securely to the printer and the computer, print server, option, or other network device.</p>
<p>Step 3 Check if the power cord is plugged into the printer and a properly grounded electrical outlet.</p> <p>Is the power cord plugged into the printer and a properly grounded electrical outlet?</p>	<p>Go to step 4.</p>	<p>Connect the power cord to the printer and a properly grounded electrical outlet.</p>
<p>Step 4 Check if the electrical outlet is turned off by a switch or breaker.</p> <p>Is the electrical outlet turned off by a switch or breaker?</p>	<p>Turn on the switch or reset the breaker.</p>	<p>Go to step 5.</p>

Action	Yes	No
<p>Step 5 Check if the printer is plugged into any surge protectors, uninterruptible power supplies, or extension cords.</p> <p>Is the printer plugged into any surge protectors, uninterruptible power supplies, or extension cords?</p>	Connect the printer power cord directly to a properly grounded electrical outlet.	Go to step 6.
<p>Step 6 Check other electrical equipment plugged into the outlet.</p> <p>Are the other electrical equipment working?</p>	Unplug the other electrical equipment and turn on the printer. If the printer does not work, then reconnect the other electrical equipment and then go to step 6.	Go to step 7.
<p>Step 7 Turn off the printer, then wait for about 10 seconds, and then turn the printer back on.</p> <p>Are the printer and scanner working?</p>	The problem is solved.	Contact technical support .

Scan job was not successful

Action	Yes	No
<p>Step 1 Check the cable connections. Make sure the Ethernet or USB cable is securely connected to the computer and the printer.</p> <p>Are the cables securely connected?</p>	Go to step 2.	Connect the cables properly.
<p>Step 2 Check if the file name is already in use.</p> <p>Is the file name already in use?</p>	Change the file name.	Go to step 3.
<p>Step 3 Check if the document or photo you want to scan is open in another application or being used by another user.</p> <p>Is the file you want to scan open in another application or being used by another user?</p>	Close the file you are scanning.	Go to step 4.
<p>Step 4 Check if either the Append time stamp or the Overwrite existing file check box is selected in the destination configuration settings.</p> <p>Is the Append time stamp or Overwrite existing file check box selected in the destination configuration settings?</p>	Go to step 5.	Select the Append time stamp or Overwrite existing file check box in the destination configuration settings.

Action	Yes	No
<p>Step 5 From the Flash Drive menu, reduce the scan resolution settings, and then resend the scan job.</p> <p>Does the job scan?</p>	The problem is solved.	Go to step 6.
<p>Step 6 Check the scan settings. From the Scan screen, make sure the Content Type and Content Source settings are correct for the document being scanned.</p> <p>Are the Content Type and Content Source settings correct for the document being scanned?</p>	The problem is solved.	Change the Content Type and Content Source settings to match the document being scanned.

Scanner unit does not close

Action	Yes	No
<p>Check if there are obstructions in the scanner unit.</p> <ul style="list-style-type: none"> a Lift the scanner unit. b Remove any obstruction keeping the scanner unit open. c Lower the scanner unit. <p>Did the scanner unit close correctly?</p>	The problem is solved.	Contact technical support .

Scanning takes too long or freezes the computer

Action	Yes	No
<p>Step 1 Check if other applications are interfering with the scan. Close all applications that are not being used.</p> <p>Does scanning still take too long or freeze the computer?</p>	Go to step 2.	The problem is solved.
<p>Step 2 Select a lower scan resolution.</p> <p>Does scanning still take too long or freeze the computer?</p>	Contact technical support .	The problem is solved.

Poor scanned image quality

Action	Yes	No
<p>Step 1 Check if an error message appears on the display.</p> <p>Is there an error message on the printer display?</p>	Clear the error message.	Go to step 2.
<p>Step 2 Check the quality of the original document.</p> <p>Is the quality of the original document satisfactory?</p>	Go to step 3.	Increase the scan resolution settings for a higher-quality output.
<p>Step 3 Clean the scanner glass and the ADF glass using a clean, lint-free cloth dampened with water.</p> <p>Is the scanner glass clean?</p>	Go to step 4.	See “Cleaning the scanner glass” on page 210.
<p>Step 4 Check the placement of the document or photo. Make sure the document or photo is loaded facedown on the scanner glass in the upper left corner.</p> <p>Is the document or photo loaded correctly?</p>	Go to step 5.	Place the document or photo facedown on the scanner glass in the upper left corner.
<p>Step 5 Send a print job, and then check for print quality problems.</p> <ul style="list-style-type: none"> • From the General Settings menu, adjust the Eco-Mode settings. • From the Copy menu, adjust the toner darkness. • When the print becomes faded, replace the toner cartridge. <p>Is the print quality satisfactory?</p>	Go to step 6.	See “Print quality problems” on page 268.
<p>Step 6 Increase the scan resolution settings for a higher-quality output.</p> <p>Did the increased resolution produce a higher-quality output?</p>	Problem solved.	Go to step 7.
<p>Step 7 Check the scan settings. From the Scan screen, make sure the Content Type and Content Source settings are correct for the document being scanned.</p> <p>Are the Content Type and Content Source settings correct for the document being scanned?</p>	Contact technical support .	Change the Content Type and Content Source settings to match the document being scanned.

Partial document or photo scans

Action	Yes	No
<p>Check the placement of the document or photo. Make sure the document or photo is loaded facedown on the scanner glass in the upper left corner.</p> <p>Is the document or photo loaded correctly?</p>	<p>Contact technical support.</p>	<p>Load the document or photo loaded facedown on the scanner glass in the upper left corner.</p>

Cannot scan from a computer

Action	Yes	No
<p>Step 1 Make sure the printer is turned on and that Ready appears on the printer display before scanning a job.</p> <p>Does Ready appear before scanning the job?</p>	<p>Go to step 3.</p>	<p>Go to step 2.</p>
<p>Step 2 Turn off the printer, then wait for about 10 seconds, and then turn the printer back on.</p> <p>Is there an error message on the printer display?</p>	<p>Clear the error message.</p>	<p>Go to step 3.</p>
<p>Step 3 Check the cable connections between the printer and the print server to make sure they are secure. For more information, see the setup documentation that came with the printer.</p> <p>Are the cable connections between the printer and the print server secure?</p>	<p>Contact technical support.</p>	<p>Tighten the cable connections.</p>

Solving home screen application problems

An application error has occurred

Action	Yes	No
<p>Step 1 Check the system log for relevant details.</p> <p>a Open a Web browser, and then type the printer IP address in the address field.</p> <p>If you do not know the IP address of the printer, then you can:</p> <ul style="list-style-type: none"> • View the IP address on the printer home screen. • Print a network setup page or the menu settings pages, and then locate the IP address in the TCP/IP section. <p>Note: An IP address appears as four sets of numbers separated by periods, such as 123.123.123.123.</p> <p>b Click Settings > Apps > Apps Management > System tab > Log.</p> <p>c From the Filter menu, select an application status.</p> <p>d From the Application menu, select an application, and then click Submit.</p> <p>Does an error message appear in the log?</p>	Go to step 2.	Contact technical support .
<p>Step 2 Resolve the error.</p> <p>Is the application working now?</p>	The problem is solved.	Contact technical support .

Embedded Web Server does not open

Action	Yes	No
<p>Step 1 Make sure the printer IP address is correct.</p> <p>View the printer IP address:</p> <ul style="list-style-type: none"> • From the printer home screen • From the TCP/IP section in the Network/Ports menu • By printing a network setup page or menu settings page, and then finding the TCP/IP section <p>Note: An IP address appears as four sets of numbers separated by periods, such as 123.123.123.123.</p> <p>Is the printer IP address correct?</p>	Go to step 2.	Type the correct printer IP address in the address field of your Web browser. <p>Note: Depending on the network settings, you may need to type “https://” instead of “http://” before the printer IP address to access the Embedded Web Server.</p>
<p>Step 2 Check if the printer is turned on.</p> <p>Is the printer turned on?</p>	Go to step 3.	Turn on the printer.

Action	Yes	No
<p>Step 3 Check if the network connection is working.</p> <p>Is the network connection working?</p>	Go to step 4.	Contact your system support person.
<p>Step 4 Make sure the cable connections to the printer and print server are secure. For more information, see the setup documentation that came with the printer.</p> <p>Are the cable connections to the printer and print server secure?</p>	Go to step 5.	Tighten the cable connection.
<p>Step 5 Temporarily disable the Web proxy servers.</p> <p>Note: Proxy servers may block or restrict you from accessing certain Web sites including the Embedded Web Server.</p> <p>Are the Web proxy servers disabled?</p>	Go to step 6.	Contact your system support person.
<p>Step 6 Access the Embedded Web Server again by typing the correct IP address in the address field.</p> <p>Did the Embedded Web Server open?</p>	The problem is solved.	Contact technical support .

Contacting technical support

When you call technical support, describe the problem you are experiencing, the message on the printer display, and the troubleshooting steps you have already taken to find a solution.

You need to know your printer model type and the service tag number or express service code. For more information, see the label on the inside top front cover or at the back of the printer. The service tag number is also listed on the menu settings page.

For more information, check the Dell support Web site at www.dell.com/support/printers.

Appendix

Dell Technical Support Policy

Technician-assisted technical support requires the cooperation and participation of the customer in the troubleshooting process and provides for restoration of the Operating System, application software and hardware drivers to the original default configuration as shipped from Dell, as well as the verification of appropriate functionality of the printer and all Dell-installed hardware. In addition to this technician assisted technical support, online technical support is available at Dell Support. Additional technical support options may be available for purchase.

Dell provides limited technical support for the printer and any Dell-installed software and peripherals. Support for third-party software and peripherals is provided by the original manufacturer, including those purchased and/or installed through Software & Peripherals (DellWare), ReadyWare, and Custom Factory Integration (CFI/DellPlus).

Contacting Dell

You can access Dell Support at www.dell.com/support/printers.

You can contact Dell electronically using the following addresses:

- World Wide Web

www.dell.com/

www.dell.com/ap/ (Asian/Pacific countries only)

www.dell.com/jp/ (Japan only)

www.euro.dell.com (Europe only)

www.dell.com/la/ (Latin American and Caribbean countries)

www.dell.ca (Canada only)

- Anonymous file transfer protocol (FTP)

[ftp.dell.com](ftp://ftp.dell.com)

Log in as user: anonymous, and use your email address as your password.

- Electronic Support Service

mobile_support@us.dell.com

support@us.dell.com

la-techsupport@dell.com (Latin America and Caribbean countries only)

apsupport@dell.com (Asian/Pacific countries only)

support.jp.dell.com (Japan only)

support.euro.dell.com (Europe only)

- Electronic Quote Service

apmarketing@dell.com (Asian/Pacific countries only)

sales_canada@dell.com (Canada only)

Warranty and Return Policy

Dell Inc. (“Dell”) manufactures its hardware products from parts and components that are new or equivalent to new in accordance with industry-standard practices. For information about the Dell warranty for your printer, refer to the *Product Information Guide*.

Index

Numerics

- 250-sheet tray
 - installing 42
- 550-sheet tray
 - installing 42

Symbols

- [x]-page jam, remove all pages from the output bin. Leave paper in bin. [45y.xx] 235
- [x]-page jam, clear manual feeder. [25y.xx] 233
- [x]-page jam, clear standard bin. [20y.xx] 227
- [x]-page jam, open automatic feeder top cover. [28y.xx] 226
- [x]-page jam, open front door. [20y.xx] 229
- [x]-page jam, open rear door. [20y.xx] 227
- [x]-page jam, open tray [x]. [24y.xx] 234
- [x]-page jam, remove tray 1 to clear duplex. [23y.xx] 232

A

- accessing Status Monitor Center 221
- accessing the Embedded Web Server 20
- Active NIC menu 141
- adapter plug 108
- adding hardware options
 - print driver 44
- ADF
 - copying using 81
- ADF separator roller
 - ordering 212
- adjusting brightness
 - Embedded Web Server 204
 - printer control panel 204
- adjusting copy quality 86
- adjusting display brightness 204
- adjusting Sleep mode 202
- adjusting toner darkness 74
- advanced options
 - fax 121

- FTP 91
- FTP options 128
- advanced options, touch-screen
 - e-mail 98
- AirPrint
 - using 76
- answering machine
 - setting up 101
- AppleTalk menu 146
- applications
 - home screen 22
 - understanding 21
- attaching cables 45
- available internal options 27
- avoiding jams 69
- avoiding paper jams 224

B

- blocking junk faxes 117
- buttons, printer control panel 15
- buttons, touch screen
 - using 18

C

- cables
 - Ethernet 45
 - USB 45
- canceling a print job
 - from a computer 80
 - from the printer control panel 80
- canceling an e-mail 96
- cannot open Embedded Web Server 301
- Card Copy
 - setting up 22
- card stock
 - loading, multipurpose feeder 56
 - tips 66
- Cartridge low [88.xy] 240
- Cartridge nearly low [88.xy] 240
- Cartridge very low, [x] estimated pages remain [88.xy] 240
- Change [paper source] to [custom string] load [orientation] 240
- Change [paper source] to [custom type name] load [orientation] 240
- Change [paper source] to [paper size] load [orientation] 240
- Change [paper source] to [paper type] [paper size] load [orientation] 241
- Check tray [x] connection 241
- checking an unresponsive printer 254
- checking status of parts and supplies 211
- checking the status of parts and supplies 211
- checking the virtual display
 - using the Embedded Web Server 221
- cleaning
 - exterior of the printer 209
 - scanner glass 210
 - cleaning the printer 209
- Close finisher rear door 241
- Close flatbed cover and load originals if restarting job [2yy.xx] 242
- Close front door 241
- Close rear door 241
- collate
 - copy options 91
- collating copies 86
- color quality troubleshooting
 - prints on color transparencies appear dark when projected 271
- Complex page, some data may not have printed [39] 242
- confidential data
 - information on securing 208
- confidential jobs
 - modifying print settings 79
- confidential print jobs 78
 - printing from a Macintosh computer 78
 - printing from Windows 78
- Confidential Print menu 151
- Configuration change, some held jobs were not restored [57] 242
- configuration information
 - wireless network 46
- Configure MP menu 133
- configuring
 - supply notifications, imaging unit 222

- supply notifications, maintenance kit 222
 - supply notifications, toner cartridge 222
 - configuring e-mail settings 92
 - configuring port settings 49
 - configuring supply notifications 222
 - connecting printer to distinctive ring service 112
 - connecting to a wireless network
 - using PIN (Personal Identification Number) method 48
 - using Push Button Configuration method 48
 - using the Embedded Web Server 49
 - using wireless setup wizard 47
 - conservation settings
 - brightness, adjusting 204
 - Eco-Mode 200
 - Hibernate Timeout 203
 - Quiet Mode 201
 - Schedule Power Modes 203
 - Sleep Mode 202
 - contacting technical support 302
 - content
 - e-mail settings 97
 - content source
 - e-mail settings 97
 - fax options 119
 - content type
 - e-mail settings 97
 - fax options 119
 - control panel, printer 15
 - indicator light 15
 - Sleep button light 15
 - controller board
 - accessing 27
 - copies
 - copy options 91
 - copy job, canceling
 - using the ADF 89
 - using the scanner glass 89
 - copy options
 - collate 91
 - copies 91
 - darkness 90
 - save as shortcut 91
 - sides (duplex) 90
 - copy quality
 - adjusting 86
 - copy screen
 - content source 91
 - content type 91
 - options 90
 - Copy Settings menu 163
 - copy troubleshooting
 - copier does not respond 287
 - partial document or photo copies 289
 - poor copy quality 288
 - poor scanned image quality 299
 - scanner unit does not close 287, 298
 - copying
 - adding an overlay message 89
 - adjusting quality 86
 - canceling a copy job 89, 90
 - collating copies 86
 - custom job 88
 - different paper sizes 84
 - enlarging 85
 - inserting a header or footer 89
 - multiple pages on one sheet 87
 - on both sides of the paper (duplexing) 85
 - on letterhead 83
 - on transparencies 82
 - photos 82
 - placing separator sheets between copies 87
 - quick copy 81
 - reducing 85
 - selecting a tray 84
 - to a different size 83
 - using the ADF 81
 - using the scanner glass 82
 - copying different paper sizes 84
 - copying multiple pages on one sheet 87
 - copying on both sides of the paper (duplexing) 85
 - copying on transparencies 82
 - creating a fax destination shortcut
 - using the Embedded Web Server 116
 - creating an FTP shortcut
 - using the Embedded Web Server 122
 - creating custom name
 - paper type 62
 - custom name
 - configuring 63
 - Custom Names menu 138
 - custom paper type name
 - assigning 63
 - Custom Scan Sizes menu 139
 - Custom Type [x]
 - changing paper type 63
 - creating custom name 62
 - Custom Types menu 138
- ## D
- darkness
 - copy options 90
 - e-mail options 97
 - fax options 120
 - scan options 126
 - date and time, fax setting 113
 - daylight saving time, setting 113
 - Default Source menu 130
 - Defective flash detected [51] 242
 - delayed send
 - fax options 120
 - Dell Mobile Print
 - using 77
 - different paper sizes, copying 84
 - Digital Subscriber Line (DSL)
 - fax setup 105
 - digital telephone service
 - fax setup 107
 - directory list
 - printing 80
 - Disk full 62 242
 - Disk must be formatted for use in this device 243
 - disk wiping 206
 - display troubleshooting
 - printer display is blank 256
 - display, printer control panel 15
 - adjusting brightness 204
 - disposing of printer hard disk 205
 - distinctive ring service, fax
 - connecting to 112
 - documents, printing
 - from Macintosh 74
 - from Windows 74
 - DSL filter 105
 - duplexing 85
- ## E
- Eco-Mode setting 200
 - Edit Security Setups menu 149

- Embedded Web Server
 - accessing 13, 20
 - checking the status of parts 211
 - checking the status of supplies 211
 - creating a fax destination
 - shortcut 116
 - creating an FTP shortcut 122
 - creating e-mail shortcuts 93
 - functions 13
 - initial fax setup 100
 - modifying confidential print settings 79
 - problem accessing 301
 - scanning to a computer using 124
 - setting up e-mail alerts 222
 - using 13
- Embedded Web Server—Security: Administrator's Guide
 - where to find 208
- encrypting the printer hard disk 207
- enlarging a copy 85
- envelopes
 - loading, multipurpose feeder 56
 - tips on using 65
- environmental settings
 - display brightness, adjusting 204
 - Eco-Mode 200
 - Hibernate Timeout 203
 - Quiet Mode 201
 - Schedule Power Modes 203
 - Sleep Mode 202
- Erase Temporary Data Files
 - menu 152
- erasing hard disk memory 206
- erasing non-volatile memory 206
- erasing volatile memory 205
- Error reading USB drive. Remove USB. 243
- Error reading USB hub. Remove hub. 243
- Ethernet network
 - preparing to set up for Ethernet printing 46
- Ethernet port 45
- Ethernet setup
 - preparing for an 46
- exporting a configuration using the Embedded Web Server 25
- exterior of the printer
 - cleaning 209
- e-mail
 - canceling 96
- e-mail alerts
 - low supply levels 222
 - paper jam 222
 - setting up 222
- e-mail function
 - setting up 92
- e-mail options
 - darkness 97
 - message 96
 - original size 96
 - page setup 98
 - recipient(s) 96
 - resolution 97
 - send as 97
 - subject 96
- e-mail screen
 - advanced options 98
 - options 96, 98
- E-mail Settings menu 174
- e-mail shortcuts, creating using the Embedded Web Server 93
- e-mail, sending
 - using a shortcut number 94
 - using the address book 95
- e-mailing
 - adding message line 95
 - adding subject line 95
 - changing output file type 95
 - configuring e-mail settings 92
 - creating shortcuts using the Embedded Web Server 93
 - creating shortcuts using the printer control panel 93
 - setting up e-mail function 92
 - using a shortcut number 94
 - using the address book 95
 - using the printer control panel 94
- F**
- factory defaults
 - restoring 223
- fax
 - sending 114, 115
- fax and e-mail functions
 - setting up 290
- fax and e-mail functions are not set up 290
- fax log
 - viewing 117
- Fax memory full 243
- Fax Mode (Analog Fax Setup) menu 166
- fax name, setting 112
- fax number, setting 112
- fax options
 - content source 119
 - content type 119
 - darkness 120
 - delayed send 120
 - page setup 120
 - resolution 120
 - scan preview 120
- Fax partition inoperative. Contact system administrator. 243
- fax ports 45
- fax screen
 - advanced options 121
- Fax server 'To Format' not set up. Contact system administrator. 243
- fax setup
 - country- or region-specific 108
 - digital telephone service 107
 - DSL connection 105
 - standard telephone line connection 101
 - VoIP 106
- Fax Station Name not set up. Contact system administrator. 243
- Fax Station Number not set up. Contact system administrator. 244
- fax troubleshooting
 - caller ID is not shown 291
 - can receive but not send faxes 294
 - can send but not receive faxes 293
 - cannot send or receive a fax 291
 - received fax has poor print quality 295
- faxing
 - blocking junk faxes 117
 - canceling a fax job 118
 - changing resolution 116
 - configuring the printer to observe daylight saving time 113
 - creating shortcuts using the Embedded Web Server 116
 - creating shortcuts using the printer control panel 116

- distinctive ring service 112
 - fax setup 100
 - forwarding faxes 119
 - holding faxes 118
 - making a fax lighter or darker 117
 - sending a fax at a scheduled time 115
 - sending using the printer control panel 113
 - setting the date and time 113
 - setting the fax number 112
 - setting the outgoing fax name 112
 - viewing a fax log 117
 - file name
 - scan options 126
 - finding more information about the printer 9
 - finding printer IP address 20
 - finisher
 - finishing features 72
 - supported paper sizes 72
 - finisher features 72
 - Finishing menu 189
 - firmware card 27
 - flash drive
 - printing from 75
 - Flash Drive menu 183
 - flash drives
 - supported file types 77
 - font sample list
 - printing 80
 - Forms and Favorites
 - setting up 22
 - forwarding faxes 119
 - FTP
 - FTP options 126
 - FTP address
 - creating shortcuts using the printer control panel 123
 - FTP address, scanning to
 - using a shortcut number 123
 - using the printer control panel 123
 - FTP options
 - advanced options 128
 - FTP 126
 - FTP screen
 - advanced options 91
 - FTP Settings menu 179
- G**
- green settings
 - Eco-Mode 200
 - Hibernate Timeout 203
 - Quiet Mode 201
 - Schedule Power Modes 203
- H**
- hardware options, adding
 - print driver 44
 - held jobs 78
 - printing from a Macintosh computer 78
 - printing from Windows 78
 - Help menu 199
 - Hibernate Timeout
 - setting 203
 - hiding icons on the home screen 21
 - holding faxes 118
 - home screen
 - customizing 21
 - hiding icons 21
 - showing icons 21
 - home screen applications
 - configuring 22
 - finding information 22
 - home screen buttons and icons
 - description 16
 - HTML menu 197
- I**
- icons on the home screen
 - hiding 21
 - showing 21
 - Image menu 198
 - imaging unit
 - ordering 212
 - replacing 214
 - Imaging unit low [84.xy] 244
 - Imaging unit nearly low [84.xy] 244
 - Imaging unit very low, [x] estimated pages remain [84.xy] 244
 - importing a configuration
 - using the Embedded Web Server 25
 - in finisher rear door
 - paper jams, clearing 235
 - Incompatible tray [x] [59] 244
 - Incorrect paper size, open [paper source] [34] 244
- J**
- initial fax setup 100
 - using the Embedded Web Server 100
 - inserting a header or footer 89
 - installing an Internal Solutions Port 32
 - installing an optional card 30
 - installing options
 - order of installation 42
 - installing printer 44
 - installing printer hard disk 39
 - installing the 250-sheet tray 42
 - installing the 550-sheet tray 42
 - Insufficient memory for Flash Memory Defragment operation [37] 245
 - Insufficient memory to collate job [37] 245
 - Insufficient memory to support Resource Save feature [35] 245
 - Insufficient memory, some Held Jobs were deleted [37] 245
 - Insufficient memory, some held jobs will not be restored [37] 245
 - internal options 27
 - Internal Solutions Port
 - changing port settings 49
 - installing 32
 - troubleshooting 259
 - IP address of computer
 - finding 20
 - IP address, printer
 - finding 20
 - IPv6 menu 144
- J**
- jams
 - accessing 225
 - avoiding 224
 - understanding messages 225
 - jams, clearing
 - finisher bin 235
 - in automatic document feeder top cover 226
 - in duplex area 232
 - in front door 229
 - in manual feeder 233
 - in rear door 227
 - in standard bin 227
 - in staple access door 235
 - in tray [x] 234
 - Job Accounting menu 192

L

- labels, paper
 - tips 66
- letterhead
 - copying on 83
 - loading, multipurpose feeder 56
 - tips on using 65
- light, indicator 15
- line filter 105
- linking trays 62, 63
- Load [paper source] with [custom string] [paper orientation] 246
- Load [paper source] with [custom type name] [paper orientation] 245
- Load [paper source] with [paper size] [paper orientation] 246
- Load [paper source] with [paper type] [paper size] [paper orientation] 246
- Load Manual Feeder with [custom string] [paper orientation] 247
- Load Manual Feeder with [custom type name] [paper orientation] 246
- Load Manual Feeder with [paper size] [paper orientation] 247
- Load manual feeder with [paper type] [paper size] [paper orientation] 247
- loading
 - multipurpose feeder 56
 - trays 51
- loading the optional tray 51
- loading the standard tray 51

M

- maintenance kit
 - ordering 212
- Maintenance kit low [80.xy] 247
- Maintenance kit nearly low [80.xy] 247
- Maintenance kit very low, [x] estimated pages remain [80.xy] 247
- making copies using paper from selected tray 84
- managing printer messages 221
- memory
 - types installed on printer 205
- memory card 27
 - installing 29
 - troubleshooting 259

- Memory full [38] 248
- Memory full, cannot print faxes 248
- Memory full, cannot send faxes 248
- menu settings page
 - printing 50
- menus
 - Active NIC 141
 - AppleTalk 146
 - Confidential Print 151
 - Configure MP 133
 - Copy Settings 163
 - Custom Names 138
 - Custom Scan Sizes 139
 - Custom Types 138
 - Default Source 130
 - Edit Security Setups 149
 - Erase Temporary Data Files 152
 - E-mail Settings 174
 - Fax Mode (Analog Fax Setup) 166
 - Finishing 189
 - Flash Drive 183
 - FTP Settings 179
 - Help 199
 - HTML 197
 - Image 198
 - IPv6 144
 - Job Accounting 192
 - list of 129
 - Miscellaneous Security Settings 150
 - Network [x] 141
 - Network Card 143
 - Network Reports 142
 - Paper Loading 137
 - Paper Size/Type 130
 - Paper Texture 134
 - Paper Weight 135
 - PCL Emul 195
 - PDF 194
 - PostScript 194
 - Quality 191
 - Reports 140
 - Security Audit Log 152
 - Set Date/Time 153
 - Settings 187
 - SMTP Setup menu 148
 - Standard Network 141
 - Standard USB 146
 - Substitute Size 134
 - TCP/IP 143

- Universal Setup 139
- Utilities 193
- Wireless 145
- XPS 194
- message
 - e-mail options 96
- Miscellaneous Security Settings menu 150
- mobile device
 - printing from 76, 77
- moving the printer 10, 219
- Multi Send
 - adding a profile 24
 - setting up 24
- multipurpose feeder
 - loading 56
- MyShortcut
 - about 23

N

- Network [x] menu 141
- Network [x] software error [54] 248
- Network Card menu 143
- Network Reports menu 142
- network setup page
 - printing 50
- No analog phone line connected to modem, fax is disabled. 248
- Non-Dell [supply type], see User's Guide [33.xy] 248
- non-volatile memory 205
 - erasing 206
- Not enough free space in flash memory for resources [52] 249
- number of remaining pages
 - estimate 211

O

- optional card
 - installing 30
- optional tray
 - loading 51
- options
 - 250-sheet tray, installing 42
 - 550-sheet tray, installing 42
 - firmware cards 27
 - Internal Solutions Port, installing 32
 - memory card 29
 - memory cards 27

- printer hard disk, installing 39
- printer hard disk, removing 41
- options, copy screen
 - copy from 90
 - scale 90
- options, touch-screen
 - copy 90
 - e-mail 96, 98
- ordering
 - imaging unit 212
 - maintenance kit 212
- ordering supplies
 - toner cartridges 212
 - using Printer Home 211
- original size
 - e-mail options 96
 - scan options 126
- output file type
 - changing 95
- P**
- page setup
 - e-mail options 98
 - fax options 120
 - scan options 127
- paper
 - characteristics 67
 - different sizes, copying 84
 - letterhead 68
 - loading, multipurpose feeder 56
 - preprinted forms 68
 - recycled 69
 - saving 87
 - selecting 68
 - storing 69
 - unacceptable 68
 - Universal size setting 51
- Paper changes needed 249
- paper feed troubleshooting
 - message remains after jam is cleared 261
- paper jams
 - avoiding 224
- paper jams, clearing
 - finisher bin 235
 - in automatic document feeder top cover 226
 - in duplex area 232
 - in finisher rear door 235
 - in front door 229
 - in manual feeder 233
 - in rear door 227
 - in standard bin 227
 - in staple access door 235
 - in tray [x] 234
- Paper Loading menu 137
- paper size
 - setting 51
- Paper Size/Type menu 130
- paper stop, using 61
- Paper Texture menu 134
- paper type
 - setting 51
- paper types
 - supported by printer 71
 - where to load 71
- Paper Weight menu 135
- paper weights
 - supported by printer 71
- Parallel port [x] disabled [56] 249
- parts
 - checking status 211
 - checking, from printer control panel 211
 - checking, using the Embedded Web Server 211
- PCL Emul menu 195
- PDF menu 194
- Personal Identification Number method
 - using 48
- phone splitter 106
- photos
 - copying 82
- placing separator sheets between copies 87
- port settings
 - configuring 49
- PostScript menu 194
- preparing to set up the printer on an Ethernet network 46
- print driver
 - hardware options, adding 44
- print irregularities 275
- print job
 - canceling, from computer 80
- print quality
 - cleaning the scanner glass 210
- print quality troubleshooting
 - blank pages 269
 - characters have jagged edges 268
 - clipped pages or images 270
 - gray background on prints 272
 - horizontal voids appear on prints 283
 - print irregularities 275
 - print is too dark 277
 - print is too light 278
 - printer is printing solid black pages 280
 - repeating print defects appear on prints 276
 - shadow images appear on prints 271
 - skewed print 279
 - streaked horizontal lines appear on prints 281
 - streaked vertical lines 282
 - toner fog or background shading 285
 - toner rubs off 286
 - toner specks appear on prints 285
 - transparency print quality is poor 281
 - uneven print density 286
 - white streaks 284
- print troubleshooting
 - error reading flash drive 262
 - held jobs do not print 264
 - incorrect characters print 266
 - incorrect margins on prints 273
 - jammed pages are not reprinted 261
 - job prints from wrong tray 266
 - job prints on wrong paper 266
 - jobs do not print 262
 - Large jobs do not collate 267
 - multiple-language PDF files do not print 261
 - paper curl 274
 - paper frequently jams 260
 - print job takes longer than expected 265
 - tray linking does not work 267
 - unexpected page breaks occur 268
- printer 44
 - basic model 11
 - finishing features 72
 - fully configured 11
 - minimum clearances 10
 - moving 10, 219
 - selecting a location 10
 - shipping 220
- printer configurations 11

- printer control panel 15
 - factory defaults, restoring 223
 - indicator light 15
 - Sleep button light 15
- printer control panel, virtual display
 - using the Embedded Web Server 221
- Printer had to restart. Last job may be incomplete. 249
- printer hard disk
 - disposing of 205
 - encrypting 207
 - installing 39
 - removing 41
 - wiping 206
- printer hard disk encryption 207
- printer hard disk memory
 - erasing 206
- printer information
 - where to find 9
- printer IP address
 - finding 20
- printer is printing blank pages 269
- printer messages
 - [x]-page jam, remove all pages from the output bin. Leave paper in bin. [45y.xx] 235
 - [x]-page jam, clear manual feeder. [25y.xx] 233
 - [x]-page jam, clear standard bin. [20y.xx] 227
 - [x]-page jam, open automatic feeder top cover. [28y.xx] 226
 - [x]-page jam, open front door. [20y.xx] 229
 - [x]-page jam, open rear door. [20y.xx] 227
 - [x]-page jam, open tray [x]. [24y.xx] 234
 - [x]-page jam, remove tray 1 to clear duplex. [23y.xx] 232
- Cartridge low [88.xy] 240
- Cartridge nearly low [88.xy] 240
- Cartridge very low, [x] estimated pages remain [88.xy] 240
- Change [paper source] to [custom string] load [orientation] 240
- Change [paper source] to [custom type name] load [orientation] 240
- Change [paper source] to [paper size] load [orientation] 240
- Change [paper source] to [paper type] [paper size] load [orientation] 241
- Check tray [x] connection 241
- Close finisher rear door 241
- Close flatbed cover and load originals if restarting job [2yy.xx] 242
- Close front door 241
- Close rear door 241
- Complex page, some data may not have printed [39] 242
- Configuration change, some held jobs were not restored [57] 242
- Defective flash detected [51] 242
- Disk full 62 242
- Disk must be formatted for use in this device 243
- Disk near full. Securely clearing disk space. 243
- Error reading USB drive. Remove USB. 243
- Error reading USB hub. Remove hub. 243
- Fax memory full 243
- Fax partition inoperative. Contact system administrator. 243
- Fax server 'To Format' not set up. Contact system administrator. 243
- Fax Station Name not set up. Contact system administrator. 243
- Fax Station Number not set up. Contact system administrator. 244
- Imaging unit low [84.xy] 244
- Imaging unit nearly low [84.xy] 244
- Imaging unit very low, [x] estimated pages remain [84.xy] 244
- Incompatible tray [x] [59] 244
- Incorrect paper size, open [paper source] [34] 244
- Insufficient memory for Flash Memory Defragment operation [37] 245
- Insufficient memory to collate job [37] 245
- Insufficient memory to support Resource Save feature [35] 245
- Insufficient memory, some Held Jobs were deleted [37] 245
- Insufficient memory, some held jobs will not be restored [37] 245
- Load [paper source] with [custom string] [paper orientation] 246
- Load [paper source] with [custom type name] [paper orientation] 245
- Load [paper source] with [paper size] [paper orientation] 246
- Load [paper source] with [paper type] [paper size] [paper orientation] 246
- Load Manual Feeder with [custom string] [paper orientation] 247
- Load Manual Feeder with [custom type name] [paper orientation] 246
- Load Manual Feeder with [paper size] [paper orientation] 247
- Load manual feeder with [paper type] [paper size] [paper orientation] 247
- Maintenance kit low [80.xy] 247
- Maintenance kit nearly low [80.xy] 247
- Maintenance kit very low, [x] estimated pages remain [80.xy] 247
- managing 221
- Memory full [38] 248
- Memory full, cannot print faxes 248
- Memory full, cannot send faxes 248
- Network [x] software error [54] 248
- No analog phone line connected to modem, fax is disabled. 248
- Non-Dell [supply type], see User's Guide [33.xy] 248
- Not enough free space in flash memory for resources [52] 249
- Paper changes needed 249
- Parallel port [x] disabled [56] 249
- Printer had to restart. Last job may be incomplete. 249

Reinstall missing or unresponsive cartridge [31.xy] 250
 Reinstall missing or unresponsive imaging unit [31.xy] 251
 Remove defective disk [61] 249
 Remove paper from standard output bin 249
 Replace all originals if restarting job. 250
 Replace cartridge, 0 estimated pages remain [88.xy] 250
 Replace cartridge, printer region mismatch [42.xy] 250
 Replace defective imaging unit [31.xy] 250
 Replace imaging unit, 0 estimated pages remain [84.xy] 250
 Replace maintenance kit, 0 estimated pages remain [80.xy] 250
 Replace unsupported cartridge [32.xy] 251
 Replace unsupported imaging unit [32.xy] 251
 Restore held jobs? 251
 Scanner automatic feeder cover open 251
 Scanner disabled by admin [840.01] 251
 Scanner disabled. Contact system administrator if problem persists. [840.02] 252
 Scanner jam, remove all originals from the scanner [2yy.xx] 252
 Scanner jam, remove jammed originals from the scanner [2yy.xx] 252
 Serial port [x] disabled [56] 252
 SMTP server not set up. Contact system administrator. 252
 Some held jobs were not restored 252
 Standard network software error [54] 252
 Standard USB port disabled [56] 253
 Supply needed to complete job 253
 Too many flash options installed [58] 253
 Too many trays attached [58] 253

Unformatted flash detected [53] 253
 Unsupported disk 253
 Unsupported option in slot [x] [55] 254
 Unsupported USB hub, please remove 243
 USB port [x] disabled [56] 254
 Weblink server not set up. Contact system administrator. 254
 printer options troubleshooting
 internal option is not detected 257
 Internal Solutions Port 259
 memory card 259
 tray problems 258
 USB/parallel interface card 259
 printer problems, solving basic 254
 printer security
 information on 208
 printing
 canceling, from the printer control panel 80
 directory list 80
 font sample list 80
 forms 74
 from a mobile device using
 AirPrint 76
 from a mobile device using Dell Mobile Print 77
 from flash drive 75
 from Macintosh 74
 from Windows 74
 menu settings page 50
 network setup page 50
 printing a directory list 80
 printing a document 74
 printing a font sample list 80
 printing a menu settings page 50
 printing a network setup page 50
 printing confidential and other held jobs
 from a Macintosh computer 78
 from Windows 78
 printing forms 74
 printing from a flash drive 75
 publications
 where to find 9
 Push Button Configuration method using 48

Q

Quality menu 191
 Quiet Mode 201

R

recipient(s)
 e-mail options 96
 recycled paper
 using 69
 recycling
 Dell products 204
 reducing a copy 85
 reducing noise 201
 Reinstall missing or unresponsive cartridge [31.xy] 250
 Reinstall missing or unresponsive imaging unit [31.xy] 251
 Remote Operator Panel
 setting up 25
 Remove defective disk [61] 249
 Remove paper from standard output bin 249
 removing printer hard disk 41
 repeat print jobs 78
 printing from a Macintosh computer 78
 printing from Windows 78
 repeating print defects appear on prints 276
 Replace all originals if restarting job. 250
 Replace cartridge, 0 estimated pages remain [88.xy] 250
 Replace cartridge, printer region mismatch [42.xy] 250
 Replace defective imaging unit [31.xy] 250
 Replace imaging unit, 0 estimated pages remain [84.xy] 250
 Replace maintenance kit, 0 estimated pages remain [80.xy] 250
 Replace unsupported cartridge [32.xy] 251
 Replace unsupported imaging unit [32.xy] 251
 replacing
 imaging unit 214
 toner cartridge 213
 replacing supplies
 staple cartridge 217

- replacing the staple cartridge 217
- reports
 - viewing 222
- Reports menu 140
- reserve print jobs 78
 - printing from a Macintosh computer 78
 - printing from Windows 78
- resolution
 - e-mail options 97
 - fax options 120
 - scan options 126
- resolution, fax
 - changing 116
- Restore held jobs? 251
- restoring factory default settings 223
- RJ-11 adapter 108

S

- safety information 7, 8
- save as shortcut
 - copy options 91
 - scan options 126
- saving paper 87
- scan options
 - darkness 126
 - file name 126
 - original size 126
 - page setup 127
 - resolution 126
 - save as shortcut 126
 - scan preview 127
 - send as 126
- scan preview
 - fax options 120
 - scan options 127
- scan screen
 - content source 127
 - content type 127
- Scan to Computer
 - setting up 125
- Scan to Network
 - setting up 24
 - using 122
- scan troubleshooting
 - cannot scan from a computer 300
 - partial document or photo scans 300
 - scan job was not successful 297
 - scanner unit does not close 287, 298

- scanning takes too long or freezes the computer 298
- scanner
 - automatic document feeder (ADF) 14
 - functions 14
 - scanner glass 14
- Scanner automatic feeder cover open 251
- Scanner disabled by admin [840.01] 251
- Scanner disabled. Contact system administrator if problem persists. [840.02] 252
- scanner glass
 - cleaning 210
 - copying using 82
- Scanner jam, remove all originals from the scanner [2yy.xx] 252
- Scanner jam, remove jammed originals from the scanner [2yy.xx] 252
- scanning
 - from a flash drive 125
 - quick copy 81
 - to a computer using the Embedded Web Server 124
 - to an FTP address 123
- scanning to a computer 125
 - using the Embedded Web Server 124
- scanning to a flash drive 125
- scanning to an FTP address
 - creating shortcuts using the computer 122
 - using a shortcut number 123
 - using the address book 123
 - using the printer control panel 123
- scanning to network destinations 122
- Schedule Power Modes
 - using 203
- security
 - modifying confidential print settings 79
- Security Audit Log menu 152
- security slot 45
- selecting a location for the printer 10
- selecting paper 68

- send as
 - e-mail options 97
 - scan options 126
- sending a fax 114
- sending a fax using the printer control panel 113
- sending an e-mail using the printer control panel 94
- sending fax
 - using shortcuts 114
 - using the address book 115
- sending fax at a scheduled time 115
- sending fax using the address book 115
- Serial port [x] disabled [56] 252
- serial printing
 - setting up 50
- Set Date/Time menu 153
- setting
 - TCP/IP address 143
- setting Hibernate Timeout 203
- setting the fax number 112
- setting the outgoing fax name 112
- setting the paper size 51
- setting the paper type 51
- setting the Universal paper size 51
- setting up e-mail alerts 222
- setting up fax
 - country- or region-specific 108
 - digital telephone service 107
 - DSL connection 105
 - standard telephone line connection 101
 - VoIP connection 106
- setting up fax and e-mail functions 290
- setting up serial printing 50
- Settings menu 187
- shipping the printer 220
- shortcuts, creating
 - e-mail 93
 - fax destination 116
 - FTP address 123
 - FTP destination 122
- showing icons on the home screen 21
- sides (duplex)
 - copy options 90
- Sleep Mode
 - adjusting 202

- SMTP server not set up. Contact system administrator. 252
 - SMTP Setup menu 148
 - software
 - Status Messenger 221
 - Status Monitor Center 221
 - Supplies Ordering Utility 211
 - Some held jobs were not restored 252
 - standard bin, using 61
 - Standard Network menu 141
 - Standard network software error [54] 252
 - standard tray
 - loading 51
 - Standard USB menu 146
 - Standard USB port disabled [56] 253
 - staple cartridge
 - replacing 217
 - statement of volatility 205
 - Status Monitor Center
 - accessing 221
 - status of parts
 - checking 211
 - status of supplies
 - checking 211
 - storing
 - paper 69
 - supplies 212
 - storing print jobs 78
 - streaked horizontal lines appear on prints 281
 - streaked vertical lines appear on prints 282
 - streaks appear 284
 - subject and message information
 - adding to e-mail 95
 - Substitute Size menu 134
 - supplies
 - checking status 211
 - checking, from printer control panel 211
 - checking, using the Embedded Web Server 211
 - ordering 211
 - storing 212
 - Supplies Ordering Utility
 - ordering supplies 211
 - supplies, ordering
 - ADF separator roller 212
 - imaging unit 212
 - maintenance kit 212
 - toner cartridges 212
 - Supply needed to complete job 253
 - supply notifications
 - configuring 222
 - supported flash drives 77
- ## T
- TCP/IP menu 143
 - the scanner does not respond 296
 - tips
 - card stock 66
 - labels, paper 66
 - letterhead 65
 - on using envelopes 65
 - transparencies 65
 - tips on using envelopes 65
 - toner cartridge
 - replacing 213
 - toner cartridges
 - ordering 212
 - toner darkness
 - adjusting 74
 - Too many flash options installed [58] 253
 - Too many trays attached [58] 253
 - touch screen
 - buttons 18
 - transparencies
 - copying on 82
 - loading, multipurpose feeder 56
 - tips 65
 - trays
 - linking 62, 63
 - loading 51
 - unlinking 62, 63
 - troubleshooting
 - an application error has occurred 301
 - cannot open Embedded Web Server 301
 - checking an unresponsive printer 254
 - contacting technical support 302
 - fax and e-mail functions are not set up 290
 - solving basic printer problems 254
 - the scanner does not respond 296
 - troubleshooting, color quality
 - prints on color transparencies appear dark when projected 271
 - troubleshooting, copy
 - copier does not respond 287
 - partial document or photo copies 289
 - poor copy quality 288
 - poor scanned image quality 299
 - scanner unit does not close 287, 298
 - troubleshooting, display
 - printer display is blank 256
 - troubleshooting, fax
 - caller ID is not shown 291
 - can receive but not send faxes 294
 - can send but not receive faxes 293
 - cannot send or receive a fax 291
 - received fax has poor print quality 295
 - troubleshooting, paper feed
 - message remains after jam is cleared 261
 - troubleshooting, print
 - error reading flash drive 262
 - held jobs do not print 264
 - incorrect characters print 266
 - incorrect margins on prints 273
 - jammed pages are not reprinted 261
 - job prints from wrong tray 266
 - job prints on wrong paper 266
 - jobs do not print 262
 - Large jobs do not collate 267
 - multiple-language PDF files do not print 261
 - paper curl 274
 - paper frequently jams 260
 - print job takes longer than expected 265
 - tray linking does not work 267
 - unexpected page breaks occur 268
 - troubleshooting, print quality
 - blank pages 269
 - characters have jagged edges 268
 - clipped pages or images 270
 - gray background on prints 272
 - horizontal voids appear on prints 283
 - print irregularities 275
 - print is too dark 277
 - print is too light 278

- printer is printing solid black
 - pages 280
- repeating print defects appear on
 - prints 276
- shadow images appear on
 - prints 271
- skewed print 279
- streaked horizontal lines appear
 - on prints 281
- streaked vertical lines 282
- toner fog or background
 - shading 285
- toner rubs off 286
- toner specks appear on prints 285
- transparency print quality is
 - poor 281
- uneven print density 286
- white streaks on a page 284
- troubleshooting, printer options
 - internal option is not
 - detected 257
 - Internal Solutions Port 259
 - memory card 259
 - tray problems 258
 - USB/parallel interface card 259
- troubleshooting, scan
 - cannot scan from a computer 300
 - partial document or photo
 - scans 300
 - scan job was not successful 297
 - scanner unit does not
 - close 287, 298
 - scanning takes too long or freezes
 - the computer 298

U

- unacceptable paper 68
- understanding the home screen
 - buttons and icons 16
- uneven print density 286
- Unformatted flash detected
 - [53] 253
- Universal Paper Size
 - setting 51
- Universal paper size
 - setting 51
- Universal Setup menu 139
- unlinking trays 62, 63
- Unsupported option in slot [x]
 - [55] 254
- Unsupported USB hub, please
 - remove 243

- USB port 45
- USB port [x] disabled [56] 254
- USB/parallel interface card
 - troubleshooting 259
- using a shortcut number
 - scanning to an FTP address 123
- using Forms and Favorites 74
- using Schedule Power Modes 203
- using shortcuts
 - sending fax 114
- using the address book 95
 - sending fax 115
- using the Embedded Web
 - Server 13
- using the touch-screen buttons 18
- Utilities menu 193

V

- verify print jobs 78
 - printing from a Macintosh
 - computer 78
 - printing from Windows 78
- vertical voids appear 284
- viewing
 - reports 222
- viewing a fax log 117
- virtual display
 - checking, using Embedded Web
 - Server 221
- voice mail
 - setting up 101
- Voice over Internet Protocol (VoIP)
 - fax setup 106
- voids appear 284
- VoIP adapter 106
- volatile memory 205
 - erasing 205
- volatility
 - statement of 205

W

- Weblink server not set up. Contact
 - system administrator. 254
- wiping the printer hard disk 206
- Wireless menu 145
- wireless network
 - configuration information 46
- wireless network setup
 - using the Embedded Web
 - Server 49

- wireless setup wizard
 - using 47

X

- XPS menu 194